

ENGINEERING  
TOMORROW



Americas

# **Weatherhead** Rubber hydraulic hose by Danfoss and fitting catalog



# Weatherhead® by Danfoss **Stronger than ever.**

For decades, Weatherhead® has moved the industry forward. Uncovering problems to be solved. Never settling for the status quo. Now, backed by the power of Danfoss, we're making major investments in product innovation, expanding manufacturing capabilities, supporting you with a world-class team. And we're just getting started.

## **Weatherhead** by Danfoss

**Industry  
leading  
fluid  
conveyance**



## product overview

Section	Page
<b>Introduction</b>	
Hose selection chart	6
STAMPED worksheet	12
Two-Tier product portfolio	28
<b>Premium hydraulic hose</b>	
Core premium braided & spiral hose	39
Premium braided & spiral hose	52
Standard braided & spiral hose	63
<b>Braided fittings</b>	
Premium - Z fittings	73
Reusable - 1R/2R fittings	143
Standard - Winner™ fittings	155
<b>Spiral fittings</b>	
Premium - 4S/6S series	169
Premium - 1W series	223
Flange, Flange kit, O-Rings	227
<b>Hose accessories</b>	
Sleeves, clamps & springs	235
Accessories to hose chart	250

Section	Page
<b>Machines &amp; tooling</b>	
Crimp machines	263
Tooling	283
Pumps	286
Conversion kits	290
Reusable machines	292
<b>Hose prep</b>	
Saws & saw blades	297
Hose proof test stands	304
Contamination control	306
<b>Cabinets &amp; storage</b>	
Danfoss branded cabinets	325
<b>Safety information</b>	
Hose safety	329
Hose selection	332
Fluid compatibility	338
Analyzing failures	349
Fluid connections	352
Assembly instructions	372
Maintenance	374
<b>Glossary &amp; index</b>	
Glossary	381
Index	386

# Explore the world of

From thermoplastic hose to data center connections, Danfoss has the hose, fittings and connectors that work.

## Connectors



- Product Categories:
- Brass Connectors
  - Flexmaster
  - FLOCS
  - Quick Disconnect Couplings
  - Steel Adapters
  - Swivels
  - Tube Fittings

## Fuel, air conditioning, thermoplastic & specialty (FACTS)



- Product Categories:
- A/C & Refrigeration
  - Airbrake
  - Beverage Tubing
  - Engine/Fuel
  - Performance Products
  - PTFE
  - Railway
  - Silicone
  - Socketless
  - Specialty
  - Subsea Oil & Gas
  - Thermoplastic



## Industrial hose



### Product Categories:

- Air & Multipurpose
- Chemical
- Food & Beverage
- Material Handling
- Oil & Petroleum
- Specialty
- Steam
- Water

## Rubber hydraulic hose & fittings (RHHF)



### Product Categories:

- Braided Hose & Fittings
- Spiral Hose & Fittings
- Tools, Machines & Accessories

Hose selection chart

**How to use chart:** Locate the hose I.D. required and move to the right to the correct pressure. Then move up or down in this column for data on material, temperature, etc. to quickly determine whether the hose meets your requirements.

For complete information on any hose refer to hose catalog page number.

Core hoses are indicated with icons:

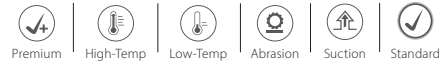

**Selection of hose:** Selection of the proper hose for the application is essential to the proper operation and safe use of the hose and related equipment. Inadequate attention to selection of the hose for your application can result in hose leaking, bursting, or other failure which can cause serious bodily injury or property damage from spraying fluids or flying projectiles. You should carefully review the information in this catalog.

Hose selection chart								
Hose	H180	H145R	H190H	H280	H881	H290H	H245L	
Page	39	40	41	42	43	44	45	
Usage	✓+	⚙️	🌡️	✓+	✓+	🌡️	🌡️	
	Low to medium pressure hydraulic & water-based fluids	Medium pressure hydraulic & water-based fluids in abrasive applications	Hydraulics, crude, fuel and lubricating oils, gasoline, water and phosphate ester base hydraulic fluids	Transfer of medium to high pressure hydraulic & water-based fluids	Hydraulic system with petroleum and water glycol based fluids for lubricating oils	Hydraulics, crude, fuel and lubricating oils, gasoline, water and phosphate ester base hydraulic fluids	Low temperature hydraulic system service with petroleum and water-based fluids, for general industrial service.	
<b>Certifications</b>								
SAE	SAE 100R17 SAE 100R1	SAE 100R17	SAE 100R1	SAE 100R16	SAE 100R16 SAE 100R19	SAE 100R2	SAE 100R16	
EN	EN 857 1SC performance		EN 853	EN 857 2SC	EN 857 2SC	EN 853 2SN	EN 857 2SC	
ISO	ISO 1436 ISO 18752	ISO 18752		ISO 18752 ISO 11237	ISO 18752	ISO 1436	ISO 11237-1	
OTHER	ABS DNV MSHA USCG	MSHA	ABS MSHA	ABS DNV MSHA USCG	MSHA	ABS MSHA	MSHA	
<b>Hose Specifications</b>								
Temp Range	-46° to 126° C -50° to 260° F	-40° to 100° C -40° to 212° F	-40° to 150° C -40° to 302° F	-46° to 126° C -50° to 260° F	-46° to 126° C -50° to 260° F	-40° to 150° C -40° to 302° F	-57° to 100° C -70° to 212° F	
Fittings	Z series 1R Series	Z series	Z series	Z series 2R Series	Z series	Z series	Z series	
<b>Hose Construction</b>								
Inner Tube	Nitrile	Nitrile	CPE	Nitrile	Dura-Pulse	CPE	Nitrile	
Reinforcement	1 wire braid	1 wire braid or 2 wire braid	1 wire braid	2 wire braid	2 wire braid	2 wire braid	2 wire braid	
Cover	Dura-Tuff	Bruiser	CPE	Dura-Tuff	Dura-Tuff	CPE	Rubber Cover	
<b>DASH</b>	<b>HOSE ID</b>	<b>H180</b>	<b>H145R</b>	<b>H190H</b>	<b>H280</b>	<b>H881</b>	<b>H290H</b>	<b>H245L</b>
-4	1/4	3,700	3,050	3,250	6,500	6,525	5,800	6,000
-6	3/8	3,400	3,050	3,125	5,800	5,800	5,000	5,000
-8	1/2	3,200	3,050	2,550	5,000	5,220	4,250	4,500
-10	5/8	2,025	3,050	2,050	4,000	5,075	3,650	4,000
-12	3/4	2,000	3,050	1,800	3,500	4,785	3,125	3,500
-16	1	1,500	3,050	1,300	3,000	4,060	2,550	2,800
-20	1-1/4	1,000		950	2,500	2,500	2,250	2,300
-24	1-1/2	750		725	2,000	2,000	1,800	2,000
-32	2	600		580	1,600	1,600	1,525	1,500
-40	2-1/2							
-48	3							
-64	4							

**How to use chart:** Locate the hose I.D. required and move to the right to the correct pressure. Then move up or down in this column for data on material, temperature, etc. to quickly determine whether the hose meets your requirements.

For complete information on any hose refer to hose catalog page number.

Core hoses are indicated with icons:



Hose selection chart							
Hose	H430	H430R	H525H	H471	H810L	H600	
Page	46	47	48	49	50	51	
Usage							
	Hydraulic system service with petroleum and water based fluids, for general use.	High abrasion industrial and hydraulic system applications with petroleum and water-based fluids	Petroleum and fire-resistant hydraulic fluids, fuel and lubricating oils, gasoline, water and other industrial fluids	High pressure hydraulic system service with petroleum and water-based fluids, for general industrial service.	Hydraulic system service with petroleum based fluids for use in cold environments.	High pressure hydraulic system service with petroleum and water-based fluids, for general industrial service	
<b>Certifications</b>							
SAE	SAE 100R12	SAE 100R12		SAE 100R13	SAE 100R15	SAE 100R15	
EN	EN 856 R12	EN 856 R12		EN 856 R13	EN 856 4SH Performance	EN 856 4SH EN 856 R13	
ISO	ISO 3865 ISO 18752	ISO 18752		ISO 3862 R13		ISO 18752	
OTHER	ABS DNV	MSHA USCG	MSHA	MSHA	MSHA USCG	MSHA	MSHA
<b>Hose Specifications</b>							
Temp Range	-40° to 126° C -40° to 260° F	-40° to 121° C -40° to 250° F	-40° to 149° C -40° to 300° F	-40° to 127° C -40° to 260° F	-57° to 100° C -70° to 212° F	-40° to 127° C -40° to 260° F	
Fittings	4S Series	4S Series	4S Series	4S Series 6S Series	4S Series 6S Series	4S Series 6S Series 1W Series	
<b>Hose Construction</b>							
Inner Tube	Nitrile	Nitrile	CPE	Nitrile	Nitrile	Nitrile	
Reinforcement	4 wire spiral	4 wire spiral	4 wire spiral	4 wire spiral or 6 wire spiral	4 wire spiral or 6 wire spiral	4 wire spiral or 6 wire spiral	
Cover	Dura-Tuff	Bruiser	CPE	Dura-Tuff	Rubber Cover	Dura-Tuff	
<b>DASH</b>	<b>HOSE ID</b>	<b>H430</b>	<b>H430R</b>	<b>H525H</b>	<b>H471</b>	<b>H810L</b>	<b>H600</b>
-4	1/4						
-6	3/8	6,500	5,500			6,100	
-8	1/2	6,000	5,000			6,100	
-10	5/8	6,000	5,000			6,100	
-12	3/4	5,500	4,050	5,000	5,100	6,100	6,100
-16	1	5,100	4,050	5,000	5,100	6,100	6,100
-20	1-1/4	4,500	3,050	3,500	5,100	6,100	6,100
-24	1-1/2	4,000	2,550	3,500	5,100	6,100	6,100
-32	2	4,000	2,550	3,250	5,100	6,100	6,100
-40	2-1/2						
-48	3						
-64	4						

Hose selection chart

**How to use chart:** Locate the hose I.D. required and move to the right to the correct pressure. Then move up or down in this column for data on material, temperature, etc. to quickly determine whether the hose meets your requirements.

For complete information on any hose refer to hose catalog page number.

Core hoses are indicated with icons:



**Hose selection chart**

Hose	H190	H290	H145	H545	H400	H421	
Page	52	53	54	55	56	57	
Usage	Hydraulic systems with petroleum and water-glycol base fluids, for lubricating oils and water.	Hydraulic system service with petroleum & waterbased fluids, for general industrial service.	Ideal for use in high pressure lines on off-road construction equipment and other high pressure applications where small bend radius is needed	3,000 PSI constant pressure hose with abrasion resistant cover, ideal for logging, construction, mining and other off highway applications	Industrial and hydraulic system applications with petroleum and water-based fluids. Recommended for use on construction, forestry, and other off-highway vehicles	Hydraulic jacking system service with petroleum and water-based fluids. Meets the performance requirements of the MHIS IJ100.	
<b>Certifications</b>							
SAE	SAE 100R1	SAE 100R2	SAE 100R2 SAE 100R17		SAE 100R19 Performance		
EN	EN 8583 1SN performance	EN 853 2SN Performance	EN 853 2SN Performance				
ISO	ISO 1436 1SN	ISO 1436 2SN (-12, -16)					
OTHER	ABS MSHA USCG	MSHA USCG	MSHA USCG		MSHA	MSHA IJ100	
<b>Hose Specifications</b>							
Temp Range	-40° to 127° C -40° to 260° F	-40° to 126° C -40° to 260° F	Varies according to size - see hose page	-40° to 121° C -40° to 250° F	-40° to 100° C -40° to 212° F	-40° to 49° C -40° to 120° F	
Fittings	Z Series	Z Series 2R Series (size dependent)		Z series	Z series	Z series	
<b>Hose Construction</b>							
Inner Tube	Nitrile	Nitrile		Nitrile	Nitrile	Nitrile	
Reinforcement	1 wire braid or 2 wire braid	2 wire braid		1 wire braid or 2 wire braid	2 wire braid	2 wire braid	
Cover	Dura-Tuff	Dura-Tuff	Neoprene	Bruiser	Dura-Tuff	Dura-Tuff	
<b>DASH</b>	<b>HOSE ID</b>	<b>H190</b>	<b>H290</b>	<b>H145</b>	<b>H545</b>	<b>H400</b>	<b>H421</b>
-4	1/4	3,700	6,500	3,045	3,000	4,000	10,000
-6	3/8	3,400	5,800	3,045	3,000	4,000	10,000
-8	1/2	2,900	5,000	3,045	3,000	4,000	
-10	5/8	2,050	4,000	3,045	3,000	4,000	
-12	3/4	2,000	3,500	3,045	3,000	4,000	
-16	1	1,500	3,000	3,045	3,000		
-20	1-1/4	1,000	2,500				
-24	1-1/2	750	2,000				
-32	2	600	1,600				
-40	2-1/2						
-48	3						
-64	4						

**How to use chart:** Locate the hose I.D. required and move to the right to the correct pressure. Then move up or down in this column for data on material, temperature, etc. to quickly determine whether the hose meets your requirements.

For complete information on any hose refer to hose catalog page number.

Core hoses are indicated with icons:



Hose	H850	H464	H039	H039H	
Page	58	59	60	61	
Usage	Ultra high pressure applications, hydraulic systems with petroleum and water-glycol based fluids, lubricating oils and water.	Hydraulic systems with petroleum and water-glycol based fluids, for lubricating oils and water	 Suction and transfer applications for petroleum hydraulic fluids, fuel, lubricating oils, gasoline, water and many other industrial fluids.	Suction and transfer applications for petroleum and fire resistant hydraulic fluids, fuel, lubricating oils, gasoline, water and many other industrial fluids.	
<b>Certifications</b>					
SAE	SAE 100R15		SAE 100R4	100R4	
EN	EN 856 R13	EN 856 4SH	EN 45545		
ISO	ISO 18752	ISO 3862 4SH ISO 18752			
OTHER	MSHA	MSHA	ABS MSHA USCG	MSHA	
<b>Hose Specifications</b>					
Temp Range	-40° to 100° C -40° to 212° F	-40° to 100° C -40° to 212° C	-40° to 135° C -40° to 275° F	-40° to 150° C -40° to 300° F	
Fittings	1W Series	1W Series 4S Series	Z series 327E Series 4S Series	Z series 327E Series	
<b>Hose Construction</b>					
Inner Tube	Nitrile	Nitrile	CPE	CPE	
Reinforcement	4 wire spiral or 6 wire spiral	4 wire spiral	2 fiber ply with helical wire	2 fiber ply with helical wire	
Cover	Dura-Tuff	Dura-Tuff	Dura-Tuff	High-Temp	
<b>DASH</b>	<b>HOSE ID</b>	<b>H850</b>	<b>H464</b>	<b>H039</b>	<b>H039H</b>
-4	1/4				
-6	3/8				
-8	1/2				
-10	5/8	7,250			
-12	3/4	7,250	6,100	305	305
-16	1	7,250	6,100	245	255
-20	1-1/4	7,250	5,100	205	205
-24	1-1/2		4,350	150	160
-32	2		3,650	100	100
-40	2-1/2			60	65
-48	3			60	60
-64	4				50



## Hose selection chart

**How to use chart:** Locate the hose I.D. required and move to the right to the correct pressure. Then move up or down in this column for data on material, temperature, etc. to quickly determine whether the hose meets your requirements.

For complete information on any hose refer to hose catalog page number.

Core hoses are indicated with icons:

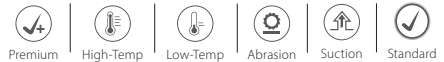

Hose selection chart							
Hose	EC115	EC215	EC118	EC415	EC420	WH004	
Page	66	67	68	69	70	71	
Usage							
	Hydraulic system service with petroleum and water-based fluids and general industrial service.	Hydraulic system service with petroleum and water-based fluids, for general industrial service.	Hydraulics, gasoline, air, crude, fuel and lubricating oils	Hydraulic systems service with petroleum and water based fluids, for general use.	Suitable for use in hydraulic systems with high peak pressures and arduous operating conditions.	Suitable for use in suction applications for hydraulics, crude fuel, lubricating oils, gasoline, air, water and chemical transfer	
<b>Certifications</b>							
SAE			100R17	100R12	100R13	100R4 Performance	
EN	EN 857 1SC (-4 to -16)	EN 857 2SC		EN 856 R12	EN856 R13		
ISO		18752	18752	18752	18752		
OTHER	DNV MSHA USCg	DNV MSHA USCg	MSHA USCg	MSHA USCg	MSHA USCg	MSHA	
<b>Hose Specifications</b>							
Temp Range	-40° to 100° C -40° to 212° F	-40° to 100° C -40° to 212° F	-40° to 100° C -40° to 212° F	-40° to 121° C -40° to 250° F	-40° to 121° C -40° to 250° F	-40° to 100° C -40° to 212° F	
Fittings	Z series 2 pc Winner 1R Series	Z series 2 pc Winner 2R Series	Z series 2 pc Winner 1R Series (-4 to -8)	4S Series	4S Series 6S Series	Z series, 32E Series, 2 pc Winner Series & 4T Optimum	
<b>Hose Construction</b>							
Inner Tube	Nitrile	Nitrile	Nitrile	Nitrile	Nitrile	Nitrile	
Reinforcement	1 wire braid	2 wire braid	1 wire braid or 2 wire braid	4 wire spiral	4 wire spiral or 6 wire spiral	2 fiber ply with helical wire	
Cover	Nitrile	Nitrile	Nitrile	Nitrile	Nitrile	Abrasion-resistant nitrile	
<b>DASH</b>	<b>HOSE ID</b>	<b>EC115</b>	<b>EC215</b>	<b>EC118</b>	<b>EC415</b>	<b>EC420</b>	<b>WH004</b>
-4	1/4	3,250	5,800	3,050			
-6	3/8	2,600	5,000	3,050	4,050		
-8	1/2	2,300	4,000	3,050	4,050		
-10	5/8	1,900	3,650	3,050	4,050		
-12	3/4	1,525	3,125	3,050	4,050	5,100	305
-16	1	1,275	2,400	3,050	4,050	5,100	245
-20	1-1/4	925	1,800		3,050	5,100	205
-24	1-1/2	725	1,450		3,000	5,100	150
-32	2	580	1,300		3,000	5,100	100
-40	2-1/2						60
-48	3						60
-64	4						



# worksheet

Danfoss recommends using the **STAMPED** process to aid in determining the correct hose and coupling for your application. This worksheet is designed to help you organize information for determining the best hose for a given application. The questions are based on the hose selection factors described in this guide.

When selecting a hose, always use this worksheet in conjunction with this guide. Read all instructions concerning the hose you are selecting. If any questions arise contact Danfoss technical support at 1-888-258-0222.

**STAMPED**

**S - Size**  
(I.D., O.D. and length)

**T - Temperature** of material conveyed and environmental

**A - Application,** the conditions of use

**M - Material** being conveyed, type and concentration

**P - Pressure** to which the assembly will be exposed

**E - Ends;** style, type, orientation, attachment methods, etc.

**D - Delivery** testing, quality, packaging, and delivery requirements

Flow (cubic feet per minute) requirements? \_\_\_\_\_

See RMA Water Discharge table.

Hose I.D. requirements given the flow requirements? \_\_\_\_\_

Pressure drop? \_\_\_\_\_

Length requirements (excluding hose ends)? \_\_\_\_\_

Temperature range of material to be transferred?

Min. \_\_\_\_\_ Max. \_\_\_\_\_ Average \_\_\_\_\_

Year-round external environment temperature range? \_\_\_\_\_

Cleaning temperature?

\_\_\_\_\_

If the application is new, what service is to be performed?

\_\_\_\_\_  
\_\_\_\_\_  
\_\_\_\_\_

Internal and external environment consideration. Internal environment relates to the material being conveyed. External environment relates to anything originating from outside the hose.

Check all that apply.

- |  |   |
|--|---|
| <input type="checkbox"/> Abrasive materials (conveyants and external)    | <input type="checkbox"/> Ozone              |
| <input type="checkbox"/> Petroleum products (aromatics, aliphatics, etc) | <input type="checkbox"/> Acids/caustics     |
| <input type="checkbox"/> Materials that could cut or gouge hose          | <input type="checkbox"/> Animal fats (oils) |
| <input type="checkbox"/> Solvents  | <input type="checkbox"/> Sparking or flames |
| <input type="checkbox"/> Cleaning with steam                             |   |

Material to be transferred? \_\_\_\_\_

Material concentration (%)? \_\_\_\_\_

What hose cleaning solution(s) will be used? \_\_\_\_\_

If you have any questions, please contact Danfoss Technical Support at 1-888-258-0222.

What working pressure is required? \_\_\_\_\_

Are pressure surges involved in this application? How high? \_\_\_\_\_

What safety factor is required? \_\_\_\_\_

Is this a suction application? What vacuum rating is required? \_\_\_\_\_

End \_\_\_\_\_

Material \_\_\_\_\_

Attachment Method \_\_\_\_\_

Qty. required \_\_\_\_\_ Date required \_\_\_\_\_ Pkg. requirements \_\_\_\_\_

Testing Required -  No  Yes If Yes, Type: \_\_\_\_\_

Certification Required -  No  Yes If Yes, Type: \_\_\_\_\_

Will the selected hose need to possess any of the following features:

Branding information needed on the hose? \_\_\_\_\_

Color coding? \_\_\_\_\_

Any special designations required by agencies or associations? \_\_\_\_\_

Will any regulatory agency approvals be required? If yes, which one(s)? \_\_\_\_\_

Non-conductive rubber needed to prevent transmittal of electricity? \_\_\_\_\_

Static wire or static-dissipating tube to prevent static electricity buildup and discharge sparks? \_\_\_\_\_

Pin-pricked cover to resist blistering when transferring hot materials or air/gases under pressure? \_\_\_\_\_

Abrasion sleeve or guard? \_\_\_\_\_

Heat shield? \_\_\_\_\_

Sub-zero exposure resistance? \_\_\_\_\_

Special assembly requirements? \_\_\_\_\_

Continuous transfer service or intermittent service? \_\_\_\_\_

Flexibility: Do space restrictions exist where the hose will be used? \_\_\_\_\_

Bend Radius: of the hose relative to space in which hose will be used? \_\_\_\_\_

Considering the intended use of the hose, how flexible will it need to be (check one)?

Extremely flexible       Slightly flexible       Not an issue

Weight: How will the hose be handled during use, if at all? \_\_\_\_\_

How important is the weight of the hose going to be in this application (check one)?

Very important       Slightly important       Not an issue

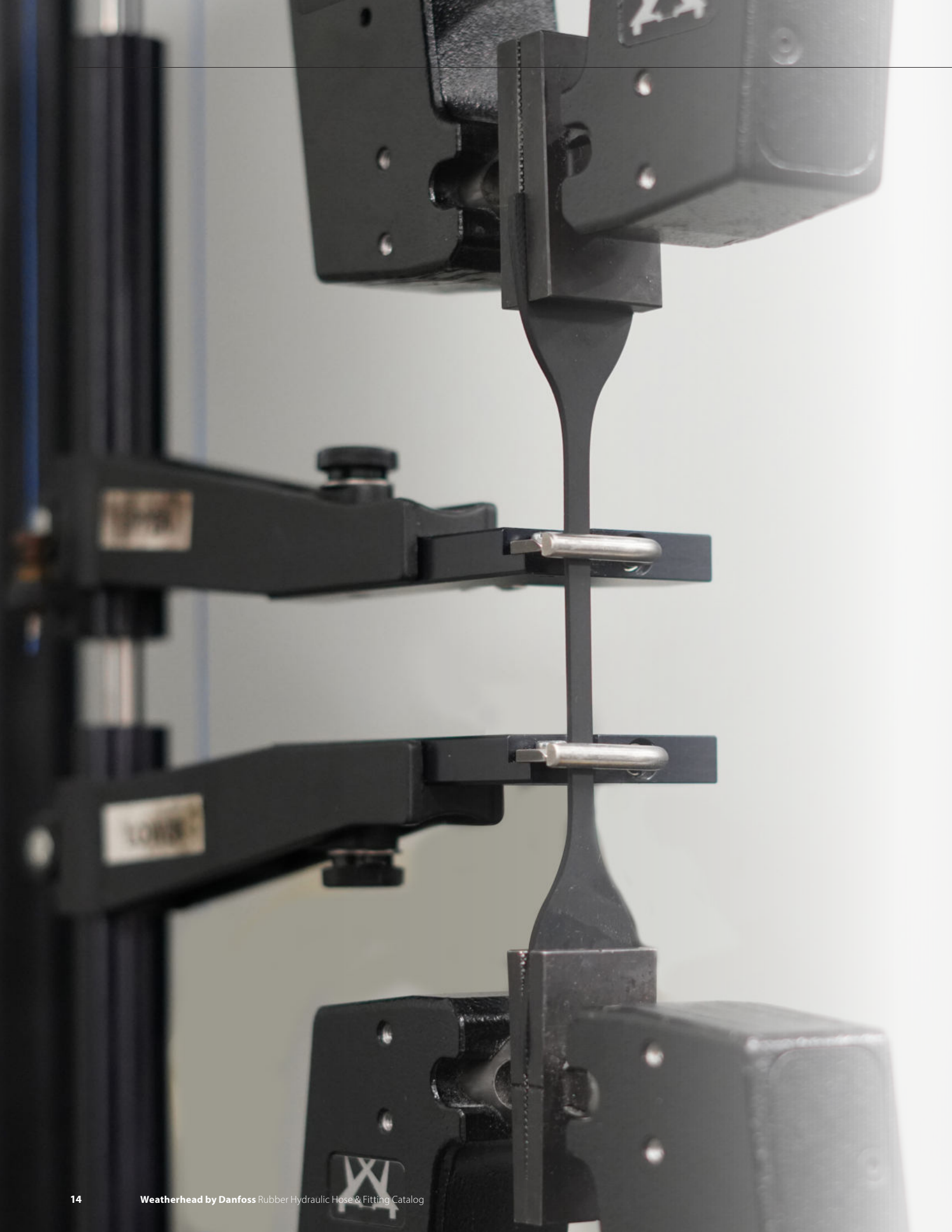



# Danfoss

Where innovation and technology meet



## Applications

A Product Applications Engineer is responsible for performing a wide variety of engineering and technical tasks. They review all customer product specifications, including drawings, contracts, and project details. They are the main technical resources throughout the sales process. The Product Applications Engineer identifies and designs complex products and solutions, determining manufacturing feasibility and costs for specific customer applications and quotations.

## Engineering Lab

The Engineering Lab is a place of learning and discovery for our technical team. This area includes our current crimp machine line up where we can build test samples and prove out new products and tooling on our crimp equipment. It also includes two of our 3D printers that we use for rapid prototypes, proving designs and developing new methods of manufacturing components. There is also space to perform product tear downs, review and analysis as well as machining capabilities for custom tooling, fixtures and cutaways.

## Environmental

Fluid Conveyance Products are exposed to many harsh environments and we need to be able to duplicate some of these conditions. Environmental chambers are machines we use to simulate extreme temperature, humidity, vibration, flexing and pressurization conditions. The environmental room is filled with six environmental chambers with varying capabilities. While all the chambers can be programmed with a high/low temperature profile, two of the chambers have vibration capabilities, one has a mechanical

flex capability and two have humidity capabilities. Environmental testing is performed to either industry specifications, customer specifications or internally developed test protocols. As an added feature, a power unit can be brought to the chambers to perform impulse testing while at varying environmental conditions.

Our ISO/TS 16949 approved and A2LA certified Test Lab provides a suitable environment to conduct laboratory testing in support of new product development, ongoing customer support and internal continuous improvement activities. Our staff includes experienced Technicians, Hydraulics Systems experts, Electrical expertise, LabView expertise, in house Gauging and Calibration, Quality and Maintenance. We are fully capable of designing and developing all our test equipment from simple test fixtures to complex impulse machines.

The machines within this area are designed to perform the core hose tests of impulse and burst. Impulse testing is a fatigue test where hose is repeatedly exposed to high pressure pulses for a high number of cycles while at its highest operating temperature and smallest bend radius. These extreme conditions ensure hoses meet endurance requirements. Burst is a one time pressure test where hose is taken to failure and required to meet a 4 to 1 safety factor. Other testing that takes place in this area includes vibration, tensile, volumetric expansion and air brake flex testing. While not as common as burst and impulse, these tests are needed to support the vast array of industries that the Fluid Conveyance product lines serve.

The Maumee Materials Science laboratory offers the formulation development of novel thermoset and thermoplastic elastomers alongside expertise in testing, chemical compatibility and QC analysis.

The ovens that occupy most of this room's floor space are utilized for a variety of high temperature tests including high temperature aging, hot oil circulation, high temperature impulse and high temperature burst. Testing to these protocols ensures our products will perform even when run at their extreme rated operating temperatures.

Abrasion to a hose cover will expose the steel reinforcement wires causing corrosion and eventually hose failure. The Fluid Conveyance product group offers a variety of hose covers from entry level low abrasion resistance to premium products that offer very high abrasion resistance. To characterize the abrasion resistance of a hose cover, we use an abrasion tester designed to run testing per ISO-6945.

Salt spray is another standardized test protocol run in this room to test plating corrosion resistance. Plating is a significant factor for Fluid Conveyance because most of our fitting and adapter product lines are Zinc plated steel.

The Maumee Pilot Plant generates prototype hose based on engineering specifications and used in the Concept Assessment and Design Suitability stages of development.

## Danfoss term

### Danfoss brand definitions

Premium brand hose

**Ultra-abrasion** resistant hose cover; 700x greater abrasion resistance than the industry standard.

Plating technology offering three times the **corrosion protection** on carbon steel fittings, compared to competitive hose fittings – up to 1000 hours of corrosion protection. Used on premium fitting series such as Z, Z and 4S/6S series.

A patented **inner-tube** compound providing five times longer life than standard 2SC hoses. It is slow to age and has a low compression set, which provides better sealing and leak free performance.

Patented innovation that eliminates the hose assembly **cool-down leakage**, while extending hose assembly life and reducing equipment downtime.

Premium **abrasion**-resistant hose cover; 8x greater abrasion resistance than industry standard.

Ultra-performance, premium hose offering **high pressure capabilities** with extended life and 50% better **bend radius** than EN standard.

A monitoring system that detects impending hydraulic hose failure and alerts operators and maintenance crews so they can schedule maintenance and plan downtime. The system continuously monitors hose condition via electrical signals and generates an alert when the hose starts to experience internal fatigue.

System that matches hose to fittings.

Braided-Match number of rings (O) on layline with number of rings on fitting

Spiral-Match either 4S or 6S on layline with corresponding mark on fitting

Braided & Spiral-Match hose dash size with size on fitting

Specialized fitting that provides an o-ring seal at the face of the fitting designed to eliminate leaks in high pressure systems.

Standard tier brand hose & fittings

Spiral hose offering 50% of SAE R13/R15 **bend radius** in demanding **high impulse** applications

### Fitting definitions

Premium reusable fitting series' name for one and two-wire braided hose products. Suitable for use on premium and standard products.

Premium internal skive, two-piece fitting series' name for select core spiral hoses used to achieve a higher level of performance. Suitable for use on premium and standard products.

Premium series' name for "over-the-cover" (OTC) style fitting.

Premium one-piece fitting series' name for core spiral hose products. Suitable for use on premium and standard products.

High pressure fitting series' that makes hose line connection quick and easy, without the need for assembly tools.

Standard tier fitting series. Does not use dura-kote plating technology. Suitable for use on standard products and selectively on premium products.

Non-skive standard tier fitting series. Does not use Dura-Kote plating technology. Suitable for use on standard products and selectively on premium products.

Weatherhead one-piece fitting series' name for core, braided hose products. It corresponds with the printing on both the hose layline and fitting. "Through the cover" (TTC) is a legacy series' name. Suitable for use on premium and standard products.

## Industry terms

A term used to describe non-reusable fitting component parts or complete assemblies for braided and spiral hoses. Core series are: Z, 327E, 4S and 6S.

A fitting designed to be attached to a hose without crimping or swaging. This fitting is not always a reusable type fitting.

A device attached to the end of the hose to facilitate connection. "Hose-end" and "coupling" are equivalent terms in the industry.

The maximum pressure for which the hose assembly is designed. Note: "operating pressure" is an equivalent term but should not be used in copy.

The portion of the fitting that goes directly into the inner diameter of the inner tube of the hose. It extends out of the hose and into the connecting end. Also known in the industry as a "stem" or "insert".

Refers to hose and fitting combinations that does not require removing part of the hydraulic hose cover and/or inner tube prior to attaching fittings. Also known in the industry as "no-skive".

The portion of a fitting that is compressed by crimping to seal the hose onto the fitting barbs and create a permanent attachment. Also known as "collar" and "ferrule" in the industry.

## Key fluid conveyance terms

Hose series reinforced with a single steel braid

Hose series reinforced with two steel braids

Hose series reinforced with four wires

Hose Series reinforced with six wires

Defines the level of abrasion-resistance a cover offers. Danfoss has three levels: standard, premium (Dura-Tuff) and ultra (Bruiser)

Danfoss' designated term for premium core products with a max temperature rating of at least 150°C (300°F).

Danfoss' designated term for premium core products with a max temperature rating of at least -57°C (-70°F).

Products that **exceed** industry specifications. For Danfoss, distinctions from standard tier are made with abrasion resistance, temperature range, impulse cycles and ISO 18752 rating.

Products that **meet** industry specifications.

Active products that tend to be used for more niche applications.

Danfoss

TM

Your information headquarters

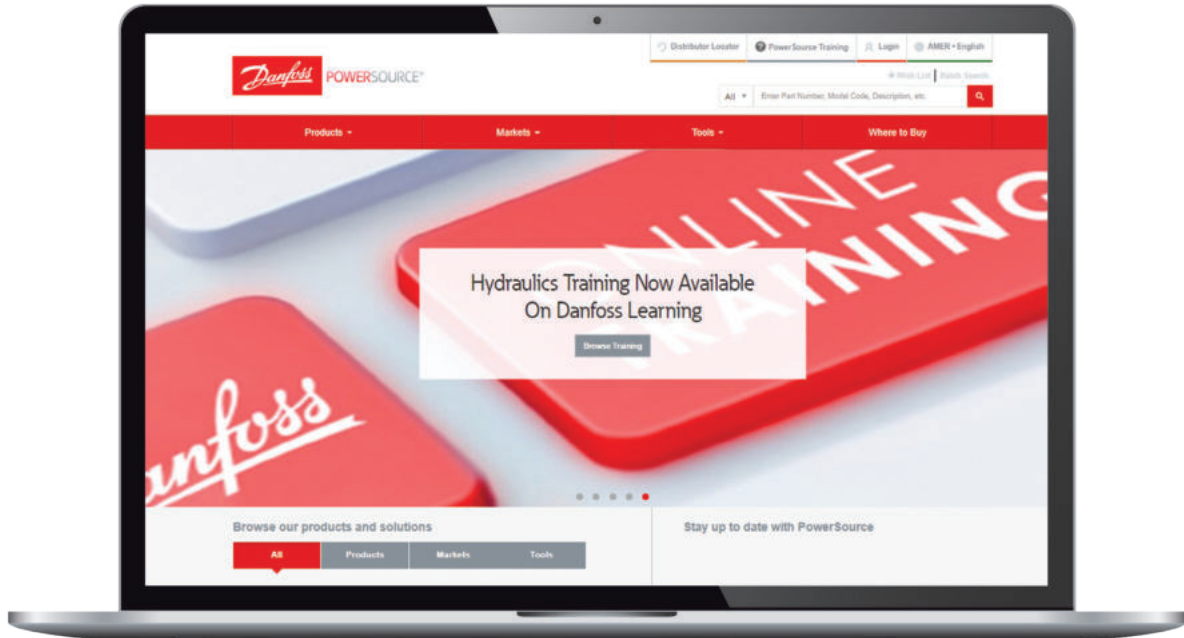

## Putting fluid conveyance information at your

1. Searchable fluid conveyance product information:
  - Part numbers
  - Sizes
  - Performance and specifications
  - Branding information
2. Literature and videos
3. Product value propositions
4. Crimp specifications
5. Competitor cross reference tool
6. Coupling cross reference tool
7. Custom bin label tool
8. 2D/3D cad models
9. Hose assembly configurator
10. Marketplace (authenticated PowerSource only)
11. List prices and lead times (authenticated PowerSource only)

To access these tools and more, visit and log in to PowerSource from [Danfosspowersource.com](http://Danfosspowersource.com) and then select tools.

## Custom bin labels

Get your custom bin labels today!

Danfoss has created a solution for all your instant bin label needs from the convenience of your office in just four simple steps.

- 1 **Select template**  
Choose the template.
- 2 **Enter part numbers**  
Enter part numbers OR upload your own file of part numbers.
- 3 **Choose the layout**  
Configure label with or without barcode.
- 4 **Print label set**  
Generate a PDF to preview and print your label set.

For best results use the product code FF00000, available through Taylor Communications. Individual labels are 2 9/16" x 11/16".

This custom bin label web solution can be found at: [Danfosspowersource.com](http://Danfosspowersource.com) > PowerSource > Tools > Custom Bin Labels

The screenshot shows the Danfoss Custom Bin Labels web application. At the top, there is a navigation bar with the Danfoss logo, "POWERSOURCE", and links for "Distributor Locator", "PowerSource Training", and "Login". Below this is a search bar with "AMER • English" selected. The main content area is titled "Custom Bin Labels" and includes a "Product Code: FF00000" banner. The interface is divided into four steps:

- Step 1: Select Template**: A dropdown menu shows "Taylor Communications - 2 9/16" x 11/16"
- Step 2: Enter Part Numbers**: Two options are provided: "Enter a List" (a text area for pasting part numbers) and "Upload List" (a file upload button). A "Download Template (.xlsx)" link is also present.
- Step 3: Choose Layout**: Two layout options are shown: "Barcode" (with a barcode) and "No Barcode" (with a plain label for "4SA6MB6 Male O-ring Boss").
- Step 4: Print Label Set**: A "Generate PDF for Preview/Print" button is visible at the bottom.



Fitting options



## Standard and premium fittings -

**Braided or spiral, premium or standard, there is a Danfoss fitting designed for your application.**

Braided hose fittings		Features:
<p>Z series braided fittings</p> 	<ul style="list-style-type: none"> <li><b>Dura-Kote™</b> plating technology for up to 1,000 hours of corrosion resistance</li> <li>Bite the wire technology for best in class connection and sealing</li> <li>Class zero leakage SAE J1176 on approved hose styles</li> <li>Over 550 Z series part numbers available</li> <li>Danfoss' <b>MatchMate®</b> program provides identification markings on the hose, hose fittings, and crimp dies for quick and easy assembly</li> </ul>	
<p>Two-piece Winner fittings</p> 	<ul style="list-style-type: none"> <li>Non-skive, two-piece crimp fitting</li> <li>One nipple part number for EC115, EC215 and EC118 standard hoses</li> <li>Meets industry specifications when used with the EC115, EC215 and EC118 standard hoses</li> <li>Clear silver hexavalent chromium-free plating</li> <li>Carbon steel material</li> </ul>	
Spiral hose fittings		Features:
<p>4S/6S spiral fittings</p> 	<ul style="list-style-type: none"> <li><b>Dura-Kote</b> plating technology for up to 1,000 hours of corrosion resistance</li> <li>Danfoss patent-pending <b>Dura-Seal™</b> technology eliminates hose assembly cool-down leakage</li> <li>Class zero leakage SAE J1176 on approved hose styles</li> <li>Danfoss' <b>MatchMate</b> spiral-hose/fitting identification system program provides identification markings on the hose, hose fittings, and crimp dies for quick and easy assembly</li> </ul>	
<p>1W internal skive spiral fittings</p> 	<ul style="list-style-type: none"> <li>Internal skive high-performance spiral fitting with design-related sockets</li> <li>Blow-off prevention for critical applications</li> <li>Designed to withstand high-pressure environments, with a capacity of up to working 500 bar (7250 psi).</li> <li>Tested to two million flex impulse cycles, proving their durability and reliability over the long-term.</li> <li>Class 0 cool down leakage per SAE J1176</li> <li>Double O-ring <b>Dura-Seal</b> for sizes -20 to -32 providing extra protection and durability for large size hoses.</li> </ul>	
Reusable hose fittings		Features:
<p>Reusable fittings</p> 	<ul style="list-style-type: none"> <li><b>Dura-Kote</b> plating technology for up to 1,000 hours of corrosion resistance</li> <li>Engineered to provide peak performance with Danfoss' core braided hose products</li> <li>Can be assembled in the field without special tooling</li> <li>Reduced downtime</li> <li>Quick repair</li> </ul>	

# Dura-Kote and Dura-Seal technology



**3X** Carbon steel corrosion protection

**Dura-Kote plating technology**

Hose fittings that will now offer 3x the corrosion protection on carbon steel fittings as compared to competitive hose fittings. Danfoss' Dura-Kote fittings provide up to 1000 hours of corrosion protection. This is a huge step forward in metal fitting corrosion protection. (Only on Z series and 4S/6S fittings)



4S/6S fitting

**Class 0** Cool-down leakage protection

**Dura-Seal technology**

This patent-pending innovation from Danfoss eliminates hose assembly cool-down leakage, while extending hose assembly life, reducing equipment down-time. (Only on 4S/6S fittings)

## Need

Danfoss has the answer.

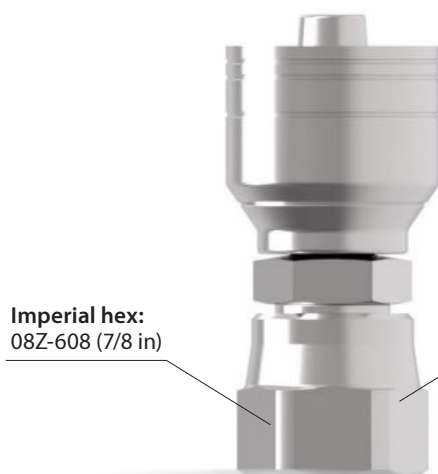

**Imperial hex:**  
08Z-608 (7/8 in)

**Metric hex:**  
08Z-608M (22 mm)

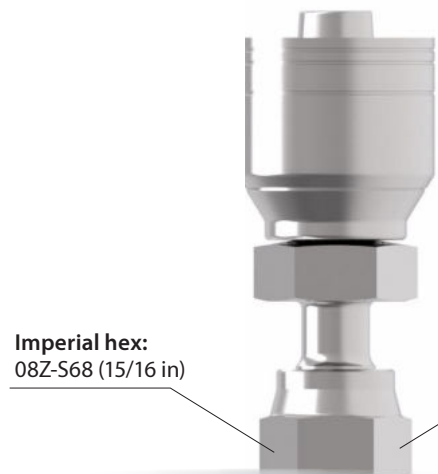

**Imperial hex:**  
08Z-S68 (15/16 in)

**Metric hex:**  
08Z-S68M (24 mm)

- JIC • ORS • Many imperial JIC and ORS fittings have a metric equivalent

\*Danfoss metric fittings are not listed in this catalog, please contact customer service for more information.

# Crimp specs

Find your crimp specs quickly and easily with the PowerSource Crimp Spec tool. You can create a custom crimp chart from your desktop following these simple steps.

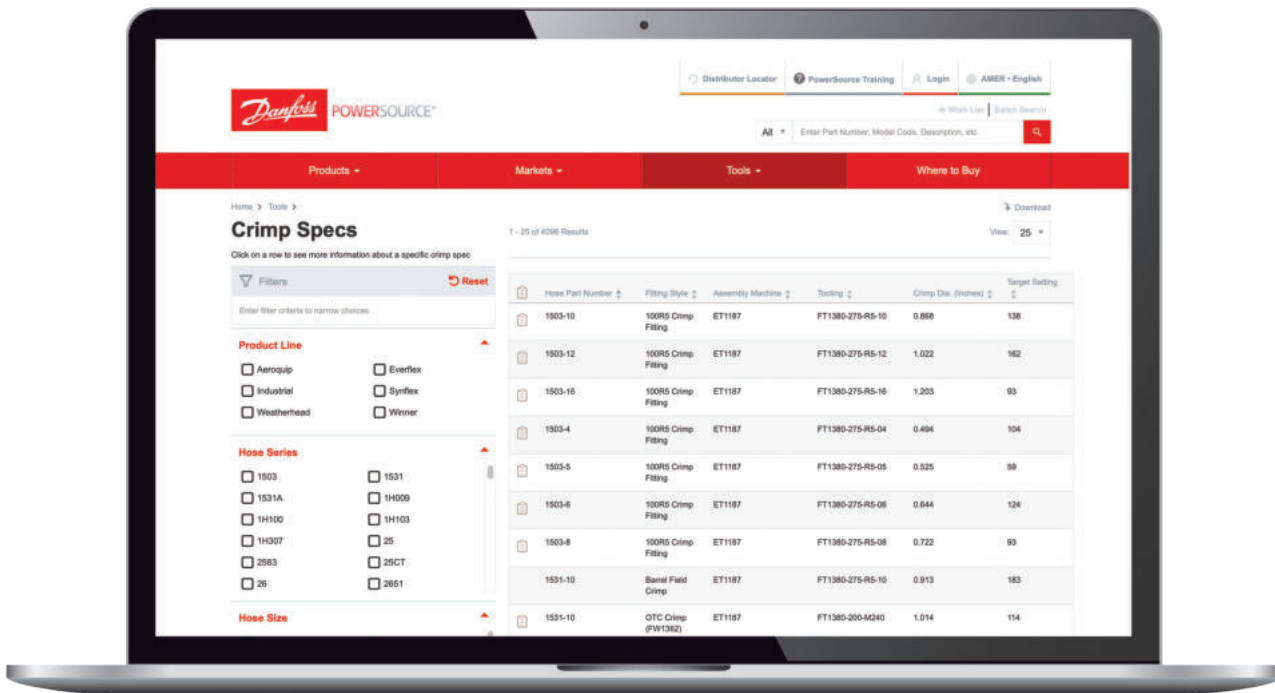

1. Go to PowerSource	2. Enter criteria	3. Download
<p>Visit Crimp Specs at <a href="http://danfoss.com/crimp">danfoss.com/crimp</a></p>	<p>Select your crimp spec criteria. This includes Assembly Machine(s), Product Line, Hose Series, Hose Size, and Fitting Style.</p>	<p>Locate the download icon at the top right of the screen and select either the PDF or Excel option to generate your custom chart.</p> <p>*Excel format allows you to perform custom sorting, filter data, remove unneeded fields, and to add custom notes and color coding.</p>

## Crimp specs

Danfoss's mobile crimp spec tool provides a four-step guided selection process for quick access to crimp specs on your mobile device.



Visit PowerSource Crimp specs at [power-source.com](#) on your mobile device

- Find your machine
- Select your hose series
- Select your hose size
- Find your fitting style

You can even bookmark the crimp spec page and add it as an app on the home screen of your mobile device for easy access at any time!

**For iOS,** open the webpage in Safari, click the boxed arrow icon at the bottom of the screen, and select the plus sign icon "Add to Home Screen."

**For Android,** open the webpage, click the three vertical dots on the top right hand corner, and select "Add to Home Screen."

Danfoss fluid conveyance training

Knowledge is power,

**Danfoss' Fluid Conveyance training**  
(virtual and face-to-face options available)

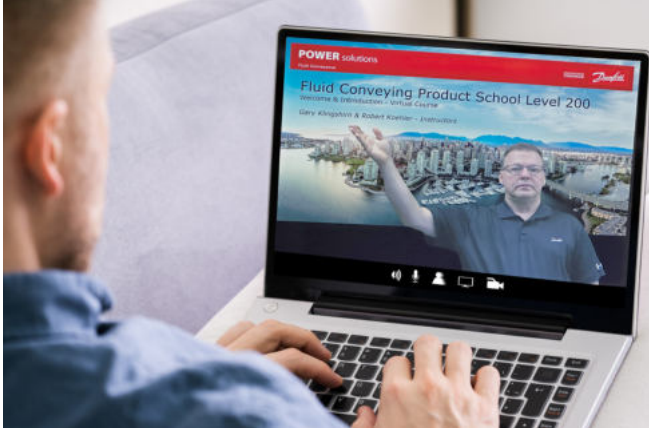

Virtual



Face-to-face

Master Danfoss's core fluid conveyance products and more with the help of our training team! Danfoss offers in depth, formal training courses designed to make you an expert in the field.

Attend Danfoss's 200 Level Fluid Conveying Products School to learn more about general product and application information or Danfoss' 300 and 400 Level Fluid Conveying Products Specialist School for a class focused on more technical information as well as competitive advantage materials.

Check out <https://www.danfoss.com/en-us/service-and-support/training/dps-learning-and-training-solutions/> for specific product courses and dates. If these locations and dates do not work for you, our experts can come to you. Contact [hydraulicstraining@Danfoss.com](mailto:hydraulicstraining@Danfoss.com) for further details.

Danfoss hydraulics training center  
1650 Indian Wood Circle  
Maumee, OH 43537  
Phone toll free: 1-800-413-8809  
Fax: (952) 906-3731

[Hydraulicstraining@Danfoss.com](mailto:Hydraulicstraining@Danfoss.com)



# asset tracker

## Small label. Big impact.

The Danfoss UniqID asset management solution seamlessly drives new efficiencies into every aspect of the asset lifecycle—from asset tracking, to routinized maintenance alerts, replacement orders and more. Through the use of an intuitive six-digit coding system and cloud-based portal—UniqID asset tracker makes it easy to label, track and replace hose assemblies.



To get started, contact [UniqID@Danfoss.com](mailto:UniqID@Danfoss.com) or visit [Danfoss.com/UniqID](http://Danfoss.com/UniqID)

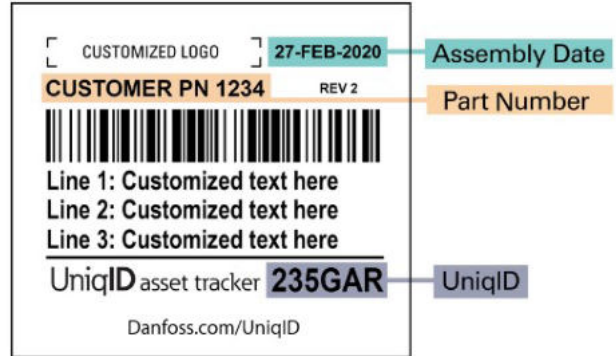

### Drive aftermarket sales

Via the UniqID code or label branding

### Grow your business

Offer services to set yourself apart from the competition

### Prevent attrition

Provide shared asset management information with key accounts



### Eliminate paper

With a web-based platform

### Proactive inspection and replacement

Cyclical approach to maintenance, increasing sales potential

### Improve decision making

With product lifecycle analysis tools

### Manage safety certification

With electronic attachment features



### Increase uptime

With proactive maintenance capabilities

### Reduce downtime

Order replacements without ever bringing in a hose assembly

### Reduce fines

By having critical documentation easy to find electronically



### Save time

UniqID's bill of material feature takes the guesswork out of hose replacement

### Reduce errors

Labels provide critical data at-a-glance

### Increase efficiency

Leverage shared attachments; no time wasted searching paper trails

Intelligent layline

Our laylines provide  
instantly.

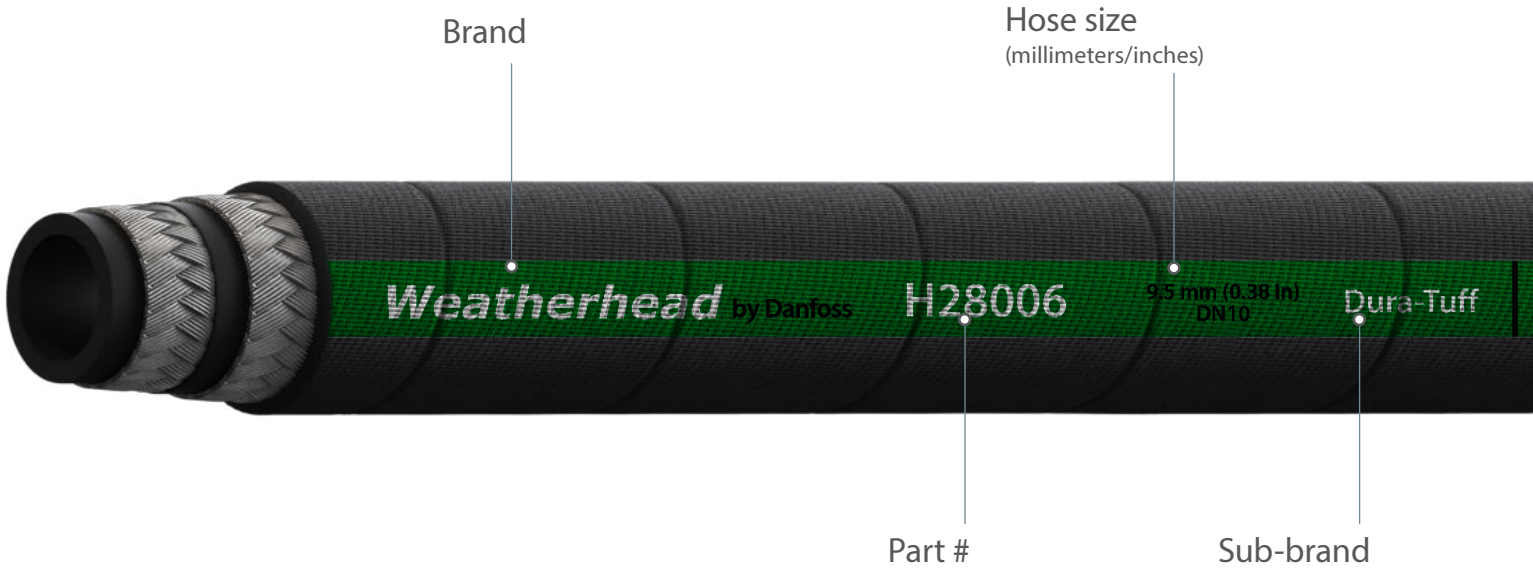

**\*Danfoss MatchMate® fitting system:**

Match fittings to hose with ease.

Braided hose:

**Z** on the layline should pair with a **Z** on the fitting part number.

One **O** on the layline will match with one ring on fitting designating **one-wire braided hose**.

Double **OO** on the layline will match with two rings on fitting designating **two-wire braided hose**.

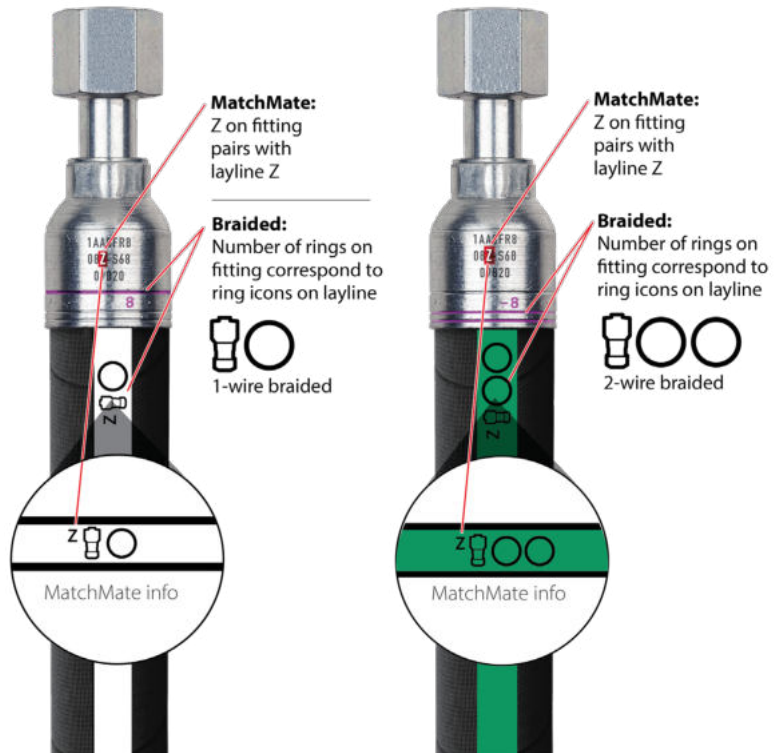

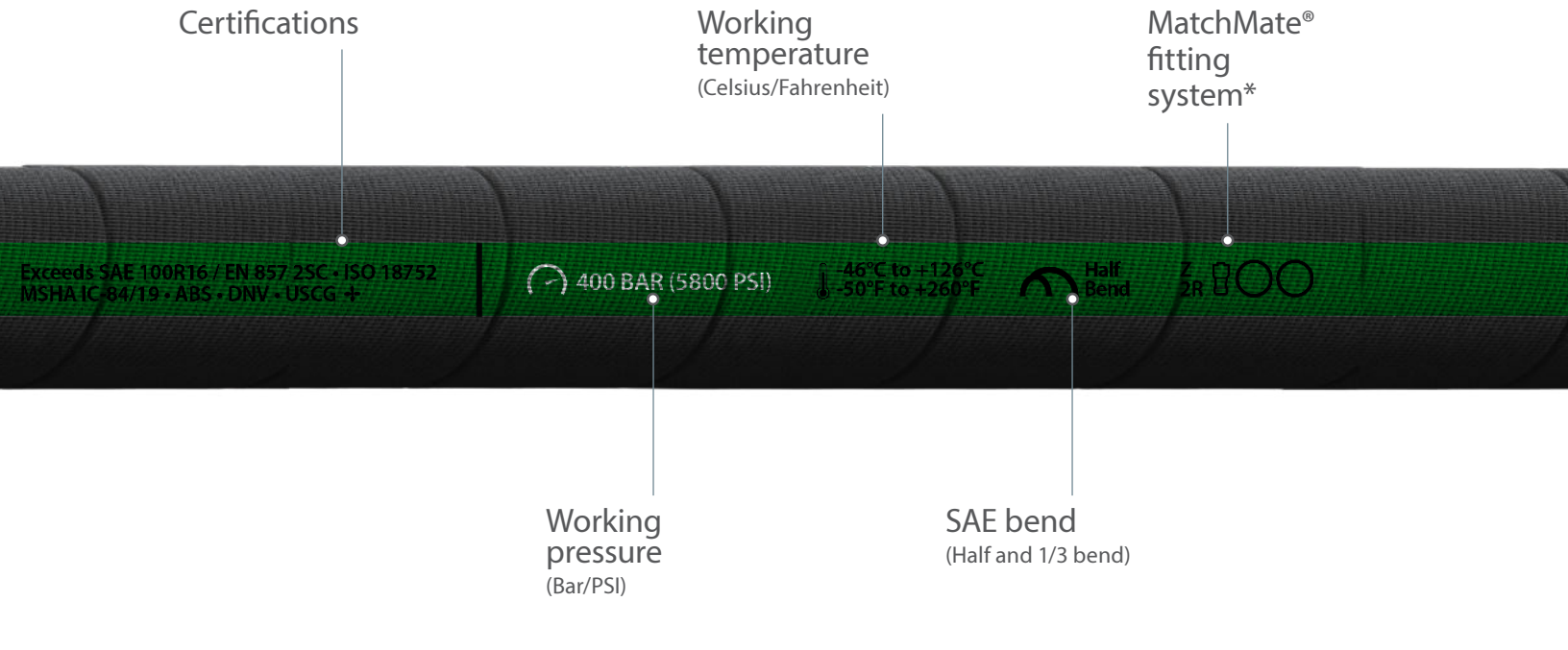

Spiral hose:

A **4S** or **6S** on the layline should pair with a **4S** or **6S** on the fitting part number.

A **4S** on layline should pair with **four rings on fitting** designating **four-wire spiral hose**.

A **6S** on layline will match with **six rings on fitting** designating **six-wire spiral hose**.





Two-tier product portfolio





From the ordinary to the extreme, Danfoss has a **solution that fits.**

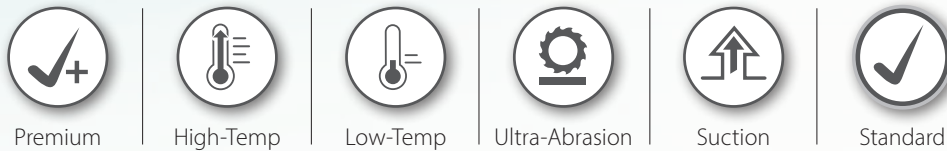

**Premium and standard hydraulic hose options:**

**Premium:** Weatherhead by Danfoss

**Standard:** Winner by Danfoss

At Danfoss, we understand that hydraulic hose and fittings need to match the application, for the ultimate performance and safety.

Because fluid conveyance platforms run the extreme, from low-pressure to high, moderate impulse to intense, from stable familiar environments to unforgiving conditions Danfoss Rubber Hydraulic Hose & Fittings provides options. The option to choose between standard-performance value based hose for less extreme environments and premium hoses developed for specific applications that push to the edge.









We do that for our customers, our partners. For those that put their trust in us. We don't compromise our standards and neither should you. When it comes to safety, technology and performance, we pledge our best, everyday.

**Note:** All core premium and standard hoses in the catalog are designated with an icon highlighting premium, premium specialty or standard. See chart on following page for more information.



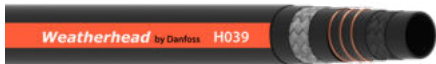

# Weatherhead

Two-tier product portfolio

The hoses	Operating temperature	Abrasion resistance	Bend radius	Impulse cycles
<b>PREMIUM</b> <span style="float: right;"><b>Certifications:</b> SAE ABS EN MSHA ISO DNV USCG</span>				
 <div style="text-align: center;">             Premium         </div>	<b>HIGH:</b> 260° F (127° C)  <b>LOW:</b> -40° F (-40° C)	<b>Dura-Tuff premium abrasion cover</b>	<b>1/2 Bend</b> (H881 is 1/3 bend)	<b>Exceed industry standard</b>
<b>HIGH-TEMP</b> <span style="float: right;"><b>Certifications:</b> SAE ABS EN MSHA ISO DNV USCG</span>				
 <div style="text-align: center;">             High-Temp         </div>	<b>HIGH:</b> 302° F (150° C)  <b>LOW:</b> -40° F (40° C)	<b>CPE high temp</b>	<b>Full Bend</b>	<b>Exceed industry standard</b>
<b>LOW-TEMP</b> <span style="float: right;"><b>Certifications:</b> SAE EN MSHA ISO</span>				
 <div style="text-align: center;">             Low-Temp         </div>	<b>HIGH:</b> 212° F (100° C)  <b>LOW:</b> -70° F (-57° C)	<b>Dura-Tuff premium abrasion cover</b>	<b>Full Bend</b>	<b>Exceed industry standard</b>
<b>ULTRA-ABRASION</b> <span style="float: right;"><b>Certifications:</b> SAE ABS EN MSHA ISO DNV</span>				
 <div style="text-align: center;">             Abrasion         </div>	<b>HIGH:</b> 212° F (100° C)  <b>LOW:</b> -40° F (40° C)	<b>Bruiser ultra-abrasion cover</b>	<b>Full Bend</b>	<b>Exceed industry standard</b>
<b>SUCTION</b> <span style="float: right;"><b>Certifications:</b> SAE ABS EN MSHA</span>				
 <div style="text-align: center;">             Suction         </div>	<b>HIGH:</b> 275° F (135° C)  <b>LOW:</b> -40° F (40° C)	<b>Standard cover</b>	<b>1/3 Bend</b>	<b>Exceed industry standard</b>

Two-tier product portfolio

The hoses	Operating temperature	Abrasion resistance	Bend radius	Impulse cycles
STANDARD	<b>Certifications:</b> SAE EN MSHA ISO DNV USCG			
  Standard	<b>HIGH:</b> 260° F (127° C)  <b>LOW:</b> -40° F (-40° C)	<b>Standard Cover</b>	<b>1/2 Bend</b> (excluding EC118)	<b>Meet industry standard</b>

## What are the

Danfoss' core rubber hydraulic portfolio is the heart of our product line. The core two-tier portfolio highlights the very best in technology and safety with hoses that are specifically designed to perform in a diverse range of applications, from the routine to the intense and all levels in-between.

### Core two-tier portfolio options



Premium



High-Temp



Low-Temp



Ultra-Abrasion



Suction



Standard

Our core premium hoses for OEM or aftermarket use exceed industry standards for pressure, temperature and abrasion resistance, with options adapted to handle your toughest jobs.

Winner® by Danfoss hoses meet all industry standards for pressure, temperature and abrasion resistance, offering the right product at a competitive price point for OEM markets.

#### Performance examples:

- Impulse life 150%\*
- 300K cycles
- 121° C
- High frequency flexing
- High pressure impulse

#### Performance examples:

- Impulse life 133%\*
- 200K cycles
- 100° C
- Normal frequency flexing
- Normal pressure impulse

\*compared to standard hose



page diagram

**6** Hose construction image



**1** Core hose key

✓+ Premium

**2** Part # and description

**H180** | Core premium one wire braided hose

Meets or exceeds:  
SAE 100R17 performance | EN 857 Type 1SC performance | ISO 1436 1SN | ISO 18752

**3** Hose part number & hose classification

Premium core hose  
H180

**4** Performance qualifications

**5** Layline

**Weatherhead** by Danfoss | **H18006** | 9,5 mm (0,38 in) DWT | **Dura-Tuff** | Exceeds EN 857 1SC Performance / SAE 100R17 - DNV ISO 1436 1SN - ISO 18752 - MSDHA G-8419 - ABS - USCG-4 | **235 BAR (3400 PSI)** | -46°C to +126°C / -50°F to +260°F | Half Braid | 

**7** Application and hose information

**Typical application:**  
Petroleum and fire-resistant hydraulic fluids, fuel and lubricating oils, gasoline, water and other industrial fluids

<b>Agency specifications:</b>				MSHA   ABS   DNV   USCG			
<b>Hose construction:</b>		<b>Inner Tube:</b> Nitrile	<b>Reinforcement:</b> One wire braid		<b>Cover:</b> Dura-Tuff Premium Abrasion		
<b>Operating temperature:</b>				-46°C to +126°C (-50°F to +260°F)			
<b>Qualified fittings:</b>				Z series 1R Series (-4, -6, -8, -12, -16)			

**8** Part # and hose specs

PART #	SIZE DIMENSIONS				PRESSURE				BEND		WEIGHT	
	Hose I.D.		Hose O.D. (nominal)		Working Pressure		Min. Burst Pressure		Min. Bend Radius		Weight	
	mm	in	mm	in	bar	psi	bar	psi	mm	in	kg/m	lbs/ft
<b>H18003</b>	4,8	0.19	10,9	0.42	250,0	3650	1000	14500	45,0	1.77	0,16	0.11
<b>H18004</b>	6,4	0.25	12,9	0.51	255,0	3700	1020	14800	50,0	1.97	0,21	0.14
<b>H18005</b>	7,9	0.31	14,0	0.55	225,0	3250	900	13000	55,0	2.17	0,22	0.15
<b>H18006</b>	9,5	0.38	16,3	0.64	235,0	3400	940	13600	63,0	2.48	0,31	0.21
<b>H18008</b>	12,7	0.50	19,9	0.78	221,0	3200	883	12800	90,0	3.54	0,43	0.29
<b>H18010</b>	15,9	0.63	22,3	0.88	140,0	2025	559	8100	100,0	3.94	0,44	0.29
<b>H18012</b>	19,0	0.75	26,0	1.02	138,0	2000	552	8000	120,0	4.72	0,56	0.37
<b>H18016</b>	25,4	1.00	34,0	1.34	103,0	1500	414	6000	150,0	5.91	0,84	0.56
<b>H18020</b>	31,8	1.25	41,5	1.63	69,0	1000	276	4000	210,0	8.27	1,01	0.68
<b>H18024</b>	38,1	1.50	47,9	1.89	52,0	750	207	3000	250,0	9.84	1,23	0.83
<b>H18032</b>	50,8	2.00	64,0	2.52	41,0	600	166	2400	315,0	12.4	2,01	1.32

**9** Hose classification

Core | Premium | Standard | Braided | Spiral | High-Temp | Low-Temp | Abrasion | Suction

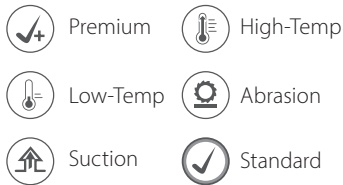
**1 Core hose key****2 Part # & description**

Hose part number and product description

**3 Hose part number and hose classification**

Corner key provides easy identification of hose name and premium, standard or core designation

**4 Performance qualifications**

Hose performance qualifications

- EN
- SAE
- ISO

**5 Intelligent layline**

Visual representation hose layline

**6 Hose construction**

Visual representation of hose construction

- One or two wire braid
- Four or six wire spiral
- Other

**7 Application & hose info**

Application info

- Agency specifications
  - MSHA
  - ABS
  - DNV
  - USCG
- Hose construction
  - Inner tube
  - Reinforcement
  - Cover
- Operating temperature
- Qualified fittings

**8 Part # and hose specs**

Quickly locate hose part number, sizing, pressure rating, bend radius and weight in an easy to read chart

- Hose Part #
- Size (mm, in):
  - Hose I.D.
  - Hose O.D.
- Pressure (Bar/PSI)
  - Working Pressure
  - Burst Pressure
- Hose bend (mm/in)
- Weight (kg/m | lbs./ft.)

**9 Easy hose classification**

Easy hose reference identification located at the bottom of all hose part pages

- Core
- Premium
- Standard
- Spiral
- High-temp
- Low-temp
- Abrasion
- Suction

# listings

**MSHA** US Mine Safety and Health Administration

**USCG** US Coast Guard

**DNV** DNV/GL (USA) WC

**DIN** Deutsche (German) Industrial Norme (Replaced by EN)

**EN** Committee for European Normalization

**ABS** American Bureau of Shipping

**SAE** Society of Automotive Engineers

**UL** Underwriters Laboratories

**ISO** International Standards Organization

ISO 18752 performance			
Type	Temperature	Impulse pressure % of max working pressure	Minimum # of cycles
<b>AC</b>	212° F (100° C)	133%	200,000
<b>BC</b>	212° F (100° C)	133%	500,000
<b>CC</b>	250° F (120° C)	133%	500,000
<b>DC</b>	250° F (120° C)	133%	1,000,000

EN hose series	
EN hose series	Description
<b>1ST</b>	One wire braid - standard cover
<b>1SN</b>	One wire braid - thin cover
<b>2ST</b>	Two wire braid - standard cover
<b>2SN</b>	Two wire braid - thin cover
<b>4SP</b>	Four wire spiral
<b>4SH</b>	High pressure four wire spiral
<b>1SC</b>	Compact one wire braid
<b>2SC</b>	Compact two wire braid

SAE 100R hose series	
SAE 100R series	Description
<b>100R1</b>	Steel wire reinforced, rubber covered hydraulic hose (one wire braid)
<b>100R2</b>	High pressure, steel wire reinforced, rubber covered hydraulic hose (two wire braid)
<b>100R3</b>	Double fiber braid (non-metallic), rubber covered hydraulic hose
<b>100R4</b>	Wire inserted hydraulic suction hose
<b>100R5</b>	Single wire braid, textile covered hydraulic hose
<b>100R6</b>	Single fiber braid (non-metallic), rubber covered hydraulic hose
<b>100R7</b>	Thermoplastic hydraulic hose Black - conductive Orange - non-conductive
<b>100R8</b>	High pressure thermoplastic hydraulic hose Black - conductive Orange - non-conductive
<b>100R9</b>	High pressure, four-spiral steel wire reinforced, rubber covered hydraulic hose
<b>100R10</b>	Heavy duty, four-spiral steel wire reinforced, rubber covered hydraulic hose

SAE 100R hose series	
SAE 100R series	Description
<b>100R11</b>	Heavy duty, six-spiral steel wire reinforced, rubber covered hydraulic
<b>100R12</b>	Heavy duty, high impulse, four-spiral wire reinforced, rubber covered hydraulic hose Heavy duty, high impulse, multiple-spiral wire reinforced, rubber covered hydraulic hose
<b>100R13</b>	Heavy duty, high impulse, multiple-spiral wire reinforced, rubber covered hydraulic hose
<b>100R14</b>	Polytetrafluorethylene (PTFE)-lined hydraulic hose, single-stainless steel braid
<b>100R15</b>	Heavy duty, high impulse, multiple-spiral wire reinforced, rubber
<b>100R16</b>	Compact high pressure, one- and two-wire reinforced rubber covered hydraulic hose
<b>100R17</b>	Compact 21 MPa maximum operating pressure, one- and two-steel wire reinforced rubber covered hydraulic hose with smaller bend radius
<b>100R19</b>	Compact 28 MPa maximum operating pressure, one- and two-steel wire reinforced rubber covered hydraulic hose with smaller bend radius



Premium



High-Temp



Low-Temp



Ultra-Abrasion















Suction



# The **premium** hoses

Core hose     

Hose	Page
<b>H180</b> Core premium one wire braided hose 	39
<b>H145R</b> Core premium Bruiser ultra-abrasion one & two wire braided hose 	40
<b>H190H</b> Core premium high temp one wire braided hose 	41
<b>H280</b> Core premium two wire braided hose 	42
<b>H881</b> Core premium Dynamax ultra- performance two wire braided hose 	43
<b>H290H</b> Core premium high-temp two wire braided hose 	44
<b>H245L</b> Core premium high-temp two wire braided hose 	45

Hose	Page
<b>H430</b> Core premium two wire braided hose 	46
<b>H430R</b> Core premium Bruiser ultra-abrasion four wire spiral hose 	47
<b>H525H</b> Core premium high-temp four wire spiral hose 	48
<b>H471</b> Core premium X-Flex four & six wire spiral hose 	49
<b>H810L</b> Core premium low-temp four & six wire spiral hose 	50
<b>H600</b> Core premium four & six wire spiral hose 	51

Hose	Page
<b>H190</b> Premium one wire braided hose	52
<b>H290</b> Premium two wire braided hose	53
<b>H145</b> Premium constant pressure one & two wire braided hose	54
<b>H545</b> Premium Bruiser constant pressure one & two wire braided hose	55

# The **premium** hoses

Core hose     

Hose Page

**H400** 56  
Premium 4000 PSI constant pressure  
two wire braided hose

**H421** 57  
Premium Hi-impulse jack  
two wire braided hose

Hose Page

**H850** 58  
Premium Dynamax ultra-performance  
four & six wire spiral hose

**H464** 59  
Premium four wire  
spiral hose

Hose Page

**H039** 60  
Premium  
suction hose 

**H039H** 61  
Premium high-temp  
suction hose

## Ordering information

### How to order

Accurate processing and prompt delivery of your order depends on easy identification of your requirements. Please order Weatherhead brand parts using correct part numbers as described in this guide. Inquiries and orders should be directed to your Weatherhead distributor or:

[www.Danfoss.com/hydraulics](http://www.Danfoss.com/hydraulics)

#### Part numbers and dash sizes

Dash size designates the nominal size in 16th of an inch. This number immediately follows the part number.

#### Dimensions

Dimensions given in this guide for Weatherhead products are approximate and should be used for reference only. Exact dimensional information for a given product is subject to change and varying tolerances; contact Danfoss directly for full current information.

### Number system - hydraulic hose

Most core hoses are offered on reels of 250 or 500 ft lengths:



Up to and including 12 inches:  $\pm 1/8"$

Above 12 inches to and including 18 inches:  $\pm 3/16"$

Above 18 inches to and including 36 inches:  $\pm 1/4"$

Above 36 inches:  $\pm 1\%$  of length

#### **WARNING** ⚠

##### **Hose assemblies**

Danfoss manufactures the terminal ends of our hose fittings to the appropriate requirements established by the SAE. Therefore, the performance ratings of these hose fittings meet the SAE requirements. It is possible to order a hose assembly with a fitting terminal end that has a performance rating lower than the hose rating. When ordering hose assemblies, please keep the connecting end performance rating in mind since this may affect overall hose assembly performance. Hose assembly components (hose and fittings) are easily assembled in the field. However, factory assembled reusable and crimped hose assemblies are available.

For complete information, contact Danfoss.





Premium

# H180

Core premium  
one wire braided hose

**Meets or exceeds:**

SAE 100R1 | SAE 100R17 | EN 857 Type 1SC performance | ISO 1436 1SN | ISO 18752

**Weatherhead** by Danfoss **H18006** 9.5 mm (0.38 in) DN10 **Dura-Tuff** Exceeds EN 857 1SC Performance / SAE 100R17 - DNV ISO 1436 1SN - ISO 18752 - MSHA IC-84/19 - ABS - USCG  $\curvearrowright$  **235 BAR (3400 PSI)**  $\begin{matrix} \uparrow -46^{\circ}\text{C to } +126^{\circ}\text{C} \\ \downarrow -50^{\circ}\text{F to } +260^{\circ}\text{F} \end{matrix}$

**Typical application:**

Petroleum and fire-resistant hydraulic fluids, fuel and lubricating oils, gasoline, water and other industrial fluids

<b>Agency specifications:</b>	ABS   DNV   MSHA   USCG		
<b>Hose construction:</b>	<b>Inner tube:</b> Nitrile	<b>Reinforcement:</b> One wire braid	<b>Cover:</b> Dura-Tuff premium abrasion
<b>Operating temperature:</b>	-46°C to +126°C (-50°F to +260°F)		
<b>Qualified fittings:</b>	Z series   1R series (-4, -6, -8, -12, -16)		

PART #	SIZE DIMENSIONS				PRESSURE				BEND		WEIGHT	
	Hose I.D.		Hose O.D. (nominal)		Working Pressure		Min. Burst Pressure		Min. Bend Radius		Weight	
	mm	in	mm	in	bar	psi	bar	psi	mm	in	kg/m	lbs/ft
<b>H18003</b>	4,8	0.19	10,9	0.42	250,0	3,650	1000	14,500	45,0	1.77	0,16	0.11
<b>H18004</b>	6,4	0.25	12,9	0.51	255,0	3,700	1020	14,800	50,0	1.97	0,21	0.14
<b>H18005</b>	7,9	0.31	14,0	0.55	225,0	3,250	900	13,000	55,0	2.17	0,22	0.15
<b>H18006</b>	9,5	0.38	16,3	0.64	235,0	3,400	940	13,600	63,0	2.48	0,31	0.21
<b>H18008</b>	12,7	0.50	19,9	0.78	221,0	3,200	883	12,800	90,0	3.54	0,43	0.29
<b>H18010</b>	15,9	0.63	22,3	0.88	140,0	2,025	559	8,100	100,0	3.94	0,44	0.29
<b>H18012</b>	19,0	0.75	26,0	1.02	138,0	2,000	552	8,000	120,0	4.72	0,56	0.37
<b>H18016</b>	25,4	1.00	34,0	1.34	103,0	1,500	414	6,000	150,0	5.91	0,84	0.56
<b>H18020</b>	31,8	1.25	41,5	1.63	69,0	1,000	276	4,000	210,0	8.27	1,01	0.68
<b>H18024</b>	38,1	1.50	47,9	1.89	52,0	750	207	3,000	250,0	9.84	1,23	0.83
<b>H18032</b>	50,8	2.00	64,0	2.52	41,0	600	166	2,400	315,0	12.4	2,01	1.32

Core | Premium | Standard | Braided | Spiral | High-Temp | Low-Temp | Abrasion | Suction

Premium core hose  
H145R

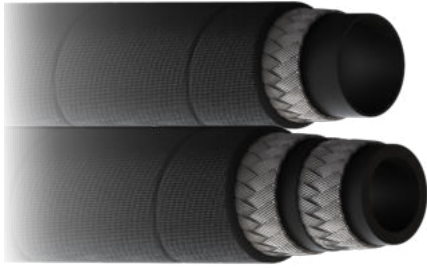

 Ultra-Abrasion

# H145R

Core premium Bruiser ultra-abrasion one & two wire braided hose

Meets or exceeds: SAE 100R17 | ISO 18752

**Weatherhead** by Danfoss **H145R06** 9.5 mm (0.38 in) DN10 Bruiser SAE 100R17 • ISO 18752 MSHA IC-84(71)  **210 BAR (3050 PSI)**  -40°C to +100°C -40°F to +212°F  z 

**Typical application:**

High abrasion industrial and hydraulic system applications with petroleum and water-based fluids

Recommended for use on critical applications in construction, forestry, and other off-highway vehicles. Bruiser™ outer cover offers unmatched abrasion, chemical, and environmental protection

<b>Agency specifications:</b>	MSHA		
<b>Hose construction:</b>	<b>Inner tube:</b> Nitrile	<b>Reinforcement:</b> One wire braid (-04 to -08) Two wire braid (-10 to -16)	<b>Cover:</b> Bruiser ultra-abrasion
<b>Operating temperature:</b>	-40°C to +100°C (-40°F to +212°F)		
<b>Qualified fittings:</b>	Z series		

PART #	SIZE DIMENSIONS				PRESSURE				BEND		WEIGHT	
	Hose I.D.		Hose O.D. (nominal)		Working Pressure		Min. Burst Pressure		Min. Bend Radius		Weight	
	mm	in	mm	in	bar	psi	bar	psi	mm	in	kg/m	lbs/ft
<b>H145R04</b>	6,4	0.25	12,7	0.50	210	3,050	840	12,200	50,0	1.97	0,22	0.15
<b>H145R06</b>	9,5	0.38	16,6	0.65	210	3,050	840	12,200	65,0	2.56	0,34	0.23
<b>H145R08</b>	12,7	0.50	20,9	0.82	210	3,050	840	12,200	90,0	3.54	0,48	0.32
<b>H145R10**</b>	15,9	0.62	24,9	0.98	210	3,050	840	12,200	100,0	3.94	0,71	0.48
<b>H145R12**</b>	19,0	0.75	28,5	1.12	210	3,050	840	12,200	120,0	4.72	0,89	0.60
<b>H145R16**</b>	25,4	1.00	37,1	1.46	210	3,050	840	12,200	150,0	5.91	1,43	0.96

\*\* two-wire braid hose

Core | Premium | Standard | Braided | Spiral | High-Temp | Low-Temp | Abrasion | Suction



High-Temp



# H190H

Core premium high-temp  
one wire braided hose

Meets: SAE 100R1 | EN 853

**Weatherhead** by Danfoss **H190H06** 9.5 mm (0.38 in) DN10 **High-Temp** Exceeds SAE 100R1 / EN 853 1.5N **215 BAR (3125 PSI)** -40°C to +150°C (-30°F to +302°F) Z

**Typical application:**

Petroleum and fire-resistant hydraulic fluids, fuel and lubricating oils, gasoline, water and other industrial fluids

<b>Agency specifications:</b>	ABS   MSHA		
<b>Hose construction:</b>	<b>Inner tube:</b> CPE	<b>Reinforcement:</b> One wire braid	<b>Cover:</b> CPE
<b>Operating temperature:</b>	-40°C to +150°C (-40°F to +302°F)		
<b>Qualified fittings:</b>	Z series		

PART #	SIZE DIMENSIONS				PRESSURE				BEND		WEIGHT	
	Hose I.D.		Hose O.D. (nominal)		Working Pressure		Min. Burst Pressure		Min. Bend Radius		Weight	
	mm	in	mm	in	bar	psi	bar	psi	mm	in	kg/m	lbs/ft
<b>H190H04</b>	6,4	0.25	13,5	0.53	225	3,250	900	13,000	100,0	3.94	0,25	0.17
<b>H190H06</b>	9,5	0.38	17,3	0.68	215	3,125	860	12,500	125,0	4.92	0,37	0.25
<b>H190H08</b>	12,7	0.50	20,4	0.80	175	2,550	700	10,200	180,0	7.09	0,45	0.30
<b>H190H10</b>	15,9	0.62	23,8	0.94	140	2,050	560	8,200	205,0	8.07	0,54	0.36
<b>H190H12</b>	19,0	0.75	27,4	1.08	125	1,800	500	7,200	240,0	9.45	0,69	0.46
<b>H190H16</b>	25,4	1.00	36,2	1.42	90	1,300	360	5,200	300,0	11.81	0,98	0.66
<b>H190H20</b>	31,8	1.25	43,9	1.73	65	950	260	3,800	420,0	16.54	1,26	0.85
<b>H190H24</b>	38,1	1.50	50,6	1.99	50	725	200	2,900	500,0	19.69	1,58	1.06
<b>H190H32</b>	50,8	2.00	59,2	2.33	40	580	160	2,320	630,0	24.80	2,04	1.37

Core | Premium | Standard | Braided | Spiral | **High-Temp** | Low-Temp | Abrasion | Suction

Premium core hose  
H280



Premium

# H280

Core premium  
two wire braided hose

Meets or exceeds: SAE 100R16 | EN 857 2SC | ISO 18752

**Weatherhead** by Danfoss **H28006** 9.5 mm (0.38 in) DN10 Dura-Tuff Exceeds SAE 100R16 / EN 857 2SC + ISO 18752 MSHA IC-84/19 • ABS • DNV • USCG+ 400 BAR (5800 PSI) -40°C to +126°C (-50°F to +260°F) Half Bend 2R

**Typical application:**

Hydraulic systems service with petroleum and water based fluids, for general use.

**Agency specifications:** ABS | DNV | MSHA | USCG

<b>Hose construction:</b>	<b>Inner tube:</b> Nitrile	<b>Reinforcement:</b> Two wire braid	<b>Cover:</b> Dura-Tuff premium abrasion
---------------------------	-------------------------------	---	--

**Operating temperature:** -46°C to +126°C (-50°F to +260°F)

**Qualified fittings:** Z series | 2R series

PART #	SIZE DIMENSIONS				PRESSURE				BEND		WEIGHT	
	Hose I.D.		Hose O.D. (nominal)		Working Pressure		Min. Burst Pressure		Min. Bend Radius		Weight	
	mm	in	mm	in	bar	psi	bar	psi	mm	in	kg/m	lbs/ft
<b>H28004</b>	6,4	0.25	13,9	0.55	448	6,500	1792	26,000	50,0	1.96	0,33	0.22
<b>H28006</b>	9,5	0.38	17,4	0.69	400	5,800	1600	23,200	65,0	2.55	0,43	0.29
<b>H28008</b>	12,7	0.50	20,9	0.82	345	5,000	1240	20,000	90,0	3.54	0,58	0.39
<b>H28010</b>	15,9	0.62	24,0	0.94	276	4,000	1104	16,000	100,0	3.94	0,65	0.44
<b>H28012</b>	19,0	0.75	27,9	1.10	241	3,500	964	14,000	120,0	4.72	0,79	0.53
<b>H28016</b>	25,4	1.00	35,9	1.41	207	3,000	828	12,000	150,0	5.90	1,07	0.72
<b>H28020</b>	31,8	1.25	43,4	1.71	172	2,500	688	10,000	210,0	8.26	1,62	1.09
<b>H28024</b>	38,1	1.50	51,5	2.03	138	2,000	552	8,000	250,0	9.84	2,08	1.40
<b>H28032</b>	50,8	2.00	63,9	2.52	110	1,600	440	6,400	315,0	12.40	2,83	1.90

Core | Premium | Standard | Braided | Spiral | High-Temp | Low-Temp | Abrasion | Suction



# H881

Core premium Dynamax ultra-performance two wire braided hose

Exceeds: SAE 100R16 | SAE 100R19 | EN 857 2SC | ISO 18752

**Weatherhead** by Danfoss **H88106** 9.5 mm(0.38 in) DN19 Dura-Tuff Dynamax Exceeds SAE 100R16 / 100R19 / EN857 2SC ISO 18752 • ABS • DNV-GL • MSHA IC 84/96 400 BAR (5800 PSI) -40°C to +120°C (-50°F to +260°F) 1/3 Bend Z series

**Typical application:**

Hydraulic systems with petroleum and water-based fluids, for general industrial service.

This Dynamax ultra-performance hose with the Danfoss Dura-Pulse inner tube combines the lightweight flexibility of a two-wire braided hose with the pressure and performance of spiral 100R12 hoses (-16 and smaller).

<b>Agency specifications:</b>	ABS   DNV   MSHA		
<b>Hose construction:</b>	<b>Inner tube:</b> Dura-Pulse patented tube	<b>Reinforcement:</b> Two wire braid	<b>Cover:</b> Dura-Tuff premium abrasion
<b>Operating temperature:</b>	-46°C to +126°C (-50°F to +260°F) -46° C to +70° C (-50 to +158° F) for water based hyd. fluids 0° C to +70° C (+32°F to 158° F) for water		
<b>Qualified fittings:</b>	Z series		

PART #	SIZE DIMENSIONS				PRESSURE				BEND		WEIGHT	
	Hose I.D.		Hose O.D. (nominal)		Working Pressure		Min. Burst pressure		Min. Bend Radius		Weight	
	mm	in	mm	in	bar	psi	bar	psi	mm	in	kg/m	lbs/ft
<b>H88104</b>	6,4	0.25	13,6	0.54	450	6,525	1800	26,100	33	1.30	0.32	0.22
<b>H88106</b>	9,5	0.38	17,3	0.68	400	5,800	1600	23,200	42	1.65	0.42	0.28
<b>H88108</b>	12,7	0.50	20,9	0.82	360	5,220	1440	20,880	60	2.36	0.58	0.39
<b>H88110</b>	15,9	0.62	24,0	0.94	350	5,075	1400	20,300	68	2.68	0.75	0.50
<b>H88112</b>	19,0	0.75	27,9	1.10	330	4,785	1320	19,140	80	3.15	1.03	0.69
<b>H88116</b>	25,4	1.00	34,6	1.36	280	4,060	1120	16,240	150	5.91	1.47	0.99
<b>H88120</b>	31,8	1.25	43,4	1.71	172	2,500	688	9,980	210	8.27	1.75	1.18
<b>H88124</b>	38,1	1.50	51,8	2.04	138	2,000	552	8,000	250	9.84	1.91	1.28

Core | Premium | Standard | Braided | Spiral | High-Temp | Low-Temp | Abrasion | Suction

Premium core hose  
H290H



 High-Temp

# H290H

Core premium high-temp  
two wire braided hose

Meets: SAE 100R2 | EN 853 2SN | ISO 1436

**Weatherhead** by Danfoss **H290H06** 9.5 mm (0.38 in) DN 16 High Temp Exceeds SAE 100R2 + EN 853 2SN ISO 1436-1 2SN **345 BAR (5000 PSI)** -40°C to +150°C / -40°F to +302°F z 

**Typical application:**

Petroleum and fire resistant hydraulic fluids, fuel, and lubricating systems

<b>Agency specifications:</b>	ABS   MSHA		
<b>Hose construction:</b>	<b>Inner tube:</b> CPE	<b>Reinforcement:</b> Two wire braid	<b>Cover:</b> CPE
<b>Operating temperature:</b>	-40°C to +150°C (-40°F to +302 °F)		
<b>Qualified fittings:</b>	Z series		

PART #	SIZE DIMENSIONS				PRESSURE				BEND		WEIGHT	
	Hose I.D.		Hose O.D. (nominal)		Working Pressure		Min. Burst Pressure		Min. Bend Radius		Weight	
	mm	in	mm	in	bar	psi	bar	psi	mm	in	kg/m	lbs/ft
<b>H290H04</b>	6,4	0.25	15,1	0.59	400,0	5,800	1600,0	23,200	102,0	4.02	0,40	0.27
<b>H290H06</b>	9.5	0.38	19,2	0.75	345,0	5,000	1380,0	20,000	127,0	5.00	0,58	0.39
<b>H290H08</b>	12,7	0.50	22,1	0.87	293,0	4,250	1172,0	17,000	178,0	7.01	0,68	0.46
<b>H290H10</b>	15.9	0.62	25,5	1.00	250,0	3,650	1000,0	14,600	203,0	7.99	0,80	0.54
<b>H290H12</b>	19,0	0.75	29,5	1.16	215,0	3,125	860,0	12,500	241,0	9.49	1,00	0.67
<b>H290H16</b>	25,4	1.00	37,8	1.49	175,0	2,550	700,0	10,200	305,0	12.01	1,44	0.97
<b>H290H20</b>	31,8	1.25	48,5	1.91	155,0	2,250	620,0	9,000	419,0	16.50	2,38	1.60
<b>H290H24</b>	38,1	1.50	55,1	2.17	125,0	1,800	500,0	7,250	508,0	20.00	2,59	1.74
<b>H290H32</b>	50,8	2.00	67,8	2.67	105,0	1,525	420,0	6,100	635,0	25.00	3,38	2.27

Core | Premium | Standard | Braided | Spiral | **High-Temp** | Low-Temp | Abrasion | Suction



Low-Temp



# H245L

Core premium low-temp  
two wire braided hose

Exceeds: SAE 100R16 | EN 857 2SC | ISO 11237-1

<b>Weatherhead</b> by Danfoss	<b>H245L06</b>	9.5 mm (0.38 in) DN10	Dura-Tuff Low-Temp	Exceeds SAE 100R16 / EN 857 2SC ISO 11237-1	345 BAR (5000 PSI)	-57°C to +100°C -70°F to +212°F	Z 00
-------------------------------	----------------	--------------------------	-----------------------	--	--------------------	------------------------------------	------

**Typical application:**

Low temperature flexing and hydraulic system service with petroleum and water-based fluids

For use in frigid environments on construction equipment and other mobile applications

<b>Agency specifications:</b>	MSHA		
<b>Hose construction:</b>	<b>Inner tube:</b> Proprietary low-temp	<b>Reinforcement:</b> Two wire braid	<b>Cover:</b> Dura-Tuff premium abrasion
<b>Operating temperature:</b>	-57°C to +100°C (-70°F to +212°F)		
<b>Qualified fittings:</b>	Z series		

PART #	SIZE DIMENSIONS				PRESSURE				BEND		WEIGHT	
	Hose I.D.		Hose O.D. (nominal)		Working Pressure		Min. Burst Pressure		Min. Bend Radius		Weight	
	mm	in	mm	in	bar	psi	bar	psi	mm	in	kg/m	lbs/ft
<b>H245L04</b>	6,4	0.25	13,8	0.54	414,0	6,000	1656,0	24,025	51,0	2.00	0,30	0.20
<b>H245L06</b>	9,5	0.38	17,4	0.68	345,0	5,000	1380,0	20,025	64,0	2.50	0,40	0.27
<b>H245L08</b>	12,7	0.50	20,8	0.82	310,0	4,500	1240,0	18,000	89,0	3.50	0,58	0.39
<b>H245L10</b>	15,9	0.62	24,9	0.98	276,0	4,000	1104,0	16,000	102,0	4.00	0,74	0.50
<b>H245L12</b>	19,0	0.75	28,4	1.12	241,0	3,500	964,0	14,000	121,0	4.75	0,92	0.62
<b>H245L16</b>	25,4	1.00	35,7	1.41	193,0	2,800	772,0	11,200	152,0	6.00	1,22	0.82
<b>H245L20</b>	31,8	1.25	43,3	1.71	159,0	2,300	636,0	9,225	210,0	8.25	1,59	1.07
<b>H245L24</b>	38,1	1.50	51,5	2.03	138,0	2,000	552,0	8,000	254,0	10.00	2,11	1.42
<b>H245L32</b>	50,8	2.00	63,9	2.51	103,0	1,500	412,0	6,000	318,0	12.50	2,80	1.88

Core | Premium | Standard | Braided | Spiral | High-Temp | **Low-Temp** | Abrasion | Suction



Premium core hose  
H430



Premium

# H430

Core premium  
four wire spiral hose

Exceeds: SAE 100R12 | EN 856 R12 | ISO 18752

**Weatherhead** by Danfoss **H43006** 9.5 mm (0.38 in) DN10 Dura-Tuff Exceeds SAE 100R12 / EN 856 R12 MSHA IC-84/19 - ABS - DNV - USCG+ 448 BAR (6500 PSI) -40°C to +126°C -40°F to +260°F Half Bend 4S

**Typical application:**

For very high pressure hydraulic lines subjected to pressure surges and flexing

Typical applications include construction, mining, farming and high performance industrial equipment

<b>Agency specifications:</b>	ABS   DNV   MSHA   USCG		
<b>Hose construction:</b>	<b>Inner tube:</b> Nitrile	<b>Reinforcement:</b> Four wire spiral	<b>Cover:</b> Dura-Tuff premium abrasion
<b>Operating temperature:</b>	-40°C to +126°C (-40°F to +260°F)		
<b>Qualified fittings:</b>	4S series		

PART #	SIZE DIMENSIONS				PRESSURE				BEND		WEIGHT	
	Hose I.D.		Hose O.D. (nominal)		Working Pressure		Min. Burst Pressure		Min. Bend Radius		Weight	
	mm	in	mm	in	bar	psi	bar	psi	mm	in	kg/m	lbs/ft
<b>H43006</b>	9,5	0.38	20,2	0.80	448,0	6,500	1792,0	26,000	62,5	2.46	0,71	0.47
<b>H43008</b>	12,7	0.50	23,6	0.93	415,0	6,000	1660,0	24,000	90,0	3.54	0,88	0.59
<b>H43010</b>	15,9	0.62	27,4	1.08	415,0	6,000	1660,0	24,000	100,0	3.94	1,04	0.70
<b>H43012</b>	19,0	0.75	30,7	1.21	380,0	5,500	1520,0	22,000	120,0	4.72	1,34	0.90
<b>H43016</b>	25,4	1.00	37,9	1.49	350,0	5,100	1400,0	20,400	150,0	5.91	1,79	1.20
<b>H43020</b>	31,8	1.25	46,6	1.83	310,0	4,500	1240,0	18,000	210,0	8.27	2,23	1.50
<b>H43024</b>	38,1	1.50	53,9	2.12	275,0	4,000	1100,0	16,000	250,0	9.84	3,03	2.03
<b>H43032</b>	50,8	2.00	66,8	2.63	275,0	4,000	1100,0	16,000	320,0	12.60	4,38	2.94

Core | Premium | Standard | Braided | **Spiral** | High-Temp | Low-Temp | Abrasion | Suction



 Ultra-Abrasion

# H430R

Core premium Bruiser ultra-abrasion four wire spiral hose

Exceeds: SAE 100R12 | EN 856 R12 | ISO 18752

**Weatherhead** by Danfoss **H430R06** 9.5 mm (0.38 in) DN10 **Bruiser** SAE 100R12 / EN 856 R12 ISO 18752 • MSHA IC-84/71 **280 BAR (405 0 PSI)**  -40°C to +121°C -40°F to +250°F **4S**

**Typical application:**

High abrasion industrial and hydraulic system applications with petroleum and water-based fluids

Recommended for critical applications in construction, forestry, and other off-highway vehicles

Bruiser ultra-abrasion outer cover offers unmatched abrasion, chemical and environmental protection

<b>Agency specifications:</b>	MSHA		
<b>Hose construction:</b>	<b>Inner tube:</b> Nitrile	<b>Reinforcement:</b> Four wire spiral	<b>Cover:</b> Bruiser ultra-abrasion
<b>Operating temperature:</b>	-40°C to +121°C (-40°F to +250°F)		
<b>Qualified fittings:</b>	4S series		

PART #	SIZE DIMENSIONS				PRESSURE				BEND		WEIGHT	
	Hose I.D.		Hose O.D. (nominal)		Working Pressure		Min. Burst Pressure		Min. Bend Radius		Weight	
	mm	in	mm	in	bar	psi	bar	psi	mm	in	kg/m	lbs/ft
<b>H43006</b>	9,5	0.38	20,2	0.80	380	5,500	1520	22,000	125	4.92	0,71	0.48
<b>H43008</b>	12,7	0.50	23,6	0.93	345	5,000	1380	20,000	180	7.09	0,83	0.56
<b>H43010</b>	15,9	0.62	27,4	1.08	345	5,000	1380	20,000	200	7.87	0,98	0.66
<b>H43012</b>	19,0	0.75	30,7	1.21	280	4,050	1120	16,200	240	9.45	1,32	0.89
<b>H43016</b>	25,4	1.00	37,9	1.49	280	4,050	1120	16,200	300	11.81	1,75	1.18
<b>H43020</b>	31,8	1.25	46,6	1.83	210	3,050	840	12,200	420	16.54	2,36	1.59
<b>H43024</b>	38,1	1.50	53,9	2.12	175	2,550	700	10,200	500	19.68	3,00	2.01
<b>H43032</b>	50,8	2.00	66,8	2.63	175	2,550	700	10,200	640	25.2	4,37	2.94

Core | Premium | Standard | Braided | **Spiral** | High-Temp | Low-Temp | Abrasion | Suction

Premium core hose  
H525H

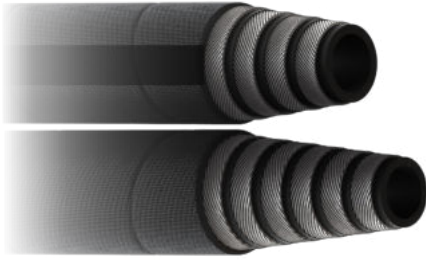

 High-Temp

# H525H

Core premium AQP™ high-temp  
four & six wire spiral hose

**Weatherhead** by Danfoss **H525H12** 19 mm (0.75 in) DN19 High Temp MSHA IC-84/18 345 BAR (5000 PSI) -40°C to +149°C -40°F to +300°F 4S

**Typical application:**

Hydraulic system service with petroleum, fire-resistant, and water-based fluids, fuel, and lubricating systems

<b>Agency specifications:</b>	MSHA		
<b>Hose construction:</b>	<b>Inner tube:</b> CPE	<b>Reinforcement:</b> Four wire spiral (-12 to -24) Six wire spiral (-32)	<b>Cover:</b> CPE
<b>Operating temperature:</b>	Typical fluids: -40°C To +149°C (-40°F To +300°F) Phosphate-ester base fluids: -40°C To +82°C (-40°F To +180°F)		
<b>Qualified fittings:</b>	4S series		

PART #	SIZE DIMENSIONS				PRESSURE				BEND		WEIGHT	
	Hose I.D.		Hose O.D. (nominal)		Working Pressure		Min. Burst Pressure		Min. Bend Radius		Weight	
	mm	in	mm	in	bar	psi	bar	psi	mm	in	kg/m	lbs/ft
<b>H525H12</b>	19,0	0.75	30,7	1.21	345,0	5,000	1380,0	20,000	241,3	9.50	1,28	0.86
<b>H525H16</b>	25,4	1.00	37,9	1.49	345,0	5,000	1380,0	20,000	304,8	12.00	1,73	1.16
<b>H525H20</b>	31,8	1.25	46,6	1.84	240,0	3,500	960,0	14,000	419,1	16.50	2,31	1.55
<b>H525H24</b>	38,1	1.50	53,9	2.12	240,0	3,500	960,0	14,000	508,0	20.00	2,96	1.99
<b>H525H32</b>	50,8	2.00	67,3	2.65	225,0	3,250	900,0	13,000	635,0	25.00	4,42	2.97

Core | Premium | Standard | Braided | **Spiral** | **High-Temp** | Low-Temp | Abrasion | Suction

Premium core hose  
H471



**H471** | Core premium X-Flex  
four & six wire spiral hose

Exceeds: SAE 100R13 | EN 856 R13 | ISO 3862 R13

**Weatherhead** by Danfoss **H47116** 25.4 mm (1.00 in) DN25 **Dura-Tuff X-Flex** Exceeds EN 856 R13 / SAE 100R13 ISO 3862 R13 - MSHA IC-84/19 - USCG **350 BAR (5100 PSI)** -40°C to +127°C / -40°F to +260°F **4S**

**Typical application:**

Ultra high pressure applications compatible with petroleum and water-based fluids

**Agency specifications:** MSHA | USCG

<b>Hose construction:</b>	<b>Inner tube:</b> Nitrile	<b>Reinforcement:</b> Four wire spiral (-12 to -24) Six wire spiral (-32)	<b>Cover:</b> Dura-Tuff premium abrasion
---------------------------	-------------------------------	---	---

**Operating temperature:** -40°C to +127°C (-40°F to +260°F)

**Qualified fittings:** 4S series (-12 to -24) | 6S series (-32)

PART #	SIZE DIMENSIONS				PRESSURE				BEND		WEIGHT	
	Hose I.D.		Hose O.D. (nominal)		Working Pressure		Min. Burst Pressure		Min. Bend Radius		Weight	
	mm	in	mm	in	bar	psi	bar	psi	mm	in	kg/m	lbs/ft
<b>H47112</b>	19,0	0.75	31,0	1.22	350,0	5,100	1400,0	20,400	121,0	4.75	1,28	0.86
<b>H47116</b>	25,4	1.00	38,4	1.51	350,0	5,100	1400,0	20,400	152,0	6.00	1,85	1.24
<b>H47120</b>	31,8	1.25	45,5	1.79	350,0	5,100	1400,0	20,400	210,0	8.25	2,50	1.68
<b>H47124</b>	38,1	1.50	53,5	2.11	350,0	5,100	1400,0	20,400	254,0	10.00	3,38	2.27
<b>H47132**</b>	50,8	2.00	71,8	2.83	350,0	5,100	1400,0	20,400	476,0	18.75	6,07	4.08

\*\* Six wire spiral

Premium core hose  
H810L

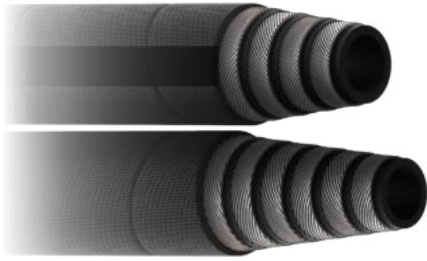

# H810L

Core premium low-temp  
four & six wire spiral hose

**Exceeds:** SAE 100R15 | EN 856 4SH Performance

<b>Weatherhead</b> by Danfoss	<b>H810L12</b>	19.0 mm (0.75 in) DN19	Low-Temp	MSHA IC-84/19	420 BAR (6100 PSI)	-57°C to +100°C -70°F to +212°F	4S
-------------------------------	----------------	---------------------------	----------	---------------	--------------------	------------------------------------	----

**Typical application:**

Fluids for low temperature applications.  
Hydraulic systems with petroleum-based fluids

<b>Agency specifications:</b>	MSHA		
<b>Hose construction:</b>	<b>Inner tube:</b> Exclusive low-temp tube	<b>Reinforcement:</b> Four wire spiral (-12 to -16) Six wire spiral (-20 to -32)	<b>Cover:</b> Nitrile
<b>Operating temperature:</b>	-57°C to +100°C (-70°F to +212°F)		
<b>Qualified fittings:</b>	4S series (-12 to -16)   6S series (-20 to -32)		

PART #	SIZE DIMENSIONS				PRESSURE				BEND		WEIGHT	
	Hose I.D.		Hose O.D. (nominal)		Working Pressure		Min. Burst Pressure		Min. Bend Radius		Weight	
	mm	in	mm	in	bar	psi	bar	psi	mm	in	kg/m	lbs/ft
<b>H810L12</b>	19,0	0.75	32,2	1.27	420	6,100	1,680	24,360	280,0	11.02	1,61	1.08
<b>H810L16</b>	25,4	1.00	39,0	1.54	420	6,100	1,680	24,360	340,0	13.39	2,02	1.36
<b>H810L20**</b>	31,8	1.25	49,4	1.94	420	6,100	1,680	24,360	420,0	16.54	3,55	2.39
<b>H810L24**</b>	38,1	1.50	57,3	2.26	420	6,100	1,680	24,360	510,0	20.08	4,74	3.19
<b>H810L32**</b>	50,8	2.00	71,7	2.82	350	5,100	1,400	20,400	630,0	24.80	6,70	4.50

\*\*Six wire spiral

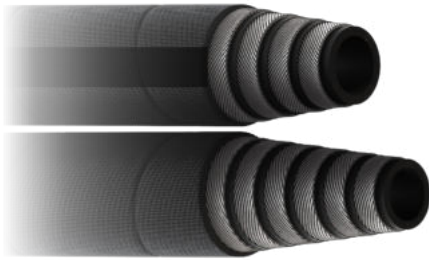

**H600** | Core premium X-Flex  
four & six wire spiral hose

Meets or exceeds: SAE 100R15 | EN 856 4SH | EN 856 R13 | ISO 18752

**Weatherhead** by Danfoss **H60012** 19.0 MM (0.75 IN) DN19 **Dura-Tuff X-Flex** Exceeds SAE 100R15 • ISO 18752 MSHA IC-84/19 • ABS • DNV • USCG+ 420 BAR (6100 PSI) -40°C to +127°C -40°F to +260°F Half Bend 1W 4S

**Typical application:**

High pressure hydraulic circuits on mobile construction equipment, mining equipment, and industrial applications for pressures up to 420 bar.

**Agency specifications:** ABS | DNV | MSHA | USCG

<b>Hose construction:</b>	<b>Inner tube:</b> Dura-Pulse patented inner tube	<b>Reinforcement:</b> Four wire spiral (-12 to -16) Six wire spiral (-20 to -32)	<b>Cover:</b> Dura-Tuff premium abrasion
---------------------------	--	--	---

**Operating temperature:** -40°C to +127°C (-40°F to +260°F)

**Qualified fittings:** 4S series (-12 to -16) | 6S series (-20 to -32) | 1W series

PART #	SIZE DIMENSIONS				PRESSURE				BEND		WEIGHT	
	Hose I.D.		Hose O.D. (nominal)		Working Pressure		Min. Burst Pressure		Min. Bend Radius		Weight	
	mm	in	mm	in	bar	psi	bar	psi	mm	in	kg/m	lbs/ft
<b>H60012</b>	19,0	0.75	32,2	1.27	420	6,100	1,680	24,400	135	5.31	1.52	1.01
<b>H60016</b>	25,4	1.00	38,6	1.52	420	6,100	1,680	24,400	165	6.5	2.04	1.36
<b>H60020**</b>	31,8	1.25	49,7	1.96	420	6,100	1,680	24,400	225	8.86	3.89	2.61
<b>H60024**</b>	38,1	1.50	57,5	2.26	420	6,100	1,680	24,400	265	10.43	4.83	3.24
<b>H60032**</b>	50,8	2.00	71,0	2.79	420	6,100	1,680	24,400	375	14.76	7.1	4.77

\*\*Six wire spiral

Premium hose  
H190



# H190

Premium  
one wire braided hose

**Exceeds:** SAE 100R1 | EN 853 1SN performance | ISO 1436-1SN

**Weatherhead** by Danfoss **H19006** 9.5 mm (0.38 in) DN10 Dura-Tuff Exceeds SAE 100R1 / ISO 1436 • MSHA IC-84/19 Exceeds EN 853 1SN Performance • ABS • USCG 235 BAR (3400 PSI) -40°C to +126°C -50°F to +260°F Half Bend Z

**Typical application:**

Hydraulic system service with petroleum and water-based fluids, for general industrial service

<b>Agency specifications:</b>	ABS   MSHA   USCG		
<b>Hose construction:</b>	<b>Inner tube:</b> Nitrile	<b>Reinforcement:</b> One wire braid	<b>Cover:</b> Dura-Tuff premium abrasion
<b>Operating temperature:</b>	-46°C to +126°C (-50°F to +260°F)		
<b>Qualified fittings:</b>	Z series		

PART #	SIZE DIMENSIONS				PRESSURE				BEND		WEIGHT	
	Hose I.D.		Hose O.D. (nominal)		Working Pressure		Min. Burst Pressure		Min. Bend Radius		Weight	
	mm	in	mm	in	bar	psi	bar	psi	mm	in	kg/m	lbs/ft
<b>H19004</b>	6,4	0.25	13,5	0.53	255	3,700	1,020	14,800	101,6	4.00	7,3	16
<b>H19006</b>	9,5	0.38	17,5	0.69	235	3,400	940	13,600	127,0	5.00	11,4	25
<b>H19008</b>	12,7	0.50	20,6	0.81	200	2,900	800	11,600	177,8	7.00	13,6	30
<b>H19010</b>	15,9	0.63	23,8	0.94	130	1,885	520	7,540	203,2	8.00	15,9	35
<b>H19012</b>	19,0	0.75	27,8	1.09	138	2,000	552	8,000	241,3	9.50	20,5	45
<b>H19016</b>	25,4	1.00	35,7	1.41	103	1,500	412	6,000	304,8	12.00	30,9	68
<b>H19020</b>	31,8	1.25	43,4	1.71	69	1,000	276	4,000	419,1	16.50	40,9	88
<b>H19024</b>	38,1	1.50	50,6	1.99	52	750	208	3,000	508,0	20.00	47,7	105
<b>H19032</b>	50,8	2.00	64,0	2.52	41	600	164	2,400	635,0	25.00	59,5	131

Core | **Premium** | Standard | Braided | Spiral | High-Temp | Low-Temp | Abrasion | Suction





# H290

Premium  
two wire braided hose

Exceeds: SAE 100R2 | EN 853 2SN Performance | ISO 1436 2SN

**Weatherhead** by Danfoss **H29004** 6.4 mm (0.25 in) DN6 Dura-Tuff Exceeds SAE 100R2 / ISO 1436 2SN • MSHA IC-84/56 Exceeds EN 853 2SN Performance • USCG **448 BAR (6500 PSI)** -40°C to +126°C (-40°F to +260°F) Z R

**Typical application:**

Hydraulic system service with petroleum and water-based fluids, for general industrial service

**Agency specifications:** MSHA | USCG

<b>Hose construction:</b>	<b>Inner tube:</b> Nitrile	<b>Reinforcement:</b> Two wire braid	<b>Cover:</b> Dura-Tuff premium abrasion
---------------------------	-------------------------------	---	--

**Operating temperature:** -40°C to +126°C (-40°F to +260°F)

**Qualified fittings:** Z series | 2R series

PART #	SIZE DIMENSIONS				PRESSURE				BEND		WEIGHT	
	Hose I.D.		Hose O.D. (nominal)		Working Pressure		Min. Burst Pressure		Min. Bend Radius		Weight	
	mm	in	mm	in	bar	psi	bar	psi	mm	in	kg/m	lbs/ft
<b>H29004</b>	6,4	0.25	15,1	0.59	448	6,500	1792	26,000	101,6	4.00	11,8	26
<b>H29006</b>	9,5	0.38	19,0	0.75	400	5,800	1600	23,200	127,0	5.00	17,3	38
<b>H29008</b>	12,7	0.50	22,2	0.88	345	5,000	1380	20,000	177,8	7.00	20,1	46
<b>H29010</b>	15,9	0.63	25,4	1.00	276	4000	1104	16,000	203,2	8.00	24,5	54
<b>H29012</b>	19,0	0.75	29,4	1.16	241	3,500	964	14,000	241,3	9.50	30,0	66
<b>H29016</b>	25,4	1.00	38,1	1.50	207	3,000	828	12,000	304,8	12.00	45,9	101
<b>H29020</b>	31,8	1.25	48,8	1.92	172	2,500	688	10,000	419,1	16.50	70,0	154
<b>H29024</b>	38,1	1.50	54,6	2.15	138	2,000	552	8,000	508,0	20.00	76,4	168
<b>H29032</b>	50,8	2.00	63,8	2.51	110	1,600	440	6,400	635,0	25.00	100,9	222

Core | **Premium** | Standard | Braided | Spiral | High-Temp | Low-Temp | Abrasion | Suction

Premium hose  
H145



# H145

Premium two wire braided hose

**Exceeds:** SAE 100R2 | SAE 100R17 | EN 853 2SN Performance | ISO 1436 2SN (-12, -16)

**Weatherhead** by Danfoss **H14504** 6.4 mm (0.25 in) DN6 Constant Pressure SAE 10017 USCG 210 BAR (3050 PSI) -40°C to +121°C / -40°F to +250°F

**Typical application:**

Hydraulic system service with petroleum and water-based fluids, for general industrial service

<b>Agency specifications:</b>	MSHA   USCG		
<b>Hose construction:</b>	<b>Inner tube:</b> Nitrile	<b>Reinforcement:</b> Two wire braid	<b>Cover:</b> Dura-Tuff premium abrasion
<b>Operating temperature:</b>	-40°C to +126°C (-40°F to +260°F)		
<b>Qualified fittings:</b>	Z series   2R series		

PART #	SIZE DIMENSIONS				PRESSURE				BEND		WEIGHT	
	Hose I.D.		Hose O.D. (nominal)		Working Pressure		Min. Burst Pressure		Min. Bend Radius		Weight	
	mm	in	mm	in	bar	psi	bar	psi	mm	in	kg/m	lbs/ft
<b>H14504</b>	6,4	0.25	12,7	0.50	210,0	3,045	840,0	12,180	38,1	2.00	6,8	15
<b>H14506</b>	9,5	0.38	16,3	0.64	210,0	3,045	840,0	12,180	50,8	2.50	10,5	23
<b>H14508</b>	12,7	0.50	20,6	0.81	210,0	3,045	840,0	12,180	58,7	3.50	14,5	32
<b>H14510</b>	15,9	0.63	24,6	0.97	210,0	3,045	840,0	12,180	69,9	4.00	23,2	51
<b>H14512</b>	19,0	0.75	29,4	1.16	210,0	3,045	840,0	12,180	82,6	4.75	28,6	63
<b>H14516</b>	25,4	1.00	37,3	1.47	210,0	3,045	840,0	12,180	101,6	6.00	41,4	91



# H545

Premium 4000 PSI constant pressure  
two wire braided hose

**Weatherhead** by Danfoss | **H54506** | 9.5 mm (0.38 in) DN10 | **Bruiser** | **207 BAR (3000 PSI)** | -40°C to +121°C / -40°F to +250°F | z

**Typical application:**

Industrial and hydraulic system applications with petroleum and water-based fluids

Recommended for use on construction, forestry, and other off-highway vehicles

**Agency specifications:**

<b>Hose construction:</b>	<b>Inner tube:</b> Nitrile	<b>Reinforcement:</b> Two wire braid	<b>Cover:</b> Dura-Tuff premium abrasion
---------------------------	-------------------------------	---	---

**Operating temperature:** -40°C to +100°C (-40°F to +212°F)

**Qualified fittings:** Z series

PART #	SIZE DIMENSIONS				PRESSURE				BEND		WEIGHT	
	Hose I.D.		Hose O.D. (nominal)		Working Pressure		Min. Burst Pressure		Min. Bend Radius		Weight	
	mm	in	mm	in	bar	psi	bar	psi	mm	in	kg/m	lbs/ft
<b>H54504</b>	6,4	0.25	13,5	0.53	206,9	3,000	827,4	12,000	50,8	2.00	6,4	14
<b>H54506</b>	9,5	0.38	15,9	0.63	206,9	3,000	827,4	12,000	63,5	2.50	8,2	18
<b>H54508</b>	12,7	0.50	20,6	0.81	206,9	3,000	827,4	12,000	88,9	3.50	14,5	32
<b>H54510</b>	15,9	0.63	23,8	0.94	206,9	3,000	827,4	12,000	101,6	4.00	16,8	37
<b>H54512</b>	19,0	0.75	28,6	1.13	206,9	3,000	827,4	12,000	120,7	4.75	24,4	54
<b>H54516</b>	25,4	1.00	35,7	1.41	206,9	3,000	827,4	12,000	152,4	6.00	39,0	86

Premium hose  
H400



**H400** | Premium 4000 PSI constant pressure two wire braided hose

**Exceeds:** SAE 100R19 Performance

**Weatherhead** by Danfoss **H40006** 9.5 mm (0.38 in) DN10 **Dura-Tuff** Exceeds SAE 100R19 Performance MSHA IC-84/19 **275 BAR (4000 PSI)** -40°C to +100°C / -40°F to +212°F z

**Typical application:**

Industrial and hydraulic system applications with petroleum and water-based fluids

Recommended for use on construction, forestry, and other off-highway vehicles

<b>Agency specifications:</b>	MSHA		
<b>Hose construction:</b>	<b>Inner tube:</b> Nitrile	<b>Reinforcement:</b> Two wire braid	<b>Cover:</b> Dura-Tuff premium abrasion
<b>Operating temperature:</b>	-40°C to +100°C (-40°F to +212°F)		
<b>Qualified fittings:</b>	Z series		

PART #	SIZE DIMENSIONS				PRESSURE				BEND		WEIGHT	
	Hose I.D.		Hose O.D. (nominal)		Working Pressure		Min. Burst Pressure		Min. Bend Radius		Weight	
	mm	in	mm	in	bar	psi	bar	psi	mm	in	kg/m	lbs/ft
<b>H40004</b>	6,4	0.25	15,1	0.59	275,0	4,000	1000,0	16,000	50,8	2.00	0,36	0.24
<b>H40006</b>	9,5	0.38	19,2	0.75	275,0	4,000	1000,0	16,000	63,5	2.50	0,53	0.36
<b>H40008</b>	12,7	0.50	22,1	0.87	275,0	4,000	1000,0	16,000	88,9	3.50	0,64	0.43
<b>H40010</b>	15,9	0.62	25,7	1.01	275,0	4,000	1000,0	16,000	101,6	4.00	0,89	0.60
<b>H40012</b>	19,0	0.75	29,9	1.17	275,0	4,000	1000,0	16,000	120,7	4.75	1,07	0.72



# H421

Premium Hi-impulse jack  
two wire braided hose

Meets: IJ100

**Weatherhead** by Danfoss **H42104** 6.4 mm (0.25 in) DN6 **Dura-Tuff** MSHA IC-84/19 **690 BAR (10000 PSI)** -40°C to +49°C / -40°F to +120°F z

**Typical application:**

Hydraulic jacking system service with petroleum and water-based fluids  
Meets the performance requirements of the Material Handling Institute Specification IJ100

<b>Agency specifications:</b>	MSHA		
<b>Hose construction:</b>	<b>Inner tube:</b> Nitrile	<b>Reinforcement:</b> Two wire braid	<b>Cover:</b> Dura-Tuff premium abrasion
<b>Operating temperature:</b>	-40°C to +49°C (-40°F to +120°F)		
<b>Qualified fittings:</b>	Z series		

PART #	SIZE DIMENSIONS				PRESSURE				BEND		WEIGHT	
	Hose I.D.		Hose O.D. (nominal)		Working Pressure	Min. Burst Pressure		Min. Bend Radius		Weight		
	mm	in	mm	in	bar	psi	bar	psi	mm	in	kg/m	lbs/ft
<b>H42104</b>	6,4	0.25	14,1	0.56	690,0	10,000	1380,0	20,000	50,8	2.00	0,33	0.22
<b>H42106</b>	9,5	0.38	19,2	0.76	690,0	10,000	1380,0	20,000	63,5	2.50	0,57	0.38

Premium hose  
H850

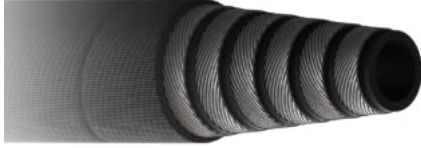

# H850

Premium Dynamax ultra-performance  
four & six wire spiral hose

Meets: SAE 100R15 | EN 856 R13 Type | ISO 18752

**Weatherhead** by Danfoss **EC85012** 19.0 mm (0.75 in) DN19 **Dura-Tuff Dynamax** Exceeds SAE 100R15 / EN 856 R13 Type ISO 18752 - MSHA IC-84/56 **500 BAR (7250 PSI)** -40°C to +100°C -40°F to +212°F **1W**

**Typical application:**

Ultra high pressure  
Hydraulic systems with petroleum and water-glycol based fluids  
Lubricating oils and water

<b>Agency specifications:</b>	MSHA		
<b>Hose construction:</b>	<b>Inner tube:</b> Nitrile	<b>Reinforcement:</b> Four wire spiral (-10, -12, -16) Six wire spiral (-20)	<b>Cover:</b> Dura-Tuff premium abrasion
<b>Operating temperature:</b>	-40°C to +100°C (-40°F to +212°F)		
<b>Qualified fittings:</b>	1W series		

PART #	SIZE DIMENSIONS				PRESSURE				BEND		WEIGHT	
	Hose I.D.		Hose O.D. (nominal)		Working Pressure		Min. Burst Pressure		Min. Bend Radius		Weight	
	mm	in	mm	in	bar	psi	bar	psi	mm	in	kg/m	lbs/ft
<b>H850-10</b>	15,9	0.62	27,9	1.10	500	7,250	2000	29,000	200,0	7.87	1,23	0.82
<b>H850-12</b>	19,0	0.75	32,2	1.27	500	7,250	2000	29,000	215,0	8.46	1,52	1.01
<b>H850-16</b>	25,4	1.00	39,2	1.54	500	7,250	2000	29,000	270,0	10.63	2,31	1.54
<b>H850-20**</b>	31,8	1.25	49,4	1.94	500	7,250	2000	29,000	380,0	14.96	4,01	2.69

\*\* Six wire spiral



# H464

Premium  
four wire spiral hose

Meets: EN 856 4SH | ISO 3862 4SH | ISO 18752

<b>Weatherhead</b> by Danfoss	<b>H46412</b>	19.0 mm (0.75 in) DN19	EN 856 4SH • ISO 3862 4SH ISO 18752 • MSHA IC-84/55	420 BAR (6100 PSI)	-40°C to +100°C -40°F to +212°F	<b>4S</b>
-------------------------------	---------------	---------------------------	--	--------------------	------------------------------------	-----------

**Typical application:**

High pressure hydraulic systems with petroleum and water-based fluids

<b>Agency specifications:</b>	MSHA		
<b>Hose construction:</b>	<b>Inner tube:</b> Nitrile	<b>Reinforcement:</b> Four wire spiral	<b>Cover:</b> Dura-Tuff premium abrasion
<b>Operating temperature:</b>	-40°C to +100°C (-40°F to +212°F)		
<b>Qualified fittings:</b>	1W series   4S series		

PART #	SIZE DIMENSIONS				PRESSURE				BEND		WEIGHT	
	Hose I.D.		Hose O.D. (nominal)		Working Pressure		Min. Burst Pressure		Min. Bend Radius		Weight	
	mm	in	mm	in	bar	psi	bar	psi	mm	in	kg/m	lbs/ft
<b>H46412</b>	19,0	0.75	32,2	1.27	420,0	61,00	1680,0	24,400	280,0	11.02	1,49	1.00
<b>H46416</b>	25,4	1.00	38,3	1.51	420,0	6,100	1680,0	24,400	340,0	13.39	2,05	1.38
<b>H46420</b>	31,8	1.25	45,5	1.79	350,0	5,100	1400,0	20,400	460,0	18.11	2,54	1.71
<b>H46424</b>	38,1	1.50	53,5	2.11	300,0	4,350	1200,0	17,400	560,0	22.05	3,27	2.20
<b>H46432</b>	50,8	2.00	68,1	2.68	250,0	3,650	1000,0	14,500	700,0	27.56	4,58	3.08



Premium hose  
H039



Suction

# H039

Premium suction hose

Exceeds: SAE 100R4 | EN 45545

**Weatherhead** by Danfoss **H03912** 19.0 mm (0.75 in) DN19 **Dura-Tuff** Exceeds SAE 100R4 - ABS MSHA IC-84/19 - USCG **21 BAR (305 PSI)** -40°C to +135°C / -40°F to +275°F 1/3 BEND Z

**Typical application:**

Suction and transfer applications for petroleum hydraulic fluids, fuel, lubricating oils, gasoline, water and many other industrial fluids

<b>Agency specifications:</b>	ABS   MSHA   USCG		
<b>Hose construction:</b>	<b>Inner tube:</b> CPE	<b>Reinforcement:</b> Helical wire between two textile reinforcement layers	<b>Cover:</b> Nitrile
<b>Operating temperature:</b>	-40°C to +135°C (-40°F to +275°F)		
<b>Qualified fittings:</b>	Z series (-12 to -32)   4S series (-12)   327E (-12 to -32)		

PART #	SIZE DIMENSIONS				PRESSURE				BEND		VACUUM		WEIGHT	
	Hose I.D.		Hose O.D. (nominal)		Working Pressure		Min. Burst Pressure		Min. Bend Radius		Vacuum Service		Weight	
	mm	in	mm	in	bar	psi	bar	psi	mm	in	kg/m	lbs/ft	kg/m	lbs/ft
<b>H03912</b>	19,0	0.75	30,0	1.18	21,0	305 †	84,0	1,200	40,0	1.57	94,8	28	0,65	0.44
<b>H03916</b>	25,4	1.00	37,1	1.46	17,0	245†	68,0	1,000	45,0	1.77	94,8	28	0,77	0.52
<b>H03920</b>	31,8	1.25	44,8	1.76	14,0	205 †	56,0	820	60,0	2.36	94,8	28	1,12	0.75
<b>H03924</b>	38,1	1.50	51,2	2.01	10,5	150 †	42,0	600	65,0	2.56	94,8	28	1,26	0.85
<b>H03932</b>	50,8	2.00	64,8	2.55	7,0	100 †	28,0	400	100,0	3.94	94,8	28	1,73	1.16
<b>H03940</b>	63,5	2.50	77,7	3.06	4,0	60 †	16,0	240	140,0	5.51	94,8	28	2,35	1.58
<b>H03948</b>	76,2	3.00	92,5	3.64	4,0	60 †	16,0	240	279,4	11.00	94,8	28	3,36	2.26

† Maximum working pressure for band clamp type fittings is 3,4 bar [50 psi].

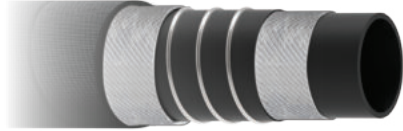

# H039H

Premium high-temp suction hose

Meets: SAE 100R4

<b>Weatherhead</b> by Danfoss	<b>H039H12</b>	19.0 mm (0.75 in) DN19	High-Temp	Exceeds SAE 100R4 MSHA IC-84/19	21 BAR (305 PSI)	-40°C to +149°C -40°F to +300°F	Z
-------------------------------	----------------	------------------------	-----------	---------------------------------	------------------	------------------------------------	---

**Typical application:**

Suction and transfer applications for petroleum hydraulic fluids, fuel, lubricating oils, gasoline, water and many other industrial fluids

<b>Agency specifications:</b>	MSHA		
<b>Hose construction:</b>	<b>Inner tube:</b> CPE	<b>Reinforcement:</b> Helical wire between two textile reinforcement layers	<b>Cover:</b> CPE
<b>Operating temperature:</b>	-40°C to +149°C (-40°F to +300°F)		
<b>Qualified fittings:</b>	Z series   327E fittings		

PART #	SIZE DIMENSIONS				PRESSURE				BEND		VACUUM		WEIGHT	
	Hose I.D.		Hose O.D. (nominal)		Working Pressure		Min. Burst Pressure		Min. Bend Radius		Vacuum Service		Weight	
	mm	in	mm	in	bar	psi	bar	psi	mm	in	kg/m	lbs/ft	kg/m	lbs/ft
<b>H039H12</b>	19,0	0.75	31,8	1.25	21,0	305 †	84,0	1,205	125,0	4.92	94,8	28	0,62	0.42
<b>H039H16</b>	25,4	1.00	38,0	1.50	17,5	255 †	70,0	1,000	150,0	5.91	94,8	28	0,74	0.50
<b>H039H20</b>	31,8	1.25	45,8	1.80	14,0	205 †	56,0	810	200,0	7.87	94,8	28	1,34	0.90
<b>H039H24</b>	38,1	1.50	53,1	2.09	11,0	160 †	44,0	640	255,0	10.04	94,8	28	1,68	1.13
<b>H039H32</b>	50,8	2.00	64,8	2.55	7,0	100 †	28,0	400	300,0	11.81	94,8	28	1,93	1.30
<b>H039H40</b>	63,5	2.50	78,0	3.07	4,5	65 †	18,0	260	355,0	13.98	94,8	28	2,56	1.72
<b>H039H48 ‡</b>	76,2	3.00	92,5	3.64	4,0	60 †	16,0	230	457,0	17.99	94,8	28	2,92	1.96
<b>H039H64 ‡</b>	101,6	4.00	119,1	4.69	3,5	50 †	14,0	205	610,0	24.02	94,8	28	4,58	3.08

† Maximum working pressure for band clamp type fittings is 3,4 bar [50 psi].







‡ Sold as bulk hose only.





## The **standard** hoses

Core hose 

Hose	Page	Hose	Page	Hose	Page
<b>EC115</b> Standard one wire braided hose 	66	<b>EC415</b> Standard four wire spiral hose 	69	<b>WH004</b> Standard suction hose 	71
<b>EC215</b> Standard two wire braided hose 	67	<b>EC420</b> Standard four & six wire spiral hose 	70		
<b>EC118</b> Premium one & two wire braided hose 	68				



## How to order

Accurate processing and prompt delivery of your order depends on easy identification of your requirements. Please order Weatherhead brand parts using correct part numbers as described in this guide. Inquiries and orders should be directed to your Weatherhead distributor or:

[www.Danfoss.com/hydraulics](http://www.Danfoss.com/hydraulics)

### Part numbers and dash sizes

Dash size designates the nominal size in 16th of an inch. This number immediately follows the part number and is separated from it with a dash.

### Dimensions

Dimensions given in this guide for Weatherhead products are approximate and should be used for reference only. Exact dimensional information for a given product is subject to change and varying tolerances; contact Danfoss directly for full current information.

## Number system - hydraulic hose

Cut lengths hoses are available only on core hose products. Available cut lengths are 50, 100, and 150 ft. The feet should be expressed in inches:

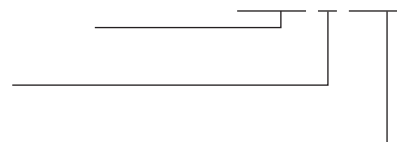

50 ft = 06000

100 ft = 12000

150 ft = 18000

Last digit is in 1/8 of an inch 00484 = 48 1/2 inches

Most core hoses are offered on reels of 250 or 500 ft lengths.

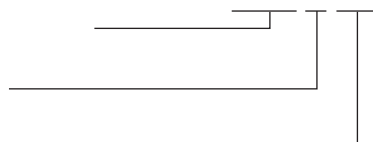

### WARNING

#### Hose assemblies

Danfoss manufactures the terminal ends of our hose fittings to the appropriate requirements established by the SAE. Therefore, the performance ratings of these hose fittings meet the SAE requirements. It is possible to order a hose assembly with a fitting terminal end that has a performance rating lower than the hose rating. When ordering hose assemblies, please keep the connecting end performance rating in mind since this may affect overall hose assembly performance. Hose assembly components (hose and fittings) are easily assembled in the field. However, factory assembled reusable and crimped hose assemblies are available.

For complete information, contact Danfoss.



# Winner

Standard core hose  
EC115



Standard

**EC115** | Winner  
one wire braid hose

Meets: SAE 100R1 | EN 857 Type 1SC

**Winner** by Danfoss **EC115-08** 12.7 MM (0.50 IN) DN12 | SAE 100R1 • EN 857 1SC MSHA IC-84/25 DNV • USCG+ | 160 BAR (2300 PSI) | -40°C to +100°C (-40°F to +212°F) | Half Bend | 1A • Z 2PC • 1R

### Typical application:

Hydraulic system service with petroleum and water based fluids, for general industrial service.

**Agency specifications:** DNV | MSHA | USCG

<b>Hose construction:</b>	<b>Inner tube:</b> Nitrile	<b>Reinforcement:</b> One wire braid	<b>Cover:</b> Nitrile
---------------------------	-------------------------------	---	--------------------------

**Operating temperature:** -40°C to +100°C (-40°F to +212°F)

**Qualified fittings/socket:** Fittings: Z series | 2-piece Winner | 1R field attachable  
Socket: 00110 (pg 157)

PART #	SIZE DIMENSIONS				PRESSURE				BEND		WEIGHT	
	Hose I.D.		Hose O.D. (nominal)		Working Pressure		Min. Burst Pressure		Min. Bend Radius		Weight	
	mm	in	mm	in	bar	psi	bar	psi	mm	in	kg/m	lbs/ft
<b>EC115-04</b>	6.4	0.25	12.6	0.50	225	3,250	900	13,000	50	1.97	0.18	0.12
<b>EC115-06</b>	9.5	0.38	16.1	0.63	180	2,600	720	10,400	63	2.48	0.26	0.17
<b>EC115-08</b>	12.7	0.50	19.5	0.77	160	2,300	640	9,200	90	3.54	0.34	0.23
<b>EC115-10</b>	15.9	0.62	22.5	0.88	130	1,900	520	7,600	100	3.94	0.42	0.28
<b>EC115-12</b>	19.0	0.75	26.0	1.02	105	1,525	420	6,100	120	4.72	0.50	0.34
<b>EC115-16</b>	25.4	1.00	33.9	1.33	88	1,275	352	5,100	160	6.30	0.74	0.50
<b>EC115-20</b>	31.8	1.25	40.9	1.61	63	925	252	3,700	210	8.27	0.99	0.67
<b>EC115-24</b>	38.1	1.50	48.0	1.89	50	725	300	4,350	300	11.81	1.20	0.81
<b>EC115-32</b>	50.8	2.00	61.0	2.40	40	580	220	3,190	400	15.75	1.50	1.01

Core | Premium | **Standard** | Braided | Spiral | High-Temp | Low-Temp | Abrasion | Suction



✓ Standard

# EC215

Winner  
two wire braid hose

Meets: EN 857 2SC | ISO 18752

**Winner** by Danfoss **EC215-06** 9.5 mm (0.38 in) DN10 | EN 857 2SC - ISO 18752 MSHA IC-84/41 • DNV • USCG + | 345 BAR (5000 PSI) | -40°C to +100°C -40°F to +212°F | Half Bend | 1A-Z 2R-2PC

**Typical application:**

Hydraulic system service with petroleum and water based fluids, for general industrial service.

<b>Agency specifications:</b>	MSHA   DNV   USCG		
<b>Hose construction:</b>	<b>Inner tube:</b> Nitrile	<b>Reinforcement:</b> Two wire braid	<b>Cover:</b> Nitrile
<b>Operating temperature:</b>	-40°C to +100°C (-40°F to +212°F)		
<b>Qualified fittings/socket:</b>	Fittings: Z series   2-piece Winner   2R field attachable Socket: 03310 (pg 157)		

PART #	SIZE DIMENSIONS				PRESSURE				BEND		WEIGHT	
	Hose I.D.		Hose O.D. (nominal)		Working Pressure		Min. Burst Pressure		Min. Bend Radius		Weight	
	mm	in	mm	in	bar	psi	bar	psi	mm	in	kg/m	lbs/ft
<b>EC215-04</b>	6.4	0.25	13.5	0.53	400	5,800	1,600	23,200	50	1.97	0.28	0.19
<b>EC215-06</b>	9.5	0.38	17.5	0.69	345	5,000	1,380	20,000	65	2.56	0.41	0.28
<b>EC215-08</b>	12.7	0.50	20.8	0.82	275	4,000	1,100	16,000	90	3.54	0.57	0.38
<b>EC215-10</b>	15.9	0.62	24.0	0.94	250	3,650	1,000	14,600	100	3.94	0.68	0.46
<b>EC215-12</b>	19.0	0.75	27.9	1.10	215	3,125	860	12,500	120	4.72	0.81	0.54
<b>EC215-16</b>	25.4	1.00	35.7	1.41	165	2,400	660	9,600	160	6.30	1.17	0.79
<b>EC215-20</b>	31.8	1.25	43.9	1.73	125	1,800	500	7,200	250	9.84	1.56	1.05
<b>EC215-24</b>	38.1	1.50	51.0	2.01	100	1,450	400	5,800	300	11.81	1.81	1.22
<b>EC215-32</b>	50.8	2.00	63.4	2.50	90	1,300	380	5,500	400	15.75	2.36	1.59

Core | Premium | **Standard** | Braided | Spiral | High-Temp | Low-Temp | Abrasion | Suction

# Winner

Standard core hose  
EC118



Standard

**EC118** | Winner  
one & two wire braid hose

Meets: SAE 100R17 | ISO 18752

**Winner** by Danfoss **EC118-08**
12.7 mm (0.50 in) DN12
SAE 100R17 • ISO 18752  
MSHA IC-84/41 • USCG ↕
 210 BAR (3050 PSI)
 -40°C to +100°C  
-40°F to +212°F
1A • Z 1R • 2pc

### Typical application:

Low and medium pressure hydraulic systems with petroleum and water-based fluids

Construction equipment and agriculture equipment

**Agency specifications:** MSHA | USCG

<b>Hose construction:</b>	<b>Inner tube:</b> Nitrile	<b>Reinforcement:</b> One wire braid (-04 to -08) Two wire braid (-10 to -16)	<b>Cover:</b> Nitrile
---------------------------	-------------------------------	---	--------------------------

**Operating temperature:** -40°C to +100°C (-40°F to +212°F)

**Qualified fittings/socket:** Fittings: Z series | 1R series (-04, -05, -06, -08) | 2-piece Winner  
Sockets: 00110 (-04, -06, -08) • 03310 (-10, -12, -16) (pg 157)

PART #	SIZE DIMENSIONS				PRESSURE				BEND		WEIGHT	
	Hose I.D.		Hose O.D. (nominal)		Working Pressure		Min. Burst Pressure		Min. Bend Radius		Weight	
	mm	in	mm	in	bar	psi	bar	psi	mm	in	kg/m	lbs/ft
<b>EC118-04</b>	6,4	0.25	12,5	0.49	210,0	3,050	840,0	12,200	50,0	1.97	0,18	0.12
<b>EC118-06</b>	9,5	0.38	16,1	0.63	210,0	3,050	840,0	12,200	65,0	2.56	0,27	0.18
<b>EC118-08</b>	12,7	0.50	19,9	0.78	210,0	3,050	840,0	12,200	90,0	3.54	0,36	0.24
<b>EC118-10**</b>	15,9	0.62	24,6	0.97	210,0	3,050	840,0	12,200	100,0	3.94	0,69	0.46
<b>EC118-12**</b>	19,0	0.75	28,8	1.13	210,0	3,050	840,0	12,200	120,0	4.72	0,81	0.54
<b>EC118-16**</b>	25,4	1.00	37,1	1.46	210,0	3,050	840,0	12,200	150,0	5.91	1,21	0.81

\*\* indicates two-wire braid

Core | Premium | **Standard** | Braided | Spiral | High-Temp | Low-Temp | Abrasion | Suction



✓ Standard

# EC415

Winner  
four wire spiral hose

Meets: SAE 100R12 | EN 856 R12 | ISO 18752

**Winner** by Danfoss **EC415-08** | 12.7 mm (0.50 in) DN12 | SAE 100R12 • EN 856 R12 • ISO 18752 MSHA IC-84/41 • USCG + | **280 BAR (4050 PSI)** | -40°C to +121°C (-40°F to +250°F) | **Half Bend** | **4S**

**Typical application:**

Hydraulic system service with petroleum and water based fluids, for general industrial service.

**Agency specifications:** MSHA | USCG

<b>Hose construction:</b>	<b>Inner tube:</b> Nitrile	<b>Reinforcement:</b> Four wire spiral	<b>Cover:</b> Nitrile
---------------------------	-------------------------------	---	--------------------------

**Operating temperature:** -40°C to +121°C (-40°F to +250°F)

**Qualified fittings:** 4S series

PART #	SIZE DIMENSIONS				PRESSURE				BEND		WEIGHT	
	Hose I.D.		Hose O.D. (nominal)		Working Pressure		Min. Burst Pressure		Min. Bend Radius		Weight	
	mm	in	mm	in	bar	psi	bar	psi	mm	in	kg/m	lbs/ft
<b>EC415-06</b>	9.5	0.38	20,3	0.80	280	4,050	1,120	16,200	63	2.48	0.60	0.40
<b>EC415-08</b>	12.7	0.50	23,8	0.94	280	4,050	1,120	16,200	90	3.54	0.74	0.50
<b>EC415-10</b>	15.9	0.62	27,7	1.09	280	4,050	1,120	16,200	100	3.94	1.03	0.69
<b>EC415-12</b>	19.0	0.75	30,7	1.21	280	4,050	1,120	16,200	120	4.72	1.16	0.78
<b>EC415-16</b>	25.4	1.00	38,0	1.50	280	4,050	1,120	16,200	150	5.91	1.76	1.18
<b>EC415-20</b>	31.8	1.25	47,0	1.85	210	3,050	840	12,200	210	8.27	2.46	1.65
<b>EC415-24</b>	38.1	1.50	53,5	2.11	207	3,000	827	12,000	250	9.84	2.87	1.92
<b>EC415-32</b>	50.8	2.00	66,7	2.63	207	3,000	827	12,000	320	12.60	4.03	2.70

Core | Premium | **Standard** | Braided | **Spiral** | High-Temp | Low-Temp | Abrasion | Suction

# Winner

Standard core hose  
EC420

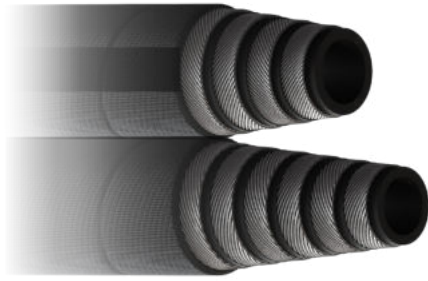

✓ Standard

**EC420** | Winner  
four & six wire spiral hose

Meets: SAE 100R13 | EN 856 R13 | ISO 18752

**Winner** by Danfoss **EC420-12** 19 mm (0.75 in) DN19 | SAE 100R13 • EN 856 R13 • ISO 18752 MSHA IC-84/41 • DNV • USCG + | **350 BAR (5100 PSI)** | -40°C to +121°C (-40°F to +250°F) | Half Bend | 4S

### Typical application:

Suitable for use in hydraulic systems with high peak pressures and arduous operating conditions.

<b>Agency specifications:</b>	MSHA   DNV   USCG		
<b>Hose construction:</b>	<b>Inner tube:</b> Nitrile	<b>Reinforcement:</b> Four wire spiral (-12, -16) Six wire spiral (-20 to -32)	<b>Cover:</b> Nitrile
<b>Operating temperature:</b>	-40°C to +121°C (-40°F to +250°F)		
<b>Qualified fittings:</b>	4S series (12, -16)   6S series (-20 to -32)		

PART #	SIZE DIMENSIONS				PRESSURE				BEND		WEIGHT	
	Hose I.D.		Hose O.D. (nominal)		Working Pressure		Min. Burst Pressure		Min. Bend Radius		Weight	
	mm	in	mm	in	bar	psi	bar	psi	mm	in	kg/m	lbs/ft
<b>EC420-12</b>	19,0	0.75	32,1	1.27	350	5,100	1,400	20,400	120	4.72	1.54	1.03
<b>EC420-16</b>	25,4	1.00	38,7	1.53	350	5,100	1,400	20,400	150	5.91	2.01	1.35
<b>EC420-20**</b>	31,8	1.25	49,8	1.96	350	5,100	1,400	20,400	210	8.27	3.78	2.54
<b>EC420-24**</b>	38,1	1.50	57,3	2.26	350	5,100	1,400	20,400	250	9.84	4.73	3.18
<b>EC420-32**</b>	50,8	2.00	71,5	2.81	350	5,100	1,400	20,400	315	12.40	7.26	4.88

\*\* 6 wire spiral

Core | Premium | **Standard** | Braided | **Spiral** | High-Temp | Low-Temp | Abrasion | Suction

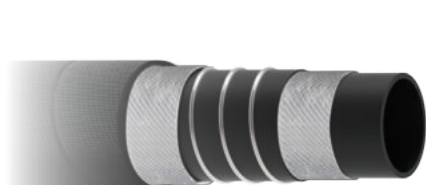

✓ Standard

# WH004

Winner suction & return hose

Exceeds: SAE 100R4 performance

**Winner** by Danfoss **WH004-12**
19 mm (0.75 in) DN19
Exceeds SAE 100R4 PERFORMANCE MSHA IC-261/5
21 BAR (305 PSI)
-40°C to +100°C  
-40°F to +212°F
Half Bend
1A-Z 1G-2pc

**Typical application:**

Suitable for use in suction applications for hydraulics, crude fuel, lubricating oils, gasoline, air, water and chemical transfer

<b>Agency specifications:</b>	MSHA		
<b>Hose construction:</b>	<b>Inner tube:</b> Oil-resistant NBR	<b>Reinforcement:</b> Textile with helical & anti-static wire	<b>Cover:</b> Nitrile
<b>Operating temperature:</b>	-40°C to +100°C (-40°F to +212°F)		
<b>Qualified fittings/socket:</b>	Fittings: • Z series & 327E fittings: -12, -16, -20, -24 and -32 • 4T Optimum & Winner 2 pc series: -12 and -16 • Hose barb with band clamps: -12 thru -48 with a reduced operating pressure rating of 4 bar (60 psi) Socket: 03310 (pg 157)		

PART #	SIZE DIMENSIONS				PRESSURE				BEND		VACUUM		WEIGHT	
	Hose I.D.		Hose O.D. (nominal)		Working Pressure		Min. Burst Pressure		Min. Bend Radius		Vacuum Service		Weight	
	mm	in	mm	in	bar	psi	bar	psi	mm	in	kPa	in/Hg	kg/m	lbs/ft
<b>WH004-12</b>	19,0	0.75	28,6	1.13	21	305	84	1220 †	40	1.57	94.8	28	0,54	0.36
<b>WH004-16</b>	25,4	1.00	35,2	1.39	17	245	68	980 †	45	1.77	94.8	28	0,68	0.46
<b>WH004-20</b>	31,8	1.25	42,0	1.65	14	205	56	820 †	60	2.36	94.8	28	0,85	0.57
<b>WH004-24</b>	38,1	1.50	49,2	1.94	10.5	150	42	600 †	65	2.56	94.8	28	1,20	0.81
<b>WH004-32</b>	50,8	2.00	62,0	2.44	7	100	28	400 †	100	3.94	94.8	28	1,53	1.03
<b>WH004-40</b>	63,5	2.50	75,5	2.97	4	60	16	240 †	140	5.51	94.8	28	2,05	1.38
<b>WH004-48</b>	76,2	3.00	88,0	3.46	4	60	16	240 †	180	7.09	94.8	28	2,62	1.76

† Maximum working pressure for band clamp type fittings is 3,4 bar [50 psi]





Weatherhead by Danfoss

## **Braided fittings**

Braided series fittings



























# Weatherhead

Hose to fitting chart

Match the fitting  
to the braided

Premium core hose:     

Standard core hose: 

Global Z fittings (pg. 78 - 142)			Global OTC fittings (pg. 78 - 142)		
For use with hose:		See hose page:	For use with hose:		See hose page:
<b>H180</b>		39	<b>H039</b>		60
<b>H145R</b>		40	<b>H039H</b>		61
<b>H190H</b>		41	<b>WH004</b>		71
<b>H280</b>		42	Two-piece Winner (pg. 157 - 167)		
<b>H881</b>		43	For use with hose:		See hose page:
<b>H290H</b>		44	<b>EC115</b>		66
<b>H245L</b>		45	<b>EC215</b>		67
<b>H190</b>		52	<b>EC118</b>		68
<b>H400</b>		56	<b>WH004</b>		71
<b>H290</b>		53	Reusable 1R fittings (pg 144 - 148)		
<b>H421</b>		57	For use with hose:		See hose page:
<b>H039</b>		60	<b>H180</b>		39
<b>H039H</b>		61	<b>EC115</b>		66
<b>EC115</b>		66	<b>EC118</b>		68
<b>EC215</b>		67	Reusable 2R fittings (pg 149 - 153)		
<b>EC118</b>		68	For use with hose:		See hose page:
<b>WH004</b>		71	<b>H280</b>		42
			<b>H290</b>		53
			<b>EC215</b>		67

The next generation technology of Danfoss 'Z' Series hose ends are compatible with the most Weatherhead standard and newer generation hose styles combining best-in-class technologies to meet and exceed the highest globally recognized standards for 1 and 2 wire braid hydraulic hose assemblies.

The total array of over 550 'Z' Series hose ends meets virtually all customer needs for domestic and non-North American thread styles and configurations. The resulting hose assemblies provide superior performance in the demanding applications often encountered within mobile and industrial equipment.

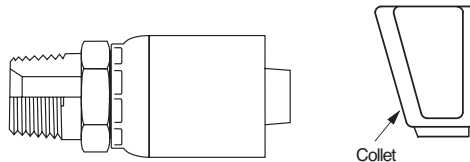

**Ordering information:** Order individually by catalog number. O-rings not supplied with flange hose ends. Order O-rings by catalog number; reference individual listings for details. For split flange kits refer to pages 228 - 230 and for O-rings refer to pages 231 - 234.

**Note:** Refer to current price list for availability of cataloged items. Configurations and dimensions subject to change without notice.

**Pressure:** Determined by maximum working pressure for hose size and hose end configuration whichever is less. For working pressure ratings for hose end configurations, refer to pages 336 - 337.

**Material:** low carbon steel

**Plating:** trivalent zinc plated

**Assemble with:**  
T-400-1, T-410-1, T-420-1, T-440, T-460, T-462, T-465, T-480, ET1000, ET1187, ET4000, ET4001, FT1380, FT1390, ET4020 and ET4040.

**Label set:** FF90645

**Application:** General purpose low, medium, and high pressure hydraulic.

**Advantages:**  
Wide selection of hose and end configurations allowing a diverse number of applications.

To determine the correct length of hose, subtract the cut-off factor for each end fitting from the overall length of assembly.

Scribe line

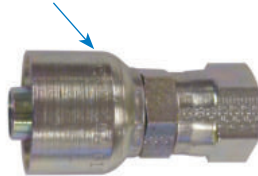

**Easy assembly**

Z Series hose ends are assembled with Weatherhead hose using existing positive stop and variable crimp machines.

The hose ends have a scribe line around the circumference of the socket to easily identify the location where the collets and variable crimp dies are positioned for crimping.

"Bite-the-wire" technology

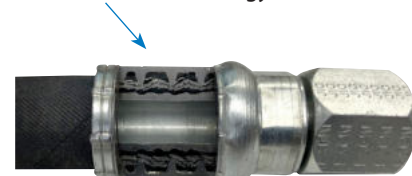

**Higher operating and burst pressure**

Z Series hose ends feature advanced "Bite-the-wire" technology:

- Advanced "Bite-the-wire" design provides higher operating and burst pressure
- Eliminates cool down leakage
- Flat crimp for easier routing
- Compatible with multiple hose styles to accommodate most application needs

## Weatherhead

### Hose installation and maintenance

Proper installation of the hose is essential to the proper operation and safe use of the hose and related equipment. Improper installation of the hose can result in serious injury or property damage caused by spraying fluids or flying projectiles. In order to avoid serious bodily injury or property damage resulting from improper installation of the hose, you should carefully review the information in this catalog regarding hose installation.

Some of the factors you must consider in installing the hose properly are:

- Changes in length
- Proper bend radius
- Protection from high temperature sources
- Elbows and adapters to relieve strain
- Rubbing or abrasion
- Twisting
- Improper hose movement

These factors and the other information in this catalog regarding hose installation should be considered by you before installing the hose. If you have any questions regarding proper hose installation, please contact Danfoss Technical Support.

Proper maintenance of the hose is essential to the safe use of the hose and related equipment. Hose should be stored in a dry place. Hose should also be visually inspected. Any hose that has a cut or gouge in the cover that exposes the reinforcement should be retired from service. Hoses should also be inspected for kinking or broken reinforcement. If the outside diameter of the hose is reduced by 20% at the spot where it is bent then the hose should be retired from service. Inadequate attention to maintenance of the hose can result in hose leakage, bursting, or other failure which can cause serious bodily injury or property damage from spraying fluids, flying projectiles, or other substances.

#### **WARNING**

Danfoss fitting tolerances are engineered to match approved Danfoss hose tolerances. The use of Danfoss fittings on hose supplied by other manufacturers and/or the use of Danfoss hoses with fittings supplied by other manufactures may result in the production of unreliable and unsafe hose assemblies and is neither recommended nor authorized by Danfoss or any of its affiliates or subsidiaries.

#### **WARNING**

Application considerations must be observed in selecting appropriate components for the application of these products contained herein. The failure to follow the recommendations set forth in this catalog may result in an unstable application which may result in serious personal injury or property damage.

Failure to follow these processes and product instructions and limitations could lead to premature hose assembly failures resulting in property damage, serious injury or death.

**DANFOSS OR ANY OF ITS AFFILIATES OR SUBSIDIARIES SHALL NOT BE SUBJECT TO AND DISCLAIMS ANY OBLIGATIONS OR LIABILITIES (INCLUDING BUT NOT LIMITED TO ALL CONSEQUENTIAL, INCIDENTAL AND CONTINGENT DAMAGES) ARISING FROM TORT CLAIMS (INCLUDING WITHOUT LIMITATION NEGLIGENCE AND STRICT LIABILITY) OR OTHER THEORIES OF LAW WITH RESPECT TO ANY HOSE ASSEMBLIES NOT PRODUCED FROM GENUINE DANFOSS HOSE FITTINGS, HOSE AND DANFOSS APPROVED EQUIPMENT, AND IN CONFORMANCE WITH DANFOSS' PROCESS AND PRODUCT INSTRUCTIONS FOR EACH SPECIFIC HOSE ASSEMBLY.**

Fitting descriptions and part #s		
Description	Part # example	See page:
Male Pipe Rigid	08Z-108	78
Male Pipe Swivel	08Z-J08	79
Female Pipe Rigid	08Z-208	80
Female Pipe Swivel	08Z-258	81
Female Straight Pipe Swivel (NPSM)	08Z-058	82
Male Pipe Swivel 90° Elbow	08Z-M08	83
JIC/37° Female Swivel	08Z-608	84-85
JIC/37° Female Swivel 30° Tube Elbow	10Z-L22	86
JIC/37° Female Swivel 45° Tube Elbow	08Z-688	87
JIC/37° Female Swivel 90° Tube Elbow	08Z-668	88
JIC/37° Female Swivel 90° Long Drop Tube Elbow	08Z-648	89
JIC/37° Male Rigid	08Z-508	90
SAE 45° Female Swivel	08Z-408	91
SAE 45° Female Swivel 45° Tube Elbow	06Z-486	92
SAE 45° Female Swivel Long Drop 90° Tube Elbow	06Z-446	93
SAE 45° Flare Male Rigid	06Z-306	94
Female ORS Swivel	08Z-568	95
Female ORS Swivel 45° Tube Elbow	08Z-L68	96
Female ORS Swivel Short Drop 90° Tube Elbow	08Z-A28	97
Female ORS Swivel Medium Drop 90° Tube Elbow	08Z-J38	98
Female ORS Swivel Long Drop 90° Tube Elbow	08Z-A68	99
ORS Male Rigid	08Z-E68	100
Male Straight Thread O-ring Rigid	08Z-P08	101
Male Straight Thread O-ring Swivel	08Z-R08	102
Male Straight Thread O-ring Swivel 90° Elbow	08Z-R68	103
Flareless Tube Rigid Ermeto 7000 Series	08Z-758	104
Flareless 45° Tube Elbow 7000 Ermeto Series	06Z-956	105
Flareless 90° Tube Elbow 7000 Ermeto Series	06Z-976	106
Inverted Male Swivel Straight	08Z-B08	107
Inverted Male Swivel 45° Tube Elbow	08Z-B48	108
Inverted Male Swivel 90° Tube Elbow	08Z-B68	109
Split Flange Straight (SAE Code 61)	12Z-G12	110
Split Flange 22.5° Tube Elbow (SAE Code 61)	16Z-H03	111
Split Flange 45° Tube Elbow (SAE Code 61)	12Z-G42	112
Split Flange 60° Tube Elbow (SAE Code 61)	16Z-H53	113
Split Flange 67° tube elbow (SAE Code 61)	20Z-H60	114
Split Flange 90° Tube Elbow (SAE Code 61)	12Z-G72	115
Metric Split Flange Straight (Komatsu, Linkbelt, etc.)	10Z-G09	116
Metric Split Flange 45° Tube Elbow (Komatsu, Linkbelt, etc.)	10Z-G69	117
Metric Split Flange 90° Tube Elbow (Komatsu, Linkbelt, etc.)	10Z-G99	118
READY-LOK® Male Connector	08Z-08S	119
Standpipe Straight Tube	08Z-T08	120
Metric Standpipe Straight Tube	08Z-45T	121
Pressure Washer Connection	06Z-6PW	122
BSPP Flat Face Female Swivel	08Z-08PA	123
British Standard (BSPP) 60° Cone Female Swivel Straight	08Z-358	124
British Standard (BSPP) 60° Cone Female 45° Tube Elbow	08Z-48P	125
British Standard (BSPP) 60° Cone Female 90° Tube Elbow	08Z-78P	126
British Standard (BSPT) Tapered Male Rigid	08Z-158	127
British Standard (BSPP) 60° Cone Male Rigid	08Z-P58	128
Female JIS 30° Flare Swivel Straight	08Z-08L	129
Female Swivel 30° Flare (Komatsu, Linkbelt)	08Z-22K	130
Female Swivel DIN 24° Seat I.Rh DKO (Light)	08Z-15C	131
Female Swivel DIN Universal Seat 45° Tube Elbow (Light)	08Z-15D	132
Female Swivel DIN Universal Seat 90° Tube Elbow (Light)	08Z-65D	133
Male DIN 24° Seat I.Rh (Light)	08Z-15A	134
Female Swivel DIN 24° Seat s.Rh DKO (Heavy)	08Z-64C	135
Female Swivel DIN 24° Seat 45° Tube Elbow s.Rh (Heavy)	08Z-16E	136
Female Swivel DIN 24° Seat 90° Tube Elbow s.Rh DKO (Heavy)	08Z-66E	137
Male DIN 24° Seat s.Rh (Heavy)	08Z-16F	138
STC Male Straight	08Z-BC08	139
STC Male 45° Tube Elbow	08Z-BC48	140
STC Male 90° Tube Elbow	08Z-BC68	141
STC Male 90° Long Drop Tube Elbow	08Z-BC88	142

Braided series

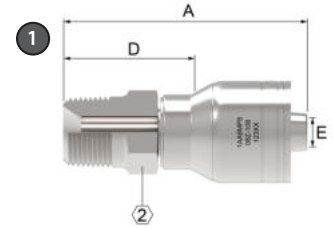

## Male Pipe Rigid

PART	HOSE SIZE INFO		DIMENSIONS						
	Z part #	Thd.	Hose size	A		D		EØ	
	in		mm	in	mm	in	mm	in	in
<b>04Z-102</b>	1/8-27	-04	46,7	1.84	23,4	0.92	4,3	0.17	9/16
<b>04Z-104</b>	1/4-18	-04	52,3	2.06	29,0	1.14	4,3	0.17	9/16
<b>04ZR-104*</b>	1/4-18	-04	52,3	2.06	29,0	1.14	4,3	0.17	9/16
<b>04Z-106</b>	3/8-18	-04	48,3	1.90	24,9	0.98	4,3	0.17	11/16
<b>04Z-108</b>	1/2-14	-04	51,3	2.02	31,2	1.23	4,3	0.17	7/8
<b>06Z-104</b>	1/4-18	-06	55,4	2.18	30,0	1.18	6,6	0.26	11/16
<b>06Z-106</b>	3/8-18	-06	57,7	2.27	32,5	1.28	6,6	0.26	11/16
<b>06ZR-106*</b>	3/8-18	-06	57,7	2.27	32,5	1.28	6,6	0.26	11/16
<b>06Z-108</b>	1/2-14	-06	57,7	2.27	32,5	1.28	4,1	0.16	7/8
<b>08Z-104</b>	1/4-18	-08	61,0	2.40	31,2	1.23	7,6	0.30	13/16
<b>08Z-106</b>	3/8-18	-08	63,2	2.49	33,5	1.32	9,7	0.38	13/16
<b>08Z-108</b>	1/2-14	-08	69,6	2.74	39,6	1.56	9,7	0.38	7/8
<b>08ZR-108*</b>	1/2-14	-08	69,6	2.74	39,6	1.56	9,7	0.38	7/8
<b>08Z-112</b>	3/4-14	-08	65,0	2.56	35,3	1.39	9,7	0.38	11/16
<b>10Z-106</b>	3/8-18	-10	59,9	2.36	33,8	1.33	10,7	0.42	15/16
<b>10Z-108</b>	1/2-14	-10	69,6	2.74	40,1	1.58	12,7	0.50	15/16
<b>10Z-112</b>	3/4-14	-10	65,0	2.56	35,6	1.40	12,7	0.50	11/16
<b>12Z-108</b>	1/2-14	-12	70,6	2.78	40,6	1.60	14,2	0.56	11/8
<b>12Z-112</b>	3/4-14	-12	72,1	2.84	41,9	1.65	15,5	0.61	11/8
<b>12ZR-112*</b>	3/4-14	-12	72,1	2.84	41,9	1.65	15,5	0.61	11/8
<b>12Z-116</b>	1-111/2	-12	71,1	2.80	40,9	1.61	15,5	0.61	13/8
<b>16Z-112</b>	3/4-14	-16	76,7	3.02	42,4	1.67	19,3	0.76	13/8
<b>16Z-116</b>	1-111/2	-16	81,8	3.22	47,2	1.86	20,8	0.82	13/8
<b>16ZR-116*</b>	1-111/2	-16	81,8	3.22	47,2	1.86	20,8	0.82	13/8
<b>16Z-120</b>	11/4-111/2	-16	78,2	3.08	43,7	1.72	20,8	0.82	111/16
<b>20Z-116</b>	1-111/2	-20	93,0	3.66	49,0	1.93	24,1	0.95	13/4
<b>20Z-120</b>	11/4-111/2	-20	89,4	3.52	45,5	1.79	26,7	1.05	113/16
<b>24Z-124</b>	11/2-111/2	-24	106,2	4.18	59,9	2.36	32,0	1.26	2
<b>32Z-132</b>	2-111/2	-32	116,6	4.59	66,3	2.61	44,5	1.75	21/2



Braided series

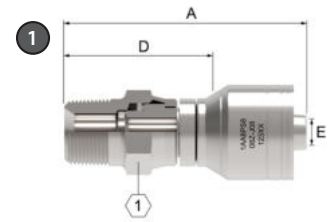

## Male Pipe Swivel

PART ① Z part #	HOSE SIZE INFO		DIMENSIONS						
	Thd.	Hose size	A		D		EØ		①
	in		mm	in	mm	in	mm	in	in
<b>04Z-J04</b>	1/4-18	-04	64,5	2.54	41,4	1.62	4,3	0.17	3/4
<b>06Z-J04</b>	1/4-18	-06	63,5	2.54	42,4	1.67	6,6	0.26	3/4
<b>06Z-J06</b>	3/8-18	-06	67,6	2.66	42,4	1.67	6,6	0.26	7/8
<b>06Z-J08</b>	1/2-14	-06	72,4	2.85	47,0	1.85	6,6	0.26	7/8
<b>08Z-J06</b>	3/8-18	-08	73,2	2.88	43,4	1.71	9,7	0.38	7/8
<b>08Z-J08</b>	1/2-14	-08	79,5	3.13	49,8	1.96	9,7	0.38	15/16
<b>12Z-J12</b>	3/4-14	-12	82,3	3.24	52,1	2.05	15,5	0.61	13/8
<b>16Z-J16</b>	1-11/2	-16	98,6	3.88	64,3	2.53	20,6	0.81	11/2

# Weatherhead

Braided series

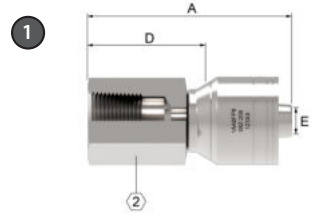

## Female Pipe Rigid

PART	HOSE SIZE INFO		DIMENSIONS						
	Z part #	Thd.	Hose size	A		D		EØ	
	in		mm	in	mm	in	mm	in	in
<b>04Z-202</b>	1/8-27	-04	52,6	2.07	32,5	1.28	4,3	0.17	9/16
<b>04Z-204</b>	1/4-18	-04	58,4	2.30	38,4	1.51	4,3	0.17	3/4
<b>06Z-204</b>	1/4-18	-06	58,4	2.30	37,1	1.46	6,6	0.26	3/4
<b>06Z-206</b>	3/8-18	-06	61,2	2.41	39,9	1.57	6,6	0.26	7/8
<b>08Z-208</b>	1/2-14	-08	66,5	2.62	42,0	1.65	9,7	0.38	11/16
<b>12Z-212</b>	3/4-14	-12	90,9	3.58	64,0	2.52	15,5	0.61	15/16

Braided series

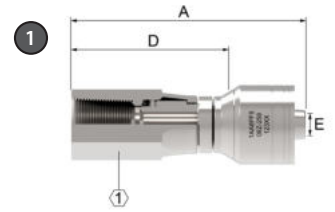

## Female Pipe Swivel

PART ① Z part #	HOSE SIZE INFO		DIMENSIONS						
	Thd.	Hose size	A		D		EØ		①
	in		mm	in	mm	in	mm	in	in
<b>04Z-254</b>	1/4-18	-04	72,9	2.87	49,5	1.95	4,3	0.17	3/4
<b>06Z-256</b>	3/8-18	-06	75,4	2.97	50,0	1.97	6,6	0.26	7/8
<b>08Z-258</b>	1/2-14	-08	90,9	3.58	61,2	2.41	9,7	0.38	11/16
<b>12Z-262</b>	3/4-14	-12	92,2	3.63	62,0	2.44	15,5	0.61	13/8
<b>16Z-266</b>	1-11/2	-16	111,0	4.37	77,5	3.05	20,6	0.81	15/8

# Weatherhead

Braided series



## Female Straight Pipe Swivel (NPSM)

PART	HOSE SIZE INFO		DIMENSIONS							
	Z part #	Thd.	Hose size	A		D		EØ		1
	in		mm	in	mm	in	mm	in	in	in
<b>04Z-054</b>	1/4-18	-04	47,8	1.88	27,7	1.09	4,3	0.17	11/16	9/16
<b>06Z-056</b>	3/8-18	-06	51,8	2.04	30,5	1.20	6,6	0.26	7/8	11/16
<b>08Z-058</b>	1/2-14	-08	61,0	2.40	35,8	1.41	9,7	0.38	1	7/8
<b>12Z-062</b>	3/4-14	-12	66,5	2.62	39,6	1.56	15,5	0.61	11/4	11/8
<b>16Z-066</b>	1 -11/2	-16	79,0	3.11	29,9	1.18	20,8	0.81	11/2	13/8
<b>20Z-070</b>	1 1/4 -11/2	-20	92,7	3.65	53,3	2.10	26,7	1.05	17/8	13/4

Braided series

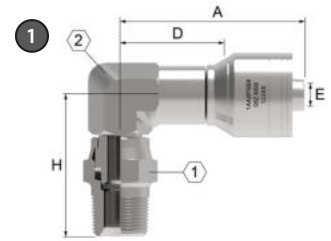

## Male Pipe Swivel 90° elbow

PART	HOSE SIZE INFO		DIMENSIONS										
	Z part #	Thd.	Hose size	A		D		EØ		1	2	H	
	in		mm	in	mm	in	mm	in	in	in	in	in	mm
<b>04Z-M04</b>	1/4-18	-04	54,6	2.15	31,2	1.23	4,3	0.17	3/4	3/4	1.81	46.1	
<b>06Z-M04</b>	1/4-18	-06	54,9	2.16	33,7	1.33	6,6	0.26	7/8	3/4	1.96	49.7	
<b>06Z-M06</b>	3/8-18	-06	59,2	2.33	33,7	1.33	6,6	0.26	7/8	3/4	1.80	45.8	
<b>08Z-M08</b>	1/2-14	-08	68,1	2.68	38,3	1.51	9,6	0.38	15/16	3/4	2.05	52.1	
<b>12Z-M12</b>	3/4-14	-12	94,5	3.72	64,2	2.53	15,4	0.61	13/8	11/4	2.72	69.2	

Braided series

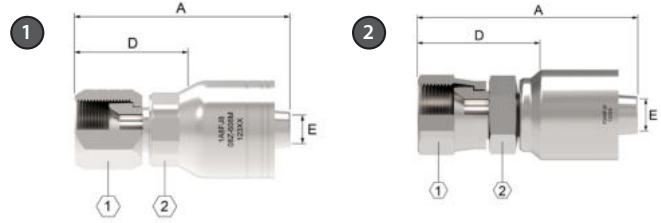

## JIC/37° Female Swivel

PART		HOSE SIZE INFO		DIMENSIONS							
1 Z part #	2 327E part #	Thd.	Hose size	A		D		EØ		1	2
		in		mm	in	mm	in	mm	in	in	in
<b>04Z-603</b>	<b>32706E-606</b>	3/8-24	-04	49,3	1.94	25,9	1.02	3,3	0.13	1/2	9/16
<b>04Z-604<sup>a</sup></b>		7/16-20	-04	50,8	2.00	26,8	1.05	4,3	0.17	9/16	9/16
<b>04ZR-604<sup>a</sup></b>		7/16-20	-04	50,8	2.00	27,2	1.07	4,3	0.17	9/16	9/16
<b>04Z-605<sup>a</sup></b>		1/2-20	-04	50,3	1.98	28,9	1.14	4,3	0.17	5/8	9/16
<b>04Z-606</b>		9/16-18	-04	51,6	2.03	28,2	1.11	4,3	0.17	11/16	9/16
<b>06Z-604</b>		7/16-20	-06	55,6	2.19	30,2	1.19	4,3	0.17	9/16	11/16
<b>06Z-605</b>		1/2-20	-06	56,9	2.24	31,5	1.24	5,8	0.23	5/8	11/16
<b>06Z-606</b>	<b>32706E-606</b>	9/16-18	-06	57,9	2.28	32,5	1.28	6,6	0.26	11/16	11/16
<b>06ZR-606<sup>a</sup></b>		9/16-18	-06	57,9	2.28	32,5	1.28	6,6	0.26	11/16	11/16
<b>06Z-608</b>		3/4-16	-06	58,7	2.31	33,3	1.31	6,6	0.26	7/8	11/16
<b>06Z-610</b>		7/8-14	-06	57,4	2.26	13,2	0.52	6,6	0.26	1	13/16
<b>06Z-612</b>		11/16-12	-06	59,5	2.34	38,4	1.51	6,7	0.26	11/4	1
<b>08Z-606</b>		9/16-18	-08	59,9	2.36	34,5	1.36	9,6	0.33	11/16	13/16
<b>08Z-608</b>	<b>32708E-608</b>	3/4-16	-08	66,8	2.63	37,1	1.46	9,7	0.38	7/8	13/16
<b>08ZR-608<sup>a</sup></b>		3/4-16	-08	66,8	2.63	37,1	1.46	9,7	0.38	7/8	13/16
<b>08Z-610</b>		7/8-14	-08	67,1	2.64	37,3	1.47	9,7	0.38	1	13/16
<b>08Z-612</b>		11/16-12	-08	69,3	2.73	39,6	1.56	9,7	0.38	11/4	1
<b>08Z-616</b>		15/16-12	-08	77,7	3.06	48,0	1.89	9,7	0.38	11/2	11/4

<sup>a</sup> Swivel nuts are universal – both SAE 37° and 45° connections.

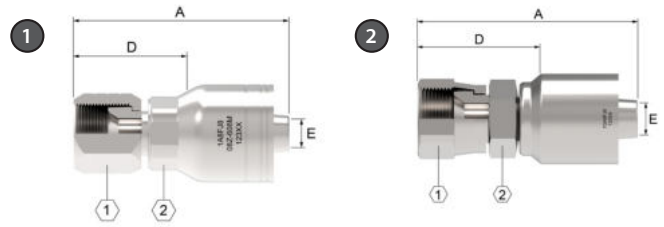

## JIC/37° Female Swivel (cont)

PART		HOSE SIZE INFO		DIMENSIONS							
1 Z part #	2 327E part #	Thd.	Hose size	A		D		EØ		1	2
		in		mm	in	mm	in	mm	in	in	in
<b>10Z-608</b>		3/4-16	-10	67,3	2.65	38,1	1.50	9,9	0.39	7/8	15/16
<b>10Z-610</b>	<b>32710E-610</b>	7/8-14	-10	70,4	2.77	40,9	1.61	12,7	0.50	1	15/16
<b>10ZR-610<sup>a</sup></b>		7/8-14	-10	70,4	2.77	40,9	1.61	12,7	0.50	1	15/16
<b>10Z-612<sup>a</sup></b>		11/16-12	-10	69,1	2.72	39,9	1.57	12,7	0.50	11/4	1
<b>12Z-608</b>		3/4-16	-12	66,0	2.60	38,8	1.53	9,9	0.39	7/8	1-1/8
<b>12Z-610</b>		7/8-14	-12	71,4	2.81	41,4	1.63	12,2	0.48	1	1-1/8
<b>12Z-612<sup>a</sup></b>	<b>32712E-612</b>	11/16-12	-12	72,1	2.84	41,9	1.65	15,5	0.61	1-1/4	1-1/8
<b>12ZR-612<sup>a</sup></b>		11/16-12	-12	72,1	2.84	41,9	1.65	15,5	0.61	1-1/4	1-1/8
<b>12Z-614<sup>a</sup></b>		13/16-12	-12	72,1	41,4	41,9	1.65	15,5	0.61	1-3/8	1-1/8
<b>12Z-616<sup>a</sup></b>		15/16-12	-12	73,9	2.91	43,7	1.72	15,5	0.61	1-1/2	1-1/4
<b>16Z-612</b>		11/16-12	-16	80,0	3.15	45,7	1.80	15,5	0.61	1-1/4	1-3/8
<b>16Z-614</b>		1 3/16-12	-16	80,0	3.15	46,5	1.83	20,6	0.81	1-3/8	1-3/8
<b>16Z-616<sup>a</sup></b>		15/16-12	-16	83,6	3.29	49,0	1.93	20,6	0.81	1-1/2	1-3/8
<b>16ZR-616</b>		15/16-12	-16	83,6	3.29	49,0	1.93	20,6	0.81	1-1/2	1-3/8
<b>16Z-620<sup>a</sup></b>		15/8-12	-16	80,5	3.17	46,0	1.81	20,6	0.81	2	-
<b>20Z-616</b>		15/16-12	-20	87,9	3.46	43,9	1.73	21,6	0.85	1-1/2	-
<b>20Z-620</b>		15/8-12	-20	91,7	3.61	47,8	1.88	26,7	1.05	2	-
<b>24Z-624</b>		17/8-12	-24	99,1	3.90	52,6	2.07	32,0	1.26	2-1/4	-
<b>32Z-63<sup>a</sup></b>		21/2-12	-32	110,2	4.34	60,7	2.39	44,5	1.75	2-7/8	-

<sup>a</sup> Swivel nuts are universal – both SAE 37° and 45° connections.



**Weatherhead**

Braided series

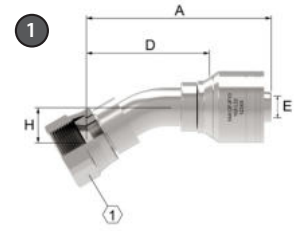
**JIC/37° Female Swivel 30° tube elbow**

PART	HOSE SIZE INFO		DIMENSIONS									
	Z part #	Thd.	Hose size	A		D		EØ		1	H	
	in		mm	in	mm	in	mm	in	in	in	in	mm
<b>10Z-L22</b>	11/16-12	-10	86,1	3.39	60,5	2.38	12,7	0.51	.25	0.69	17.5	

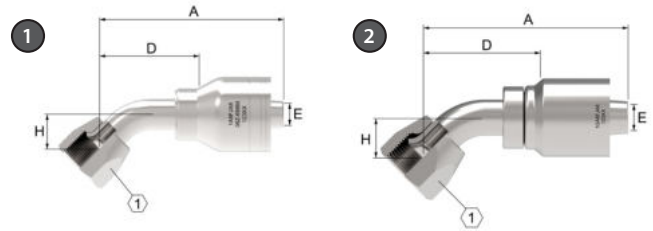

## JIC/37° Female Swivel 45° tube elbow

PART		HOSE SIZE INFO		DIMENSIONS								
1 Z part #	2 327E part #	Thd.	Hose size	A		D		EØ		H		1
		in		mm	in	mm	in	mm	in	mm	in	in
<b>04Z-684<sup>a</sup></b>		7/16-20	-04	49,8	1.96	24,6	0.97	3,8	0.15	8,4	0.33	9/16
<b>04Z-685<sup>a</sup></b>		1/2-20	-04	51,8	2.04	28,4	1.12	4,3	0.17	9,4	0.37	5/8
<b>04Z-686</b>		9/16-18	-04	53,1	2.09	29,7	1.17	4,3	0.17	9,9	0.39	11/16
<b>06Z-684<sup>a</sup></b>		7/16-20	-06	44,5	1.75	23,4	0.92	4,1	0.16	8,4	0.33	9/16
<b>06Z-686</b>		9/16-18	-06	58,7	2.31	33,3	1.31	6,1	0.24	9,9	0.39	11/16
<b>06Z-688<sup>a</sup></b>		3/4-16	-06	67,3	2.65	42,2	1.66	6,6	0.26	14,0	0.55	7/8
<b>08Z-688<sup>a</sup></b>		3/4-16	-08	71,6	2.82	41,9	1.65	9,4	0.37	14,0	0.55	7/8
<b>08Z-690<sup>a</sup></b>		7/8-14	-08	77,0	3.03	47,2	1.86	9,7	0.38	15,0	0.59	1
<b>10Z-690<sup>a</sup></b>	<b>32710E-690</b>	7/8-14	-10	74,7	2.94	45,5	1.79	11,7	0.46	15,0	0.59	1
<b>10Z-692</b>		11/16-12	-10	85,9	3.38	56,4	2.22	12,7	0.50	19,8	0.78	11/4
<b>12Z-696</b>		15/16-12	-12	87,1	3.43	60,2	2.37	15,5	0.61	26,9	1.06	11/2
<b>12Z-692</b>		11/16-12	-12	87,1	3.43	56,9	2.24	14,7	0.58	19,8	0.78	11/4
<b>16Z-696</b>		15/16-12	-16	95,0	3.74	60,7	2.39	19,3	0.76	27,2	1.07	11/2
<b>20Z-697</b>		15/8-12	-20	112,8	4.44	68,8	2.71	25,7	1.01	31,0	1.22	2

<sup>a</sup> Swivel nuts are universal – both SAE 37° and 45° connections.

# Weatherhead

Braided series

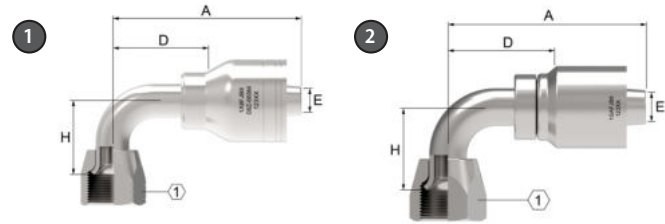

## JIC/37° Female Swivel 90° elbow

PART		HOSE SIZE INFO		DIMENSIONS								
1 Z part #	2 327E part #	Thd.	Hose size	A		D		EØ		H		1
		in		mm	in	mm	in	mm	in	mm	in	in
<b>04Z-664<sup>a</sup></b>		7/16-20	-04	46,7	1.84	23,3	0.92	3,8	0.15	17,3	0.68	9/16
<b>04Z-665<sup>a</sup></b>		1/2-20	-04	48,8	1.92	25,4	1.00	4,3	0.17	19,3	0.76	5/8
<b>04Z-666</b>		9/16-18	-04	50,8	2.00	25,1	0.99	4,3	0.17	21,3	0.84	11/16
<b>06Z-664<sup>a</sup></b>		7/16-20	-06	46,0	1.81	24,9	0.98	4,1	0.16	17,3	0.68	9/16
<b>06Z-666</b>	<b>32706E-666</b>	9/16-18	-06	56,1	2.21	31,0	1.22	6,1	0.24	21,3	0.84	11/16
<b>06Z-668<sup>a</sup></b>		3/4-16	-06	61,5	2.42	36,1	1.42	6,6	0.26	27,7	1.09	7/8
<b>08Z-666</b>		9/16-18	-08	61,7	2.43	32,0	1.26	6,1	0.24	21,3	0.84	11/16
<b>08Z-668<sup>a</sup></b>		3/4-16	-08	65,8	2.59	36,1	1.42	9,4	0.37	27,7	1.09	7/8
<b>08Z-670<sup>a</sup></b>		7/8-14	-08	70,6	2.78	41,0	1.61	9,7	0.38	30,2	1.19	1
<b>10Z-670<sup>a</sup></b>	<b>32710E-670</b>	7/8-14	-10	68,6	2.70	39,4	1.55	11,4	0.45	30,2	1.19	1
<b>10Z-672</b>		11/16-12	-10	84,1	3.31	54,9	2.16	12,7	0.50	45,7	1.80	11/4
<b>12Z-670<sup>a</sup></b>		7/8-14	-12	65,3	2.57	39,6	1.56	11,7	0.46	30,2	1.19	1
<b>12Z-672</b>	<b>32712E-672</b>	11/16-12	-12	85,4	3.36	55,1	2.17	17,4	0.58	45,7	1.80	11/4
<b>12Z-676</b>		15/16-12	-12	85,6	3.37	55,4	2.18	15,5	0.61	60,7	2.39	11/2
<b>16Z-676</b>		15/16-12	-16	90,4	3.56	55,9	2.20	19,3	0.76	60,7	2.39	11/2
<b>16Z-677</b>		15/8-12	-16	95,8	3.77	62,2	2.45	20,8	0.82	69,9	2.75	2
<b>20Z-677</b>		15/8-12	-20	108,0	4.25	64,0	2.52	25,7	1.01	69,9	2.75	2
<b>24Z-678</b>		17/8-12	-24	117,6	4.63	71,4	2.81	32,0	1.26	80,5	3.17	21/4

<sup>a</sup> Swivel nuts are universal – both SAE 37° and 45° connections.

Braided series

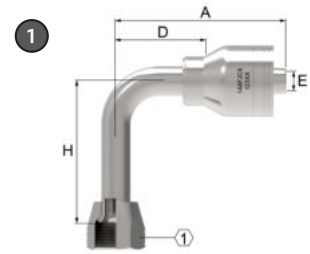

## JIC/37° Female Swivel 90° long drop tube elbow

PART	HOSE SIZE INFO		DIMENSIONS								
	Z part #	Thd.	Hose size	A		D		EØ		H	
	in		mm	in	mm	in	mm	in	mm	in	in
<b>04Z-644<sup>a</sup></b>	7/16-20	-04	46,7	1.84	23,3	0.92	3,8	0.15	45,7	1.80	9/16
<b>04Z-645<sup>a</sup></b>	1/2-20	-04	48,8	1.92	25,4	1.00	4,3	0.17	45,7	1.80	5/8
<b>06Z-644<sup>a</sup></b>	7/16-20	-06	46,0	1.81	24,9	0.98	4,3	0.17	45,7	1.80	9/16
<b>06Z-646</b>	9/16-18	-06	56,4	2.22	31,2	1.23	6,1	0.24	55,4	2.18	11/16
<b>06Z-648<sup>a</sup></b>	3/4-16	-06	64,5	2.54	39,1	1.54	6,6	0.26	62,2	2.45	7/8
<b>08Z-648<sup>a</sup></b>	3/4-16	-08	68,8	2.71	39,1	1.54	9,4	0.37	62,2	2.45	7/8
<b>08Z-650<sup>a</sup></b>	7/8-14	-08	70,6	2.78	40,9	1.61	9,7	0.38	65,3	2.57	1
<b>10Z-650<sup>a</sup></b>	7/8-14	-10	68,6	2.70	39,1	1.54	11,7	0.46	65,3	2.57	1
<b>12Z-652 *</b>	11/16-12	-12	85,3	3.36	55,1	2.17	14,7	0.58	94,0	3.70	11/4
<b>16Z-656 **</b>	15/16-12	-16	90,4	3.56	55,9	2.20	19,3	0.76	116,3	4.58	11/2
<b>20Z-657</b>	15/8-12	-20	108,0	4.25	64,0	2.52	25,7	1.01	140,5	5.53	2

<sup>a</sup> Swivel nuts are universal – both SAE 37° and 45° connections.

\* The 90° long drop tube elbow configuration meets a 3.5:1 burst, based on 4000psi operating pressure.

\*\*The 90° long drop tube elbow configuration meets a 3.7:1 burst, based on 3000psi operating pressure.

# Weatherhead

Braided series

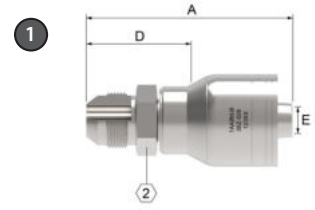

## JIC/37° male rigid

PART	HOSE SIZE INFO		DIMENSIONS						
	Thd.	Hose size	A		D		EØ		2
1 Z part #	in		mm	in	mm	in	mm	in	in
04Z-504	7/16-20	-04	50,8	2.00	27,2	1.07	4,3	0.17	9/16
04Z-505	1/2-20	-04	46,7	1.84	23,4	0.92	4,3	0.17	9/16
04Z-506	9/16-18	-04	47,0	1.85	23,6	0.93	4,3	0.17	5/8
06Z-506	9/16-18	-06	54,9	2.16	29,7	1.17	6,6	0.26	11/16
06Z-508	3/4-16	-06	53,3	2.10	28,2	1.11	6,6	0.26	13/16
06Z-510	7/8-14	-06	53,3	2.10	30,7	1.21	6,6	0.26	15/16
08Z-508	3/4-16	-08	65,3	2.57	35,8	1.41	9,7	0.38	13/16
08Z-510	7/8-14	-08	61,5	2.42	32,0	1.26	9,7	0.38	15/16
08Z-512	11/16-12	-08	65,8	2.59	36,1	1.42	9,7	0.38	11/8
10Z-508	3/4-16	-10	61,7	2.43	35,8	1.41	12,7	0.50	15/16
10Z-510	7/8-14	-10	69,3	2.73	39,9	1.57	12,2	0.48	15/16
10Z-512	11/16-12	-10	65,8	2.59	36,3	1.43	12,7	0.50	11/8
12Z-510	7/8-14	-12	70,6	2.78	40,4	1.59	12,2	0.48	11/8
12Z-512	11/16-12	-12	74,7	2.94	44,5	1.75	15,5	0.61	11/8
12Z-514	13/16-12	-12	69,3	2.73	39,1	1.54	15,5	0.61	11/4
12Z-516	15/16-12	-12	69,9	2.75	39,6	1.56	15,5	0.61	13/8
16Z-514	1 3/16-12	-16	79,0	3.11	45,7	1.80	18,3	0.72	13/8
16Z-516	15/16-12	-16	82,6	3.25	48,3	1.90	20,8	0.82	13/8
16Z-520	1 5/8-12	-16	77,0	3.03	43,4	1.71	20,6	0.81	1 11/16
20Z-520	1 5/8-12	-20	98,8	3.89	54,9	2.16	26,7	1.05	1 3/4
24Z-524	1 7/8-12	-24	109,5	4.31	63,2	2.49	32,0	1.26	2

Braided series

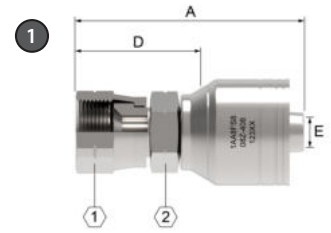

## SAE 45° female swivel

PART	HOSE SIZE INFO		DIMENSIONS							
	Z part #	Thd.	Hose size	A		D		EØ		1
	in		mm	in	mm	in	mm	in	in	in
<b>04Z-404</b>	7/16-20	-04	50,8	2.00	27,2	1.07	4,3	0.17	9/16	9/16
<b>06Z-404</b>	7/16-20	-06	55,6	2.19	30,2	1.19	4,8	0.19	9/16	11/16
<b>06Z-406</b>	5/8-18	-06	58,7	2.31	33,3	1.31	6,6	0.26	3/4	11/16
<b>06Z-408</b>	3/4-16	-06	58,7	2.31	33,3	1.31	6,6	0.26	7/8	11/16
<b>08Z-408</b>	3/4-16	-08	66,8	2.63	37,1	1.46	9,7	0.38	7/8	13/16
<b>08Z-410</b>	7/8-14	-08	67,1	2.64	37,3	1.47	9,7	0.38	1	13/16
<b>12Z-412</b>	11/16-14	-12	72,1	2.84	41,9	1.65	15,5	0.61	11/4	11/8

# Weatherhead

Braided series

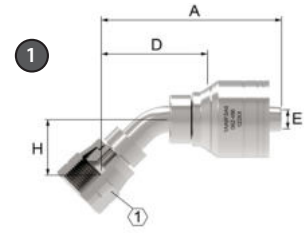

## SAE 45° female swivel 45° tube elbow

PART	HOSE SIZE INFO		DIMENSIONS								
	Z part #	Thd.	Hose size	A		D		E		①	H
	in		mm	in	mm	in	mm	in	in	mm	in
<b>06Z-486</b>	5/8-18	-06	58,2	2.29	36,8	1.45	6,1	0.24	.75	18.5	.73



Braided series

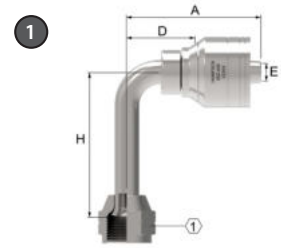

## SAE 45° female swivel long drop 90° tube elbow

PART	HOSE SIZE INFO		DIMENSIONS							
	Z part #	Thd.	Hose size	A		D		EØ		1
	in		mm	in	mm	in	mm	in	in	in
<b>06Z-446</b>	5/8-18	-06	47,5	1.87	26,2	1.03	6.1	0.24	3/4	2.18

**Weatherhead**

Braided series

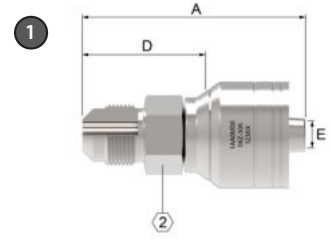
**SAE 45° flare male rigid**

PART Z part #	HOSE SIZE INFO		DIMENSIONS						
	Thd.	Hose size	A		D		EØ		2
	in		mm	in	mm	in	mm	in	in
<b>06Z-306</b>	5/8-18	-06	52,3	2.06	31,2	1.23	6,6	0.26	11/16
<b>12Z-312</b>	11/16-14	-12	74,7	2.94	47,8	1.88	15,5	0.61	11/8

Braided series

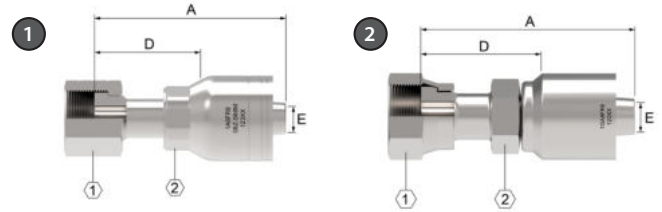

## Female ORS swivel

PART		HOSE SIZE INFO		DIMENSIONS							
1 Z part #	2 327E part #	Thd.	Hose size	A		D		EØ		1	2
		in		mm	in	mm	in	mm	in	in	in
<b>04Z-S64</b>		9/16-18	-04	49,5	1.95	26,1	1.03	4,3	0.17	11/16	9/16
<b>04Z-S66</b>		11/16-16	-04	51,8	2.04	28,4	1.12	4,3	0.17	13/16	5/8
<b>04Z-S68</b>		13/16-16	-04	52,3	2.06	32,5	1.28	4,1	0.16	13/16	15/16
<b>06Z-S64</b>		9/16-18	-06	54,4	2.14	29,2	1.15	4,3	0.17	11/16	11/16
<b>06Z-S66</b>	<b>32706E-S66</b>	11/16-16	-06	56,6	2.23	31,5	1.24	6,6	0.26	13/16	11/16
<b>06Z-S68</b>		13/16-16	-06	58,9	2.32	33,5	1.32	6,6	0.26	15/16	13/16
<b>08Z-S66</b>		11/16-16	-08	63,8	2.51	34,0	1.34	6,6	0.26	13/16	7/8
<b>08Z-S68</b>	<b>32708E-S68</b>	13/16-16	-08	67,8	2.67	38,1	1.50	9,7	0.38	15/16	7/8
<b>08Z-S70</b>		1-14	-08	67,1	2.64	37,3	1.47	9,7	0.38	11/8	15/16
<b>08Z-S72</b>		13/16-12	-08	71,1	2.80	41,4	1.63	9,7	0.38	13/8	11/8
<b>10Z-S68</b>		13/16-16	-10	67,8	2.67	38,4	1.51	9,7	0.38	15/16	15/16
<b>10Z-S70</b>	<b>32710E-S70</b>	1-14	-10	70,1	2.76	40,9	1.61	12,2	0.48	11/8	15/16
<b>10Z-S72</b>		13/16-12	-10	70,9	2.79	41,4	1.63	12,7	0.50	13/8	11/8
<b>12Z-S70</b>		1-14	-12	71,4	2.81	41,4	1.62	12,2	0.48	11/8	11/8
<b>12Z-S72</b>	<b>32712E-S72</b>	13/16-12	-12	73,9	2.91	43,7	1.72	15,5	0.61	13/8	11/8
<b>12Z-S76</b>		17/16-12	-12	75,7	2.98	45,5	1.79	15,5	0.61	15/8	13/8
<b>16Z-S72</b>		13/16-12	-16	81,8	3.22	47,2	1.86	15,5	0.61	13/8	13/8
<b>16Z-S76</b>		17/16-12	-16	83,6	3.29	49,3	1.94	20,6	0.81	15/8	13/8
<b>16Z-S80</b>		111/16-12	-16	82,6	3.25	48,3	1.90	20,6	0.81	17/8	15/8
<b>20Z-S80</b>		111/16-12	-20	98,8	3.89	59,2	2.33	25,9	1.02	17/8	13/4
<b>20Z-S84</b>		2-12	-20	94,6	3.88	54,6	2.15	26,7	1.05	21/4	113/16
<b>24Z-S84</b>		2-12	-24	102,1	4.02	55,6	2.19	32,0	1.26	21/4	2

# Weatherhead

Braided series

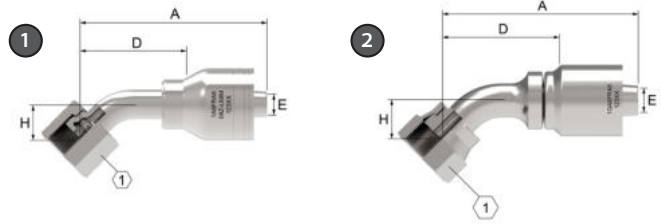

## Female ORS swivel 45° tube elbow

PART		HOSE SIZE INFO		DIMENSIONS								
1 Z part #	2 327E part #	Thd.	Hose size	A		D		EØ		H		1
		in		mm	in	mm	in	mm	in	mm	in	in
<b>04Z-L64</b>		9/16-18	-04	53,8	2.12	30,4	1.20	4,3	0.17	10,2	0.40	11/16
<b>04Z-L66</b>		11/16-16	-04	58,4	2.30	35,1	1.38	4,3	0.17	10,9	0.43	13/16
<b>06Z-L64</b>		9/16-18	-06	58,4	2.30	33,0	1.30	4,3	0.17	10,4	0.41	11/16
<b>06Z-L66</b>	<b>32706E-L66</b>	11/16-16	-06	61,7	2.43	36,3	1.43	6,6	0.26	10,9	0.43	13/16
<b>06Z-L68</b>		13/16-16	-06	69,6	2.74	44,2	1.74	6,6	0.26	15,0	0.59	15/16
<b>08Z-L66</b>		11/16-16	-08	67,3	2.65	37,6	1.48	6,6	0.26	10,9	0.43	13/16
<b>08Z-L68</b>	<b>32708E-L68</b>	13/16-16	-08	75,2	2.96	45,5	1.79	9,1	0.36	15,0	0.59	15/16
<b>08Z-L70</b>		1-14	-08	80,8	3.18	51,1	2.01	9,7	0.38	16,5	0.65	11/8
<b>08Z-L72</b>		13/16-12	-08	89,2	3.51	59,4	2.34	9,7	0.38	21,1	0.83	13/8
<b>10Z-L70</b>		1-14	-10	77,5	3.05	51,1	2.01	11,4	0.45	16,5	0.65	11/8
<b>10Z-L72</b>		13/16-12	-10	89,4	3.52	59,9	2.36	12,7	0.50	21,1	0.83	13/8
<b>12Z-L70</b>		1-14	-12	78,5	3.09	51,8	2.04	11,4	0.45	16,5	0.65	11/8
<b>12Z-L72</b>	<b>32712E-L72</b>	13/16-12	-12	90,7	3.57	60,5	2.38	14,0	0.55	21,1	0.83	13/8
<b>12Z-L76</b>		17/16-12	-12	102,6	4.04	72,4	2.85	15,5	0.61	23,9	0.94	15/8
<b>16Z-L72</b>		13/16-12	-16	94,5	3.72	60,9	2.40	14,0	0.55	21,1	0.83	13/8
<b>16Z-L76</b>		17/16-12	-16	107,4	4.23	73,2	2.88	19,8	0.78	23,9	0.94	15/8
<b>16Z-L80</b>		111/16-12	-16	117,3	4.62	83,8	3.30	20,7	0.81	25,4	1.00	17/8
<b>20Z-L80</b>		111/16-12	-20	129,5	5.10	85,6	3.37	25,9	1.02	25,4	1.00	17/8
<b>20Z-L84</b>		2-12	-20	139,4	5.49	95,5	3.76	25,7	1.01	27,2	1.07	21/4
<b>24Z-L84</b>		2-12	-24	115,3	4.54	68,8	2.71	32,0	1.26	27,2	1.07	21/4

Braided series

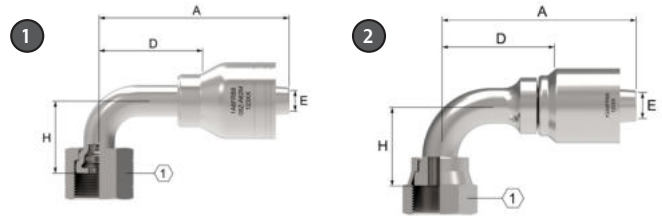

## Female ORS swivel short drop 90° tube elbow

PART		HOSE SIZE INFO		DIMENSIONS								
1 Z part #	2 327E part #	Thd.	Hose size	A		D		EØ		H		1
		in		mm	in	mm	in	mm	in	mm	in	in
<b>04Z-A24</b>		9/16-18	-04	53,1	2.09	29,7	1.17	4,3	0.17	20,8	0.82	11/16
<b>04Z-A26</b>		11/16-16	-04	56,4	2.22	33,0	1.30	4,3	0.17	22,9	0.90	13/16
<b>06Z-A24</b>		9/16-18	-06	56,1	2.21	30,7	1.21	4,3	0.17	20,8	0.82	11/16
<b>06Z-A26</b>	<b>32706E-A26</b>	11/16-16	-06	59,4	2.34	34,0	1.34	6,6	0.26	22,9	0.90	13/16
<b>06Z-A28</b>		13/16-16	-06	66,5	2.62	41,4	1.62	6,6	0.26	29,2	1.15	15/16
<b>08Z-A26</b>		11/16-16	-08	65,0	2.56	35,3	1.39	6,6	0.26	22,9	0.90	13/16
<b>08Z-A28</b>	<b>32708E-A28</b>	13/16-16	-08	72,1	2.84	42,4	1.67	9,1	0.36	29,2	1.15	15/16
<b>08Z-A30</b>		1-14	-08	78,0	3.07	48,5	1.91	9,7	0.38	32,3	1.27	1 1/8
<b>08Z-A32</b>		13/16-12	-08	87,6	3.45	57,9	2.28	9,7	0.38	47,8	1.88	1 3/8
<b>10Z-A30</b>		1-14	-10	78,0	3.07	48,5	1.91	11,4	0.45	32,3	1.27	1 1/8
<b>10Z-A32</b>		1 3/16-12	-10	87,4	3.44	58,2	2.29	12,7	0.50	47,8	1.88	1 3/8
<b>12Z-A30</b>		1-14	-12	79,0	3.11	49,0	1.93	11,4	0.45	32,3	1.27	1 1/8
<b>12Z-A32</b>		1 3/16-12	-12	88,6	3.49	58,4	2.30	14,0	0.55	47,8	1.88	1 3/8
<b>12Z-A36</b>		1 7/16-12	-12	102,6	4.04	72,4	2.85	15,5	0.61	56,1	2.21	1 5/8
<b>16Z-A36</b>		1 7/16-12	-16	107,2	4.22	72,9	2.87	20,6	0.81	56,1	2.21	1 5/8
<b>16Z-A40</b>		1 11/16-12	-16	123,2	4.85	89,0	3.50	20,6	0.81	63,8	2.51	1 7/8
<b>20Z-A40</b>		1 11/16-12	-20	134,6	5.30	90,7	3.57	25,9	1.02	63,8	2.51	1 7/8
<b>20Z-A44</b>		2-12	-20	109,7	4.32	70,4	2.77	26,6	1.05	68,6	2.70	2 1/4
<b>24Z-A40</b>		1 11/16-12	-24	117,6	4.63	71,4	2.81	32,0	1.26	68,6	2.70	2 1/4
<b>24Z-A44</b>		2-12	-24	117,6	4.63	71,4	2.81	32,0	1.26	68,6	2.70	2 1/4

# Weatherhead

Braided series

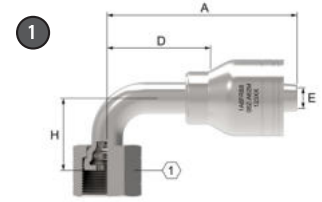

## Female ORS swivel medium drop 90° tube elbow

PART	HOSE SIZE INFO		DIMENSIONS							
	Thd.	Hose size	A		D		EØ		1	H
1 Z part #	in		mm	in	mm	in	mm	in	mm	in
04Z-J34	9/16-18	-04	49,5	1.95	29,7	1.17	4,3	0.17	11/16	1.26
04Z-J36	11/16-16	-04	55,1	2.17	32,8	1.29	4,3	0.17	13/16	1.51
04Z-J38	13/16-16	-04	55,9	2.20	35,8	1.41	4,3	0.17	15/16	1.67
06Z-J36	11/16-16	-06	55,1	2.17	34,0	1.34	6,6	0.26	13/16	1.51
06Z-J38	13/16-16	-06	57,4	2.26	36,1	1.42	6,6	0.26	15/16	1.67
08Z-J36	11/16-16	-08	63,0	2.48	37,6	1.48	6,1	0.24	13/16	1.51
08Z-J38	13/16-16	-08	67,6	2.66	42,4	1.67	9,1	0.36	15/16	1.62
08Z-J42	13/16-12	-08	98,3	3.87	72,9	2.87	9,7	0.38	13/8	2.13
10Z-J40	1-14	-10	74,4	2.93	48,5	1.91	11,4	0.45	11/8	1.85
12Z-J40	1-14	-12	67,6	2.66	40,6	1.60	11,4	0.45	11/8	1.78
12Z-J42	13/16-12	-12	85,3	3.36	58,4	2.30	13,9	0.55	13/8	2.28
16Z-J46	17/16-12	-16	106,2	4.18	72,6	2.86	19,8	0.78	15/8	2.78
16Z-J50	111/16-12	-16	141,2	5.56	107,7	4.24	20,6	0.81	17/8	3.06
20Z-J50	111/16-12	-20	148,8	5.86	109,5	4.31	23,6	0.93	17/8	3.06

Braided series

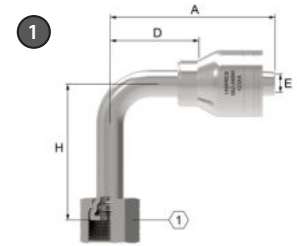

## Female ORS swivel long drop 90° tube elbow

PART		HOSE SIZE INFO		DIMENSIONS								
① Z part #	Thd.	Hose size	A		D		EØ		H		①	
			mm	in	mm	in	mm	in	mm	in		in
<b>04Z-A64</b>	9/16-18	-04	53,1	2.09	23,3	0.92	4,3	0.17	45,7	1.80	11/16	
<b>04Z-A66</b>	11/16-16	-04	56,4	2.22	33,0	1.30	4,3	0.17	54,1	2.13	13/16	
<b>04Z-A68</b>	13/16-16	-04	65,8	2.59	42,4	1.67	4,3	0.17	64,8	2.55	15/16	
<b>06Z-A66</b>	11/16-16	-06	59,4	2.34	34,0	1.34	6,1	0.24	54,1	2.13	13/16	
<b>06Z-A68</b>	13/16-16	-06	68,8	2.71	43,4	1.71	6,6	0.26	64,8	2.55	15/16	
<b>08Z-A68</b>	13/16-16	-08	72,9	2.87	43,2	1.70	9,4	0.37	64,8	2.55	15/16	
<b>08Z-A70</b>	1-14	-08	78,0	3.07	48,5	1.91	9,7	0.38	70,1	2.76	11/8	
<b>10Z-A70</b>	1-14	-10	78,0	3.07	48,5	1.91	11,7	0.46	70,1	2.76	11/8	
<b>12Z-A72 *</b>	13/16-12	-12	88,4	3.48	58,2	2.29	14,2	0.56	96,0	3.78	13/8	
<b>12Z-A76</b>	17/16-12	-12	102,6	4.04	72,4	2.85	15,5	0.61	114,3	4.50	15/8	
<b>16Z-A76**</b>	17/16-12	-16	107,2	4.22	72,6	2.86	19,8	0.78	114,3	4.50	15/8	
<b>20Z-A80</b>	111/16-12	-20	134,6	5.30	90,7	3.57	25,7	1.01	129,3	5.09	17/8	
<b>20Z-A84</b>	2-12	-20	109,7	4.32	70,4	2.77	26,7	1.05	140,7	5.54	21/4	
<b>24Z-A84</b>	2-12	-24	117,6	4.63	71,4	2.81	32,0	1.26	140,7	5.54	21/4	

\* The 90° long drop tube elbow configuration meets a 3.5:1 burst, based on 4000psi operating pressure.  
 \*\*The 90° long drop tube elbow configuration meets a 3.7:1 burst, based on 3000psi operating pressure.



**Weatherhead**

Braided series

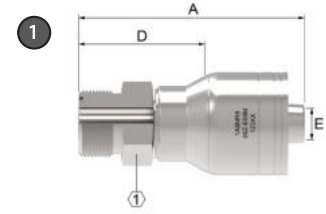
**ORS male rigid**

PART ① Z part #	HOSE SIZE INFO		DIMENSIONS						
	Thd.	Hose size	A		D		EØ		① mm
	in		mm	in	mm	in	mm	in	mm
<b>04Z-E64</b>	9/16-18	-04	45,2	1.78	21,8	0.86	4,3	0.17	5/8
<b>06Z-E66</b>	11/16-16	-06	50,5	1.99	25,1	0.99	6,6	0.26	3/4
<b>06Z-E68</b>	13/16-16	-06	49,5	1.95	24,1	0.95	6,6	0.26	7/8
<b>08Z-E68</b>	13/16-16	-08	58,4	2.30	28,7	1.13	9,7	0.38	7/8
<b>08Z-E70</b>	1-14	-08	55,1	2.17	29,7	1.17	9,7	0.38	11/16
<b>08Z-E72</b>	13/16-12	-08	57,7	2.27	32,3	1.27	9,7	0.38	11/4
<b>10Z-E70</b>	1-14	-10	57,4	2.26	31,5	1.24	12,2	0.48	11/16
<b>10Z-E72</b>	13/16-12	-10	57,4	2.26	31,5	1.24	12,7	0.50	11/4
<b>12Z-E72</b>	13/16-12	-12	66,8	2.63	36,6	1.44	15,5	0.61	11/4
<b>12Z-E76</b>	17/16-12	-12	64,3	2.53	34,0	1.34	15,5	0.61	11/2
<b>16Z-E76</b>	17/16-12	-16	75,2	2.96	41,7	1.64	20,7	0.81	11/2
<b>20Z-E80</b>	111/16-12	-20	85,1	3.35	45,7	1.80	26,2	1.03	13/4

Does not include O-ring. See page 231 O-ring part number.

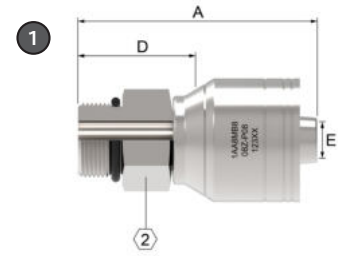

## Male straight thread O-ring rigid

PART 1 Z part #	HOSE SIZE INFO		DIMENSIONS						
	Thd.	Hose size	A		D		EØ		1
	in		mm	in	mm	in	mm	in	in
<b>04Z-P04</b>	7/16-20	-04	46,7	1.84	23,4	0.92	4,3	0.17	9/16
<b>04Z-P05</b>	1/2-20	-04	46,7	1.84	23,4	0.92	4,3	0.17	5/8
<b>04Z-P06</b>	9/16-18	-04	45,2	1.78	21,8	0.86	4,3	0.17	11/16
<b>06Z-P06</b>	9/16-18	-06	50,8	2.00	25,4	1.00	6,6	0.26	11/16
<b>06Z-P08</b>	3/4-16	-06	50,0	1.97	24,9	0.98	6,6	0.26	7/8
<b>06Z-P10</b>	7/8-14	-06	47,8	1.88	26,7	1.05	6,6	0.26	1
<b>08Z-P08</b>	3/4-16	-08	59,9	2.36	30,2	1.19	9,7	0.38	7/8
<b>08Z-P10</b>	7/8-14	-08	57,4	2.26	27,7	1.09	9,7	0.38	1
<b>08Z-P12</b>	11/16-12	-08	60,7	2.39	31,0	1.22	9,7	0.38	11/4
<b>10Z-P08</b>	3/4-16	-10	56,1	2.21	30,2	1.19	12,7	0.50	15/16
<b>10Z-P10</b>	7/8-14	-10	59,4	2.34	33,5	1.32	12,7	0.50	1
<b>10Z-P12</b>	11/16-12	-10	60,7	2.39	31,2	1.23	12,7	0.50	11/4
<b>12Z-P10</b>	7/8-14	-12	64,3	2.53	37,1	1.46	12,2	0.48	11/8
<b>12Z-P12</b>	11/16-12	-12	62,0	2.44	31,8	1.25	15,5	0.61	11/4
<b>12Z-P16</b>	15/16-12	-12	65,0	2.56	34,8	1.37	15,5	0.61	11/2
<b>16Z-P16</b>	15/16-12	-16	69,6	2.74	35,3	1.39	20,8	0.82	11/2
<b>20Z-P20</b>	15/8-12	-20	92,2	3.63	48,3	1.90	26,7	1.05	17/8
<b>24Z-P24</b>	17/8-12	-24	92,2	3.63	46,0	1.81	32,0	1.26	21/8

Does not include O-ring. See page 231 O-ring part number.

**Weatherhead**

Braided series

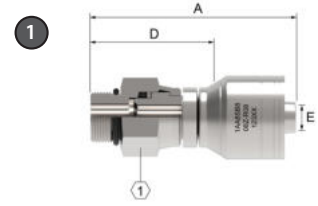
**Male straight thread O-ring swivel**

PART	HOSE SIZE INFO		DIMENSIONS						
	Z part #	Thd.	Hose size	A		D		EØ	
	in		mm	in	mm	in	mm	in	mm
<b>04Z-R04</b>	7/16-20	-04	64,0	2.52	40,3	1.59	4,3	0.17	3/4
<b>06Z-R06</b>	9/16-18	-06	69,1	2.72	43,9	1.73	6,6	0.26	7/8
<b>06Z-R08</b>	3/4-16	-08	67,6	2.66	42,4	1.67	6,6	0.26	7/8
<b>08Z-R08</b>	3/4-16	-08	76,5	3.01	46,7	1.84	9,6	0.38	1
<b>08Z-R10</b>	7/8-14	-08	77,0	3.03	47,2	1.86	9,6	0.38	1
<b>08Z-R12</b>	11/16-12	-08	88,6	3.49	58,9	2.32	9,6	0.38	17/16
<b>10Z-R08</b>	3/4-16	-10	76,7	3.02	47,2	1.86	12,7	0.50	1
<b>12Z-R10</b>	7/8-14	-12	87,1	3.43	56,9	2.24	15,5	0.61	17/16

Does not include O-ring. See page 231 O-ring part number.

Braided series

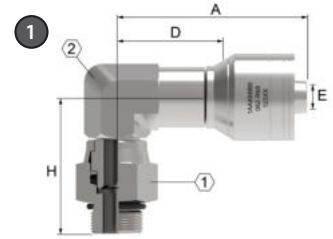

## Male straight thread O-ring swivel 90° elbow

PART	HOSE SIZE INFO		DIMENSIONS								
	Z part #	Thd.	Hose size	A		D		EØ		1	2
	in		mm	in	mm	in	mm	in	in	in	in
<b>04Z-R66</b>	9/16-18	-04	55,4	2.18	32,0	1.26	4,3	0.17	7/8	3/4	1,87
<b>06Z-R66</b>	9/16-18	-06	59,2	2.33	33,7	1.33	6,6	0.26	7/8	3/4	1,87
<b>06Z-R68</b>	3/4-16	-06	59,2	2.33	33,7	1.33	6,6	0.26	1	3/4	1,93
<b>06Z-R70</b>	7/8-14	-06	59,2	2.33	33,7	1.33	6,6	0.26	1	3/4	1,95
<b>08Z-R68</b>	3/4-16	-08	68,1	2.68	38,3	1.51	9,7	0.38	1	3/4	1,93
<b>08Z-R70</b>	7/8-14	-08	68,1	2.68	38,3	1.51	9,7	0.38	1	3/4	1,97
<b>08Z-R72</b>	11/16-12	-08	79,2	3.12	49,5	1.95	9,7	0.38	17/16	11/16	2,43
<b>12Z-R72</b>	11/16-12	-12	94,5	3.72	64,2	2.53	15,5	0.61	17/16	32 mm	2,65

Does not include O-ring. See page 231 O-ring part number.

# Weatherhead

Braided series

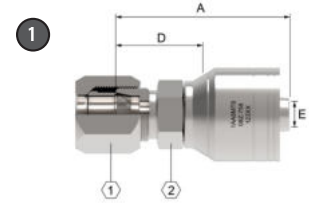

## Flareless tube rigid Ermeto 7000 series (with nuts and sleeve)

PART ① Z part #	HOSE SIZE INFO			DIMENSIONS							
	Thd.	Tube O.D.	Hose size	A		D		EØ		①	②
	in	in		mm	in	mm	in	mm	in	in	in
<b>04Z-754</b>	7/16-20	1/4	-04	41,9	1.65	21,8	0.86	4,3	0.17	9/16	9/16
<b>04Z-755</b>	1/2-20	5/16	-04	40,1	1.58	20,3	0.80	4,3	0.17	5/8	5/8
<b>06Z-754</b>	7/16-20	1/4	-06	46,0	1.81	24,6	0.97	6,6	0.26	9/16	9/16
<b>06Z-755</b>	1/2-20	5/16	-06	46,0	1.81	24,6	0.97	5,8	0.23	5/8	5/8
<b>06Z-756</b>	9/16-18	3/8	-06	46,2	1.82	25,2	0.99	6,6	0.26	11/16	11/16
<b>08Z-758</b>	3/4-16	1/2	-08	54,6	2.15	29,5	1.16	9,7	0.38	7/8	7/8
<b>08Z-760</b>	7/8-14	5/8	-08	53,8	2.12	28,5	1.12	9,7	0.38	1	1
<b>12Z-762</b>	1 1/16-12	3/4	-12	61,0	2.40	34,0	1.34	15,5	0.61	1 1/4	1 1/4
<b>16Z_766</b>	1 5/16-12	1	-16	96,5	3.80	37,6	1.48	20,6	0.81	1 1/2	1 1/2
<b>20Z-770</b>	1 5/8-12	1 1/4	-20	85,1	3.35	45,7	1.80	26,7	1.05	2	2

Braided series

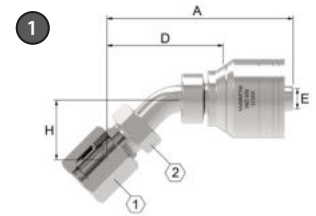

## Flareless 45° tube elbow 7000 Ermeto series

PART	HOSE SIZE INFO			DIMENSIONS									
	Z part #	Thd.	Tube O.D.	Hose size	A		D		EØ		1	2	H
	in	in			mm	in	mm	in	mm	in	in	in	in
<b>06Z-956</b>	9/16-18	3/8	-06		62,0	2.44	39,6	1.56	6,6	0.26	5/8	11/16	0.83

# Weatherhead

Braided series

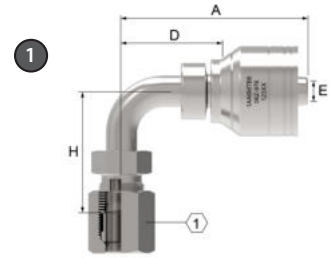

## Flareless 90° tube elbow 7000 Ermeto series (with nuts and sleeve)

PART	HOSE SIZE INFO			DIMENSIONS									
	Z part #	Thd.	Tube I.D.	Hose size	A		D		EØ		1	2	B
	in	in			mm	in	mm	in	mm	in	in	in	in
<b>06Z-976</b>	9/16-18	3/8	-06		52,1	2.05	30,9	1.22	6,6	0.26	11/16	5/8	1.46



Braided series

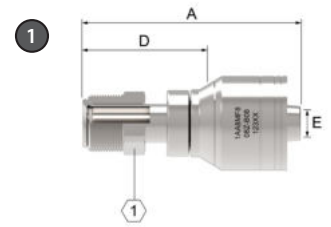

## Inverted male swivel straight

PART 1 Z part #	HOSE SIZE INFO		DIMENSIONS						
	Thd.	Hose size	A		D		EØ		1
	in		mm	in	mm	in	mm	in	in
<b>04Z-B03</b>	3/8-24	-04	76,2	3.00	55,9	2.20	2,5	0.10	3/8
<b>04Z-B04</b>	7/16-24	-04	60,7	2.39	37,1	1.46	4,3	0.17	7/16
<b>04Z-B05</b>	1/2-20	-04	60,7	2.39	37,1	1.46	4,3	0.17	1/2
<b>06Z-B04</b>	7/16-24	-06	64,3	2.53	38,9	1.53	4,3	0.17	7/16
<b>06Z-B05</b>	1/2-20	-06	66,0	2.60	40,9	1.61	6,1	0.24	1/2
<b>06Z-B06</b>	5/8-18	-06	66,0	2.60	40,9	1.61	6,6	0.26	5/8
<b>06Z-B07</b>	11/16-18	-06	62,2	2.45	40,6	1.60	6,6	0.26	11/16
<b>08Z-B08</b>	3/4-18	-08	70,9	2.79	41,4	1.62	9,7	0.38	3/4
<b>08Z-B10</b>	7/8-18	-08	74,7	2.94	49,0	1.93	9,7	0.38	7/8

Braided series

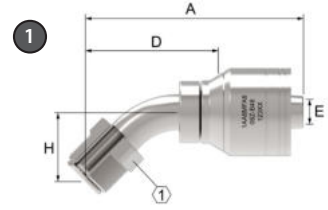

## Inverted male swivel 45° tube elbow

PART Z part #	HOSE SIZE INFO		DIMENSIONS								
	Thd.	Hose size	A		D		EØ		H		1
	in		mm	in	mm	in	mm	in	mm	in	mm
<b>04Z-B43</b>	3/8-24	-04	69,9	2.75	49,8	1.96	2,5	0.10	17,5	0.69	3/8
<b>04Z-B44</b>	7/16-24	-04	67,8	2.67	44,5	1.75	4,3	0.17	24,4	0.96	7/16
<b>04Z-B45</b>	1/2-20	-04	64,5	2.54	44,5	1.75	4,3	0.17	24,4	0.96	1/2
<b>06Z-B45</b>	1/2-20	-06	69,1	2.72	48,0	1.89	6,1	0.24	24,4	0.96	1/2
<b>06Z-B46</b>	5/8-18	-06	73,2	2.88	48,0	1.89	6,6	0.26	24,4	0.96	5/8
<b>06Z-B47</b>	11/16-18	-06	69,3	2.73	48,0	1.89	6,6	0.26	24,4	0.96	11/16
<b>08Z-B48</b>	3/4-18	-08	78,0	3.07	48,3	1.90	9,7	0.38	23,6	0.93	3/4

Braided series

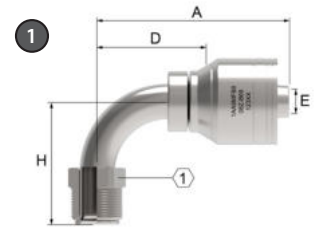

## Inverted male swivel 90° tube elbow

PART	HOSE SIZE INFO		DIMENSIONS								
	Z part #	Thd.	Hose size	A		D		EØ		H	
	in		mm	in	mm	in	mm	in	mm	in	in
<b>04Z-B63</b>	3/8-24	-04	53,8	2.12	33,5	1.32	2,5	0.10	27,9	1.06	3/8
<b>04Z-B64</b>	7/16-24	-04	58,2	2.29	34,8	1.37	4,3	0.17	42,3	1.69	7/16
<b>04Z-B65</b>	1/2-20	-04	55,1	2.17	34,8	1.37	4,3	0.17	43,9	1.73	1/2
<b>06Z-B64</b>	7/16-24	-06	57,8	2.28	36,6	1.44	4,3	0.17	42,3	1.69	7/16
<b>06Z-B65</b>	1/2-20	-06	63,8	2.51	38,4	1.51	6,1	0.24	43,9	1.73	1/2
<b>06Z-B66</b>	5/8-18	-06	63,8	2.51	38,4	1.51	6,6	0.26	43,9	1.73	5/8
<b>06Z-B67</b>	11/16-18	-06	62,0	2.44	40,9	1.61	6,6	0.26	43,9	1.73	11/16
<b>08Z-B68</b>	3/4-18	-08	69,3	2.73	39,6	1.56	9,7	0.38	44,5	1.75	3/4

Braided series

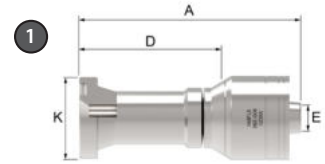

## Split flange straight (SAE Code 61)

PART 1 Z part #	HOSE SIZE INFO			DIMENSIONS							
	Nominal thread Size	Thd.	Hose size	A		D		EØ		K Flange head diameter	
	in	in		mm	in	mm	in	mm	in	mm	in
08Z-G08	1/2	1.19	-08	82,0	3.23	52,3	2.06	9,7	0.38	30.2	1.19
08Z-G12	3/4	1.50	-08	83,1	3.27	53,3	2.10	9,7	0.38	38.1	1.50
10Z-G12	3/4	1.50	-10	82,8	3.26	53,3	2.10	12,7	0.50	38.1	1.50
12Z-G12	3/4	1.50	-12	84,1	3.31	53,8	2.12	15,5	0.61	38.1	1.50
12Z-G16	1	1.75	-12	84,1	3.31	53,8	2.12	15,5	0.61	44.4	1.75
12Z-G20	1 1/4	2.00	-12	91,7	3.61	61,5	2.42	15,5	0.61	50.8	2.0
16Z-G16	1	1.75	-16	88,6	3.49	54,4	2.14	20,8	0.82	44.4	1.75
16Z-G20	1 1/4	2.00	-16	96,3	3.79	62,0	2.44	20,8	0.82	50.8	2.0
20Z-G16	1	1.75	-20	100,1	3.94	56,1	2.21	20,8	0.82	44.4	1.75
20Z-G20	1 1/4	2.00	-20	107,7	4.24	63,8	2.51	26,7	1.05	50.8	2.0
20Z-G24	1 1/2	2.38	-20	108,5	4.27	64,5	2.54	26,7	1.05	60.3	2.37
20Z-G32	2	2.81	-20	108,5	4.27	64,5	2.54	25,7	1.01	71.4	2.81
24Z-G24	1 1/2	2.38	-24	111,8	4.40	65,5	2.58	32,0	1.26	60.4	2.38
24Z-G32	2	2.81	-24	111,8	4.40	65,5	2.58	30,2	1.19	71.4	2.81
32Z-G32	2	2.81	-32	117,1	4.61	66,8	2.63	44,5	1.75	71.4	2.81
32Z-G33	2 1/2	3.31	-32	116,8	4.60	66,8	2.63	44,5	1.75	84.1	

See pages 228-230 for split flange kits.

Braided series

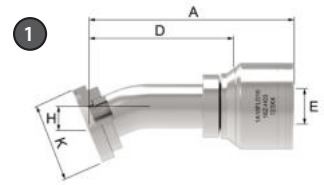

## Split Flange 22.5° tube elbow (SAE Code 61)

PART	HOSE SIZE INFO		DIMENSIONS									
	Z part #	Nominal flange size	Hose size	A		D		EØ		H		K Flange head diameter
	in		mm	in	mm	in	mm	in	mm	in	mm	in
<b>16Z-H03</b>	1	-16	117,9	4.64	83,6	3.29	19,3	0.76	11,4	0.45	44,4	1.75
<b>16Z-H04</b>	1 1/4	-16	130,0	5.12	95,8	3.77	19,3	0.76	11,7	0.46	50,8	2.00
<b>20Z-H04</b>	1 1/4	-20	141,5	5.57	97,3	3.83	25,7	1.01	11,7	0.46	50,8	2.00

See pages 228-230 for split flange kits.

# Weatherhead

Braided series

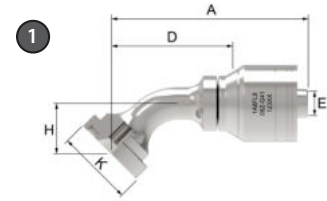

## Split Flange 45° tube elbow (SAE Code 61)

PART ① Z part #	HOSE SIZE INFO		DIMENSIONS									
	Nominal flange size	Hose size	A		D		EØ		H		K Flange head diameter	
	in		mm	in	mm	in	mm	in	mm	in	mm	in
08Z-G41	1/2	-08	79,0	3.11	49,3	1.94	9,4	0.37	19,8	0.78	30.2	1.19
08Z-G42	3/4	-08	92,5	3.64	62,7	2.47	9,4	0.37	25,4	1.00	38.1	1.50
10Z-G42	3/4	-10	93,5	3.68	64,3	2.53	11,7	0.46	25,4	1.00	38.1	1.50
12Z-G42	3/4	-12	93,2	3.67	63,0	2.48	14,7	0.58	25,7	1.01	38.1	1.50
12Z-G46	1	-12	105,7	4.16	75,4	2.97	14,7	0.58	26,9	1.06	44.4	1.75
16Z-G46	1	-16	110,5	4.35	76,2	3.00	19,3	0.76	26,9	1.06	44.4	1.75
16Z-G50	1 1/4	-16	122,2	4.81	87,6	3.45	19,3	0.76	29,2	1.15	50.8	2.00
20Z-G46	1	-20	121,9	4.80	77,7	3.06	19,3	0.76	26,9	1.06	44.4	1.75
20Z-G50	1 1/4	-20	134,1	5.28	90,2	3.55	25,7	1.01	30,0	1.18	50.8	2.00
20Z-G54	1 1/2	-20	146,2	5.76	106,7	4.20	25,7	1.01	35,8	1.41	60.3	2.37
24Z-G54	1 1/2	-24	151,6	5.97	107,0	4.25	32,0	1.26	35,8	1.41	60.3	2.37
24Z-G62	2	-24	154,2	6.07	108,0	4.25	32,0	1.26	35,8	1.41	71.4	2.81
32Z-G54	1 1/2	-32	159,3	6.27	109,0	4.29	32,0	1.26	35,8	1.41	60.3	2.37
32Z-G62	2	-32	190,2	7.49	140,2	5.52	44,5	1.75	50,8	2.00	71.4	2.81

See pages 228-230 for split flange kits.

Braided series

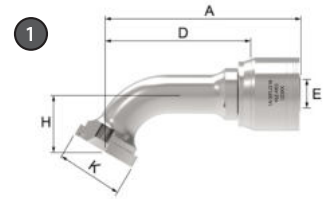

## Split Flange 60° tube elbow (SAE Code 61)

PART	HOSE SIZE INFO		DIMENSIONS									
	Z part #	Nominal flange size	Hose size	A		D		EØ		H		K Flange head diameter
	in		mm	in	mm	in	mm	in	mm	in	mm	in
<b>16Z-H53</b>	1	-16	132,5	5.22	98,7	3.89	19,9	0.78	38,3	1.51	44.4	1.75
<b>24Z-H55</b>	1-1/2	-24	187,1	7.37	143,4	5.65	32,0	1.26	46,1	1.81	60.3	2.37

See pages 228-230 for split flange kits.

**Weatherhead**

Braided series

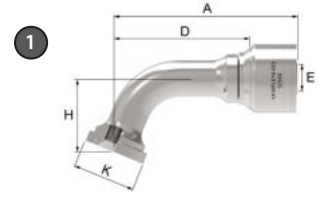
**Split Flange 67° tube elbow (SAE Code 61)**

PART Z part #	HOSE SIZE INFO		DIMENSIONS									
	Nominal flange size	Hose size	A		D		EØ		H		K Flange head diameter	
	in		mm	in	mm	in	mm	in	mm	in	mm	in
<b>20Z-H60</b>	1-1/4	-20	157,0	6.18	112,8	4.44	25,7	1.01	46,5	1.83	50.8	2.00
<b>20Z-H64</b>	1-1/2	-24	189,7	7.47	143,5	5.65	30,2	1.19	46,0	1.81	60.3	2.37

See pages 228-230 for split flange kits.



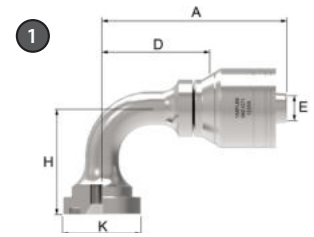

## Split Flange 90° tube elbow (SAE Code 61)

PART	HOSE SIZE INFO		DIMENSIONS									
	Z part #	Nominal flange size	Hose size	A		D		EØ		H		K Flange head diameter
	in		mm	in	mm	in	mm	in	mm	in	mm	in
<b>08Z-G71</b>	1/2	-08	72,6	2.86	42,3	1.69	9,4	0.37	41,4	1.63	30.2	1.19
<b>08Z-G72</b>	3/4	-08	87,6	3.45	57,9	2.28	9,4	0.37	54,1	2.13	38.1	1.50
<b>10Z-G72</b>	3/4	-10	87,4	3.44	58,2	2.29	12,7	0.50	54,1	2.13	38.1	1.50
<b>12Z-G72</b>	3/4	-12	88,6	3.49	58,4	2.30	14,7	0.58	54,1	2.13	38.1	1.50
<b>12Z-G76</b>	1	-12	102,4	4.03	72,1	2.84	14,7	0.58	60,5	2.38	44.4	1.75
<b>12Z-G80</b>	1 1/4	-12	118,6	4.67	88,4	3.48	14,7	0.58	66,5	2.62	50.8	2.00
<b>16Z-G76</b>	1	-16	107,2	4.22	72,6	2.86	19,3	0.76	60,5	2.38	44.4	1.75
<b>16Z-G80</b>	1 1/4	-16	123,2	4.85	89,0	3.50	19,3	0.76	66,5	2.62	50.8	2.00
<b>16Z-G84</b>	1 1/2	-16	142,0	5.59	107,7	4.24	19,3	0.76	79,2	3.12	60.3	2.37
<b>20Z-G76</b>	1	-20	118,4	4.66	74,4	2.93	19,3	0.76	60,5	2.38	44.4	1.75
<b>20Z-G80</b>	1 1/4	-20	134,6	5.30	90,7	3.57	25,7	1.01	66,5	2.62	50.8	2.00
<b>20Z-G84</b>	1 1/2	-20	153,4	6.04	109,4	4.31	26,6	1.05	79,3	3.12	60.3	2.37
<b>24Z-G80</b>	1 1/4	-24	137,9	5.43	91,7	3.61	25,7	1.01	66,5	2.62	50.8	2.00
<b>24Z-G84</b>	1 1/2	-24	157,0	6.18	110,5	4.35	32,0	1.26	79,3	3.12	60.3	2.37
<b>24Z-G92</b>	2	-24	184,9	7.28	138,4	5.45	32,0	1.26	114,3	4.50	71.4	2.81
<b>32Z-G92</b>	2	-32	182,9	7.20	119,9	4.72	41,4	1.62	114,3	4.50	71.4	2.81
<b>32Z-G93</b>	2 1/2	-32	182,9	7.20	119,9	4.72	41,4	1.62	115,8	4.56	84.1	3.31

See pages 228-230 for split flange kits.

**Weatherhead**

Braided series

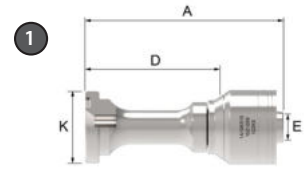
**Metric split flange straight** (Komatsu, Linkbelt, etc.)

PART Z part #	HOSE SIZE INFO		DIMENSIONS							
	Nominal flange size	Hose size	A		D		EØ		K Flange head diameter	
	in		mm	in	mm	in	mm	in	mm	in
<b>10Z-G09</b>	5/8	-10	94,2	0.16	64,8	2.55	11,5	0.45	34,2	1.35

See pages 228-230 for split flange kits.

Braided series

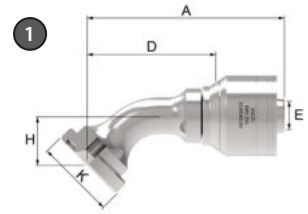

## Metric split flange 45° tube elbow (Komatsu, Linkbelt, etc.)

PART	HOSE SIZE INFO		DIMENSIONS										
	Z part #	Nominal flange size	Hose size	A		D		EØ		H		K Flange head diameter	
		in		mm	in	mm	in	mm	in	mm	in	mm	in
<b>10Z-G69</b>		5/8	-10	86,1	3.39	56,7	2.23	11,5	0.45	21,8	0.86	34,2	1.35

See pages 228-230 for split flange kits.

**Weatherhead**

Braided series

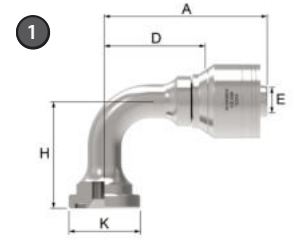
**Metric split flange 90° tube elbow** (Komatsu, Linkbelt, etc.)

PART Z part #	HOSE SIZE INFO		DIMENSIONS									
	Nominal flange size	Hose size	A		D		EØ		H		K Flange head diameter	
	in		mm	in	mm	in	mm	in	mm	in	mm	in
<b>10Z-G99</b>	5/8	-10	74,6	2.94	48,5	1.91	11,5	0.45	51,3	2.02	34,2	1.35

See pages 228-230 for split flange kits.

Braided series

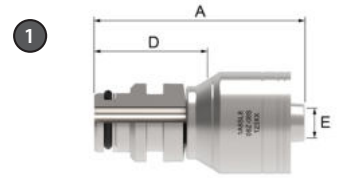

## READY-LOK® male connector (O-ring and backup ring included)

PART 1 Z part #	HOSE SIZE INFO		DIMENSIONS					
	Connector size	Hose size	A		D		EØ	
	in		mm	in	mm	in	mm	in
<b>04Z-04S</b>	1/4	-04	55,4	2.18	32,0	1.26	4,3	0.17
<b>06Z-06S</b>	3/8	-06	58,4	2.30	33,0	1.30	6,6	0.26
<b>06Z-08S</b>	1/2	-06	58,4	2.30	33,0	1.30	6,6	0.26
<b>08Z-08S</b>	1/2	-08	64,0	2.52	34,3	1.35	9,7	0.38
<b>12Z-12S</b>	3/4	-12	65,0	2.56	34,8	1.37	15,5	0.61
<b>16Z-16S</b>	1	-16	74,9	2.95	40,6	1.60	20,6	0.81

(O-ring and backup ring included.)

# Weatherhead

Braided series

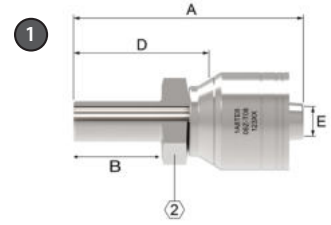

## Standpipe straight tube

PART ① Z part #	HOSE SIZE INFO		DIMENSIONS								
	Tube O.D.	Hose size	A		D		EØ		②	B	
	in		mm	in	mm	in	mm	in	in	mm	in
<b>04Z-T04</b>	1/4	-04	55,6	2.19	35,56	1.40	4,3	0.17	9/16	25,4	1.00
<b>06Z-T06</b>	3/8	-06	59,7	2.35	38,61	1.52	6,6	0.26	11/16	25,4	1.00
<b>08Z-T08</b>	1/2	-08	68,3	2.69	43,18	1.70	9,7	0.38	13/16	27,9	1.10
<b>10Z-T10</b>	5/8	-10	71,1	2.80	45,47	1.79	12,7	0.50	15/16	29,2	1.15
<b>12Z-T12</b>	3/4	-12	73,7	2.90	46,74	1.84	15,5	0.61	11/8	30,2	1.19
<b>16Z-T16</b>	1	-16	87,1	3.43	53,59	2.11	20,6	0.81	13/8	33,5	1.32

Braided series

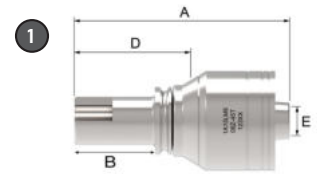

## Metric standpipe straight tube

PART 1 Z part #	HOSE SIZE INFO		DIMENSIONS							
	Tube O. D.	Hose size	A		D		EØ		B	
			mm	in	mm	in	mm	in	mm	in
<b>04Z-38T</b>	8	-04	56,4	2.22	33.0	1.30	4,1	0.16	23	0.91
<b>04Z-40T</b>	10	-04	56,4	2.22	33.0	1.30	4,3	0.17	23	0.91
<b>06Z-40T</b>	10	-06	59,4	2.34	34,3	1.35	6,6	0.26	23	0.91
<b>06Z-42T</b>	12	-06	60,5	2.38	35.0	1.38	6,6	0.26	24	0.95
<b>06Z-44T</b>	14	-06	61,5	2.42	36,1	1.42	6,6	0.26	25	0.98
<b>08Z-45T</b>	15	-08	66,8	2.63	37,1	1.46	9,7	0.38	25	0.98
<b>08Z-46T</b>	16	-08	68,1	2.68	38,4	1.51	9,7	0.38	26	1.02
<b>10Z-48T</b>	18	-10	69,1	2.72	39.6	1.56	12,7	0.05	27	1.06
<b>10Z-50T</b>	20	-10	69,1	2.72	39.6	1.56	12,7	0.50	27	1.06
<b>12Z-52T</b>	22	-12	71,1	2.80	40,9	1.61	15,5	0.61	28	1.10
<b>12Z-55T</b>	25	-12	70,1	2.76	39,9	1.57	15,5	0.61	27	1.06
<b>16Z-58T</b>	28	-16	75,7	2.98	41.4	1.63	20,6	0.81	28	1.10
<b>16Z-60T</b>	30	-16	75,9	2.99	41,7	1.64	20,6	0.81	28	1.10

**Weatherhead**

Braided series

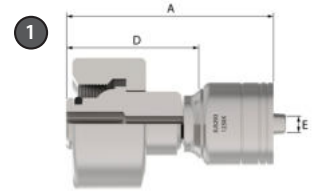
**Pressure washer connection**

PART Z part #	HOSE SIZE INFO		DIMENSIONS							
	Thread	Hose size	A		D		EØ		F Dia.	
			mm	in	mm	in	mm	in	mm	in
<b>04Z-6PW</b>	M22x1.5	-04	55,4	2.18	35,3	1.39	4,2	0.17	34,9	1.38
<b>06Z-6PW</b>	M22x1.5	-06	56,1	2.21	34,9	1.38	6,7	0.26	34,9	1.38



Braided series

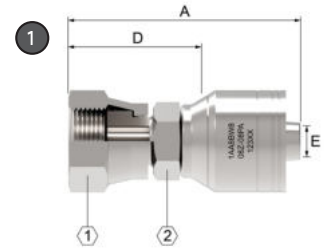

## British Standard (BSPP) flat face female swivel

PART	HOSE SIZE INFO		DIMENSIONS								
	Z part #	Thread	Hose size	A		D		E $\varnothing$		1	2
		in		mm	in	mm	in	mm	in	in	in
<b>06Z-06PA</b>	G 3/8-19	-06		57,2	2.25	36,7	1.42	6,6	0.26	3/4	11/16
<b>06Z-08PA</b>	G 1/2-14	-06		58,7	2.31	37,6	1.48	6,6	0.26	11/16	3/4
<b>08Z-08PA</b>	G 1/2-14	-08		66,8	2.63	41,7	1.64	9,2	0.36	11/16	13/16
<b>08Z-12PA</b>	G 3/4-14	-08		67,1	2.64	41,9	1.65	9,7	0.38	11/4	1
<b>12Z-12PA</b>	G 3/4-14	-12		71,1	2.80	44,2	1.74	15,5	0.61	11/4	11/8

\* G as part of thread size is ISO Designation for parallel thread.

Braided series

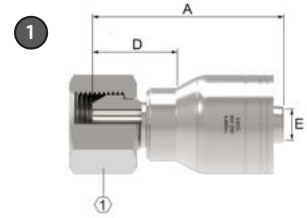

## British Standard (BSPP) 60° cone female swivel straight

PART ① Z part #	HOSE SIZE INFO		DIMENSIONS							
	Thread T	Hose size	A		D		EØ		①	
	in		mm	in	mm	in	mm	in	mm	in
<b>04Z-354</b>	G 1/4 -19*	-04	42,3	1.66	18,9	0.74	4,2	0.16	19,0	0.75
<b>04Z-356</b>	G 3/8 -19*	-04	45,5	1.79	22,1	0.87	4,3	0.17	22,0	0.87
<b>06Z-356</b>	G 3/8 -19*	-06	46,4	1.83	21,1	0.83	6,7	0.26	22,0	0.87
<b>06Z-358</b>	G 1/2 -14*	-06	47,9	1.88	22,6	0.89	6,7	0.26	27,0	1.06
<b>08Z-358</b>	G 1/2 -14*	-08	53,5	2.11	23,8	0.94	9,6	0.38	27,0	1.06
<b>08Z-360</b>	G 5/8 -14*	-08	56,4	2.22	26,7	1.05	9,6	0.38	30,0	1.18
<b>10Z-360</b>	G 5/8 -14*	-10	54,1	2.13	24,7	0.97	12,7	0.50	30,0	1.18
<b>12Z-362</b>	G 3/4 -14*	-12	55,5	2.18	25,3	1.00	15,5	0.61	32,0	1.26
<b>16Z-366</b>	G 1 -11*	-16	62,0	2.44	27,6	1.09	20,7	0.81	41,0	1.61
<b>20Z-370</b>	G 1 1/4 -11*	-20	73,6	2.90	29,6	1.16	26,6	1.05	50,0	1.97

\* G as part of thread size is ISO Designation for parallel thread.

Braided series

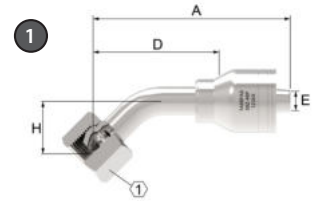

## British Standard (BSPP) 60° cone female 45° tube elbow

PART		HOSE SIZE INFO		DIMENSIONS								
1 Z part #	Thread T	Hose size	A		D		EØ		H		1	
			mm	in	mm	in	mm	in	mm	in	mm	in
<b>04Z-44P</b>	G 1/4 -19*	-04	65,3	2.57	41,9	1.65	4,2	0.16	16,5	0.65	19,0	0.75
<b>06Z-46P</b>	G 3/8 -19*	-06	73,8	2.90	48,5	1.91	6,7	0.26	19,0	0.75	22,0	0.87
<b>08Z-48P</b>	G 1/2 -14*	-08	91,5	3.60	61,8	2.43	9,6	0.38	24,8	0.98	27,0	1.06
<b>10Z-50P</b>	G 5/8 -14*	-10	100,4	3.95	71,0	2.79	12,7	0.50	27,4	1.08	30,0	1.18
<b>12Z-52P</b>	G 3/4 -14*	-12	108,8	4.28	78,6	3.09	15,5	0.61	29,4	1.16	32,0	1.26
<b>16Z-56P</b>	G 1 -11*	-16	126,8	4.99	92,4	3.09	20,7	0.81	33,2	1.31	41,0	1.61
<b>20Z-60P</b>	G 1 1/4 -11*	-20	153,6	6.05	109,6	4.31	26,6	1.05	37,2	1.46	50,0	1.97

\* G as part of thread size is ISO Designation for parallel thread.

# Weatherhead

Braided series

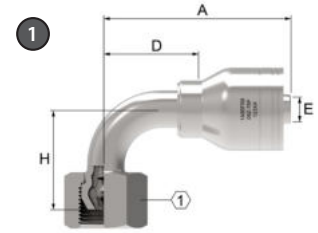

## British Standard (BSPP) 60° cone female 90° tube elbow straight

PART	HOSE SIZE INFO		DIMENSIONS									
	Thread T	Hose size	A		D		EØ		H		①	
① Z part #	in		mm	in	mm	in	mm	in	mm	in	mm	in
<b>04Z-74P</b>	G 1/4 -19*	-04	45,8	1.80	22,4	0.88	4,2	0.16	24,8	0.98	17,0	0.67
<b>06Z-76P</b>	G 3/8 -19*	-06	58,9	2.32	33,6	1.32	6,7	0.26	35,0	1.38	22,0	0.87
<b>06Z-78P</b>	G 1/2 -14*	-06	75,7	2.98	50,4	1.98	6,7	0.26	47,8	1.88	27,0	1.06
<b>08Z-78P</b>	G 1/2 -14*	-08	64,0	2.52	34,3	1.35	9,6	0.38	37,6	1.48	27,0	1.06
<b>08Z-80P</b>	G 5/8 -14*	-08	90,7	3.57	61,0	2.40	9,6	0.38	56,3	2.22	27,0	1.06
<b>10Z-80P</b>	G 5/8 -14*	-10	90,6	3.57	61,2	1.41	12,7	0.50	56,3	2.22	27,0	1.06
<b>12Z-82P</b>	G 3/4 -14*	-12	82,2	3.24	52,0	2.05	15,5	0.61	47,5	1.87	32,0	1.26
<b>16Z-86P</b>	G 1 -11*	-16	118,2	4.65	83,8	3.30	20,7	0.81	71,5	2.81	41,0	1.61
<b>20Z-90P</b>	G1 1/4- 11*	-20	146,2	5.75	102,2	4.02	26,6	1.05	82,5	3.25	50,0	1.97

\* G as part of thread size is ISO Designation for parallel thread.

Braided series

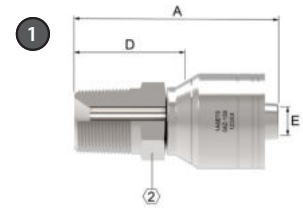

## British Standard (BSPT) tapered male rigid

PART Z part #	HOSE SIZE INFO		DIMENSIONS							
	Thread T	Hose size	A		D		EØ		1	
	in		mm	in	mm	in	mm	in	mm	in
<b>04Z-154</b>	R 1/4 -19*	-04	50,6	1.99	27,2	1.07	4,2	0.16	14,0	0.55
<b>06Z-156</b>	R 3/8 -19*	-06	54,9	2.16	29,6	1.16	6,7	0.26	19,0	0.75
<b>08Z-158</b>	R 1/2 -14*	-08	66,2	2.61	36,5	1.44	9,6	0.38	22,0	0.87
<b>12Z-162</b>	R 3/4 -14*	-12	71,1	2.80	40,9	1.61	15,5	0.61	30,0	1.18
<b>16Z-166</b>	R 1 -11*	-16	81,2	3.20	46,8	1.84	20,7	0.81	36,0	1.42
<b>20Z-170</b>	R 1 1/4 -11*	-20	96,2	3.79	52,2	2.05	26,6	1.05	46,0	1.81

\* R as part of thread size is ISO Designation for tapered thread.

# Weatherhead

Braided series

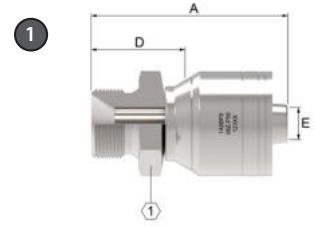

## British Standard (BSPP) 60° cone male rigid

PART	HOSE SIZE INFO		DIMENSIONS							
	Thread T	Hose size	A		D		EØ		2	
1 Z part #	in		mm	in	mm	in	mm	in	mm	in
<b>04Z-P54</b>	G 1/4 -19*	-04	44,3	1.74	20,9	0.82	4,2	0.16	19,0	0.75
<b>06Z-P56</b>	G 3/8 -19*	-06	48,4	1.90	23,1	0.91	6,7	0.26	22,0	0.87
<b>08Z-P56</b>	G 3/8 -19*	-08	55,9	2.20	26,4	1.04	9,6	0.38	22,0	0.87
<b>06Z-P58</b>	G 1/2 -14*	-06	52,4	2.06	27,1	1.07	6,7	0.26	27,0	1.06
<b>08Z-P58</b>	G 1/2 -14*	-08	58,0	2.28	28,3	1.11	9,6	0.38	27,0	1.06
<b>10Z-P60</b>	G 5/8 -14*	-10	62,0	2.44	35,5	1.25	12,7	0.50	30,0	1.18
<b>12Z-P62</b>	G 3/4 -14*	-12	63,1	2.48	32,9	1.29	15,5	0.61	32,0	1.26
<b>16Z-P66</b>	G 1 -11*	-16	70,9	2.79	36,5	1.44	20,7	0.81	41,0	1.61
<b>20Z-P67</b>	G 1 1/4 -11*	-20	86,1	3.39	42,2	1.66	26,6	1.50	50,0	1.97

\* G as part of thread size is ISO Designation for parallel thread.

Braided series

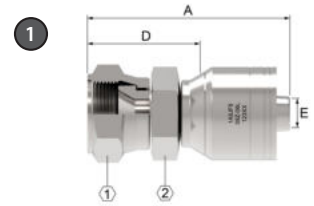

## Female JIS 30° flare swivel straight

PART Z part #	HOSE SIZE INFO		DIMENSIONS									
	Thread T	Hose size	A		D		EØ		1		2	
	in		mm	in	mm	in	mm	in	mm	in	mm	in
<b>04Z-04L</b>	G 1/4 -19*	-04	53,2	2.09	29,8	1.17	4,2	0.16	19,0	0.75	19,0	0.75
<b>06Z-06L</b>	G 3/8 -19*	-06	59,2	2.33	33,9	1.33	6,7	0.26	22,0	0.87	22,0	0.87
<b>08Z-08L</b>	G 1/2 -14*	-08	66,3	2.61	36,6	1.44	9,6	0.38	27,0	1.06	27,0	1.06
<b>10Z-12L</b>	G 3/4 -14*	-10	70,6	2.78	45,2	1.78	12,7	0.50	32,0	1.26	36,0	1.42
<b>12Z-12L</b>	G 3/4 -14*	-12	73,3	2.88	43,1	1.70	15,5	0.61	32,0	1.26	36,0	1.42
<b>16Z-16L</b>	G 1 -11*	-16	83,6	3.29	49,2	1.94	20,7	0.81	41,0	1.61	41,0	1.61
<b>20Z-20L</b>	G 1 1/4 -11*	-20	102,1	4.02	58,1	2.29	26,6	1.05	50,0	1.97	46,0	1.81

\* G as part of thread size is ISO Designation for parallel thread.

**Weatherhead**

Braided series

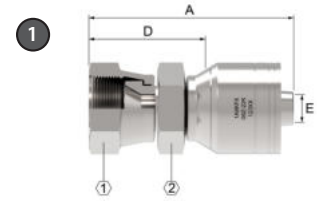
**Female swivel 30° flare** (Komatsu, Linkbelt)

PART ① Z part #	HOSE SIZE INFO		DIMENSIONS									
	Thread T	Hose size	A		D		EØ		①		②	
			mm	in	mm	in	mm	in	mm	in	mm	in
<b>04Z-14K</b>	M14 x 1.5	-04	56,1	2.21	32,7	1.29	42,2	1.66	19,0	0.75	19,0	0.75
<b>06Z-18K</b>	M18 x 1.5	-06	60,4	2.38	35,1	1.38	6,7	0.26	24,0	0.94	22,0	0.87
<b>08Z-22K</b>	M22 x 1.5	-08	69,5	2.74	39,8	1.57	9,6	0.38	27,0	1.06	27,0	1.06
<b>10Z-24K</b>	M24 x 1.5	-10	75,4	2.97	46,0	1.81	12,4	0.49	32,0	1.26	30,0	1.18
<b>12Z-30K</b>	M30 x 1.5	-12	81,5	3.21	51,3	2.02	15,5	0.61	36,0	1.42	36,0	1.42
<b>16Z-33K</b>	M33 x 1.5	-16	91,4	3.60	57,0	2.24	20,7	0.81	41,0	1.61	41,0	1.61



Braided series

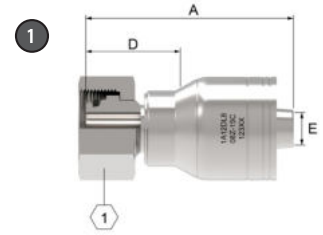

## Female swivel DIN 24° seat I.Rh DKO (Light)

PART	HOSE SIZE INFO			DIMENSIONS								
	Z part #	Thread T	Tube O.D.	Hose size	A		D		EØ		1	
					mm	in	mm	in	mm	in	mm	in
<b>04Z-06C</b>	M12 x 1.5	6	-04		48,0	1.89	24,6	0.97	4,2	0.16	17,0	0.67
<b>04Z-08C</b>	M14 x 1.5	8	-04		46,0	1.81	22,6	0.89	4,2	0.16	17,0	0.67
<b>04Z-10C</b>	M16 x 1.5	10	-04		48,3	1.90	24,9	0.98	4,3	0.17	19,0	0.75
<b>06Z-10C</b>	M16 x 1.5	10	-06		56,9	2.24	31,6	1.24	6,7	0.26	19,0	0.75
<b>06Z-12C</b>	M18 x 1.5	12	-06		51,2	2.01	25,9	1.02	6,7	0.26	22,0	0.87
<b>08Z-15C</b>	M22 x 1.5	15	-08		58,3	2.29	28,6	1.12	9,6	0.38	27,0	1.06
<b>10Z-18C</b>	M26 x 1.5	18	-10		59,2	2.33	29,8	1.17	12,7	0.50	32,0	1.26
<b>12Z-22C</b>	M30 x 2.0	22	-12		62,5	2.46	32,3	1.27	15,5	0.61	36,0	1.42
<b>16Z-28C</b>	M36 x 2.0	28	-16		68,2	2.68	33,8	1.33	20,7	0.81	41,0	1.61
<b>20Z-35C</b>	M45 x 2.0	35	-20		83,7	3.29	39,7	1.56	26,6	1.05	50,0	1.97

# Weatherhead

Braided series

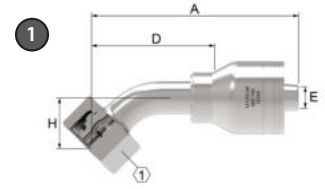

## Female swivel DIN 24° seat 45° tube elbow I. Rh. (Light)

PART ① Z part #	HOSE SIZE INFO			DIMENSIONS									
	Thread T	Tube O.D.	Hose size	A		D		EØ		①		H	
				mm	in	mm	in	mm	in	mm	in	mm	in
<b>04Z-08D</b>	M14 X 1.5	8	-04	6,2	2.46	3,9	1.54	0,4	0.17	17,5	0.69	17,0	0.67
<b>04Z-10D</b>	M16 X 1.5	10	-04	6,5	2.55	4,1	1.63	0,4	0.17	18,4	0.72	19,0	0.75
<b>06Z-10D</b>	M16 X 1.5	10	-06	6,7	2.63	4,1	1.63	0,7	0.26	19,0	0.75	19,0	0.75
<b>06Z-12D</b>	M18 X 1.5	12	-06	7,0	2.76	4,5	1.76	0,7	0.26	17,6	0.69	22,0	0.87
<b>08Z-15D</b>	M22 X 1.5	15	-08	8,3	3.27	5,3	2.10	1,0	0.38	20,5	0.81	27,0	1.06
<b>10Z-18D</b>	M26 X 1.5	18	-10	9,1	3.59	6,2	2.44	1,3	0.50	22,0	0.87	32,0	1.26
<b>12Z-22D</b>	M30 X 2.0	22	-12	10,1	3.97	7,1	2.78	1,5	0.61	24,3	0.96	36,0	1.42
<b>16Z-28D</b>	M36 X 2.0	28	-16	10,3	4.06	6,9	2.70	2,1	0.81	26,6	1.05	41,0	1.61

Braided series

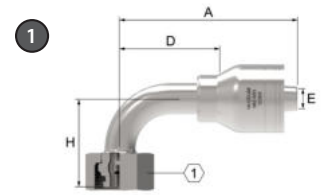

## Female swivel DIN 24° seat 90° tube elbow I. Rh. (Light)

PART ① Z part #	HOSE SIZE INFO			DIMENSIONS							
	Thread T	Tube O.D.	Hose size	A		EØ		H		①	
				mm	in	mm	in	mm	in	mm	in
<b>04Z-58D</b>	M14 x 1.5	8	-04	51,1	1.09	4,3	0.17	31,5	1.24	17,0	0.67
<b>04Z-60D</b>	M16 x 1.5	10	-04	55,4	1.26	4,3	0.17	35,5	1.40	19,0	0.75
<b>06Z-60D</b>	M16 x 1.5	10	-06	58,4	1.32	6,6	0.26	33,5	1.32	19,0	0.75
<b>06Z-62D</b>	M18 x 1.5	12	-06	59,7	1.36	6,6	0.26	34,2	1.35	22,0	0.87
<b>08Z-65D</b>	M22 x 1.5	15	-08	75,2	1.80	9,7	0.38	40,0	1.57	27,0	1.06
<b>10Z-68D</b>	M26 x 1.5	18	-10	86,4	2.24	12,7	0.50	46,5	1.83	32,0	1.26
<b>12Z-72D</b>	M30 x 2.0	22	-12	92,5	2.45	15,5	0.61	50,7	2.00	36,0	1.42
<b>16Z-78D</b>	M36 x 2.0	28	-16	100,1	2.58	20,6	0.81	61,0	2.40	41,0	1.61
<b>20Z-85D</b>	M45 x 2.0	35	-20	130,0	3.39	26,7	1.05	79,0	3.11	50,0	1.97

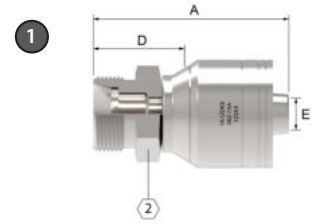

## Male DIN 24° seat I.Rh (Light)

PART ① Z part #	HOSE SIZE INFO			DIMENSIONS							
	Thread T	Tube O.D.	Hose size	A		D		EØ		②	
				mm	in	mm	in	mm	in	mm	in
<b>04Z-06A</b>	M12 x 1.5	6	-04	44,7	1.76	21,3	0.84	4,2	0.16	12,0	0.47
<b>04Z-08A</b>	M14 x 1.5	8	-04	44,5	1.75	21,1	0.83	4,2	0.16	14,0	0.55
<b>04Z-10A</b>	M16 X 1.5	10	-04	46,0	1.81	22,6	0.89	4,3	0.17	17,0	0.67
<b>06Z-10A</b>	M16 x 1.5	10	-06	52,0	2.05	26,7	1.05	6,7	0.26	17,0	0.67
<b>06Z-12A</b>	M18 x 1.5	12	-06	49,0	1.93	23,7	0.93	6,7	0.26	19,0	0.75
<b>08Z-15A</b>	M22 x 1.5	15	-08	56,0	2.20	26,3	1.03	9,6	0.38	24,0	0.94
<b>10Z-18A</b>	M26 x 1.5	18	-10	56,0	2.20	26,6	1.05	12,7	0.50	27,0	1.06
<b>12Z-22A</b>	M30 x 2.0	22	-12	62,0	2.44	31,8	1.25	15,5	0.61	32,0	1.26
<b>16Z-28A</b>	M36 x 2.0	28	-16	66,0	2.60	31,6	1.24	20,7	0.81	41,0	1.61
<b>20Z-35A</b>	M45 x 2.0	35	-20	79,4	3.12	35,4	1.39	26,6	1.05	46,0	1.81

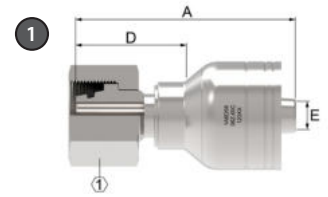

## Female swivel DIN 24° seat s.Rh DKO (Heavy)

PART Z part #	HOSE SIZE INFO			DIMENSIONS							
	Thread T	Tube O.D.	Hose size	A		D		EØ		①	
				mm	in	mm	in	mm	in	mm	in
<b>04Z-58C</b>	M16 x 1.5	8	-04	49,6	1.95	26,2	1.03	4,2	0.16	19,0	0.75
<b>04Z-60C</b>	M18 x 1.5	10	-04	50,8	2.00	27,4	1.08	4,2	0.16	22,0	0.87
<b>04Z-62C</b>	M20 X 1.5	12	-04	50,8	2.00	27,4	1.08	4,3	0.17	24,0	0.94
<b>06Z-60C</b>	M18 X 1.5	10	-06	52,8	2.08	27,7	1.09	6,6	0.26	27,0	1.06
<b>06Z-62C</b>	M20 x 1.5	12	-06	53,8	2.12	28,5	1.12	6,7	0.26	24,0	0.94
<b>06Z-64C</b>	M22 x 1.5	14	-06	56,9	2.24	31,6	1.24	6,7	0.26	27,0	1.06
<b>08Z-64C</b>	M22 x 1.5	14	-08	55,2	2.17	25,5	1.00	9,6	0.38	27,0	1.06
<b>08Z-66C</b>	M24 x 1.5	16	-08	62,4	2.46	32,7	1.29	9,6	0.38	30,0	1.18
<b>10Z-70C</b>	M30 x 2.0	20	-10	66,9	2.63	37,5	1.48	12,7	0.50	36,0	1.42
<b>12Z-75C</b>	M36 x 2.0	25	-12	72,0	2.83	41,8	1.64	15,5	0.61	46,0	1.81
<b>12Z-70C</b>	M30 X 2.0	20	-12	60,2	2.37	30,2	1.19	14,0	0.55	36,0	1.42
<b>16Z-80C</b>	M42 x 2.0	30	-16	78,5	3.09	44,1	1.44	20,7	0.81	50,0	1.97
<b>20Z-88C</b>	M52 X 2.0	38	-20	93,7	3.69	49,8	1.96	26,6	1.05	60,0	2,36

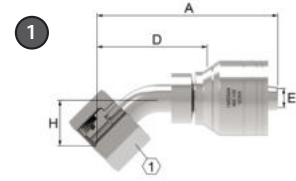

## Female swivel DIN 24° seat 45° tube elbow s.Rh (Heavy)

PART ① Z part #	HOSE SIZE INFO			DIMENSIONS									
	Thread T	Tube O.D.	Hose size	A		D		EØ		H		①	
				mm	in	mm	in	mm	in	mm	in	mm	in
<b>04Z-08E</b>	M16 x 1.5	8	-04	56,4	2.22	33,0	1.30	4,2	0.16	15,0	0.59	19,0	0.75
<b>04Z-10E</b>	M18 x 1.5	10	-04	61,4	2.42	38,0	1.50	4,2	0.16	17,0	0.67	22,0	0.87
<b>06Z-12E</b>	M20 x 1.5	12	-06	68,3	2.69	43,0	1.69	6,7	0.26	19,0	0.75	24,0	0.94
<b>06Z-14E</b>	M22 x 1.5	14	-06	68,8	2.71	43,5	1.71	6,7	0.26	20,0	0.79	27,0	1.06
<b>08Z-16E</b>	M24 x 1.5	16	-08	79,7	3.14	50,0	1.97	9,6	0.38	23,0	0.90	30,0	1.18
<b>10Z-20E</b>	M30 x 2.0	20	-10	89,3	3.51	59,9	2.36	12,7	0.50	26,0	1.02	36,0	1.42
<b>12Z-25E</b>	M36 x 2.0	25	-12	107,4	4.23	77,2	3.04	15,5	0.61	32,5	1.28	46,0	1.81

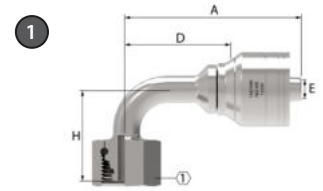

## Female swivel DIN 24° seat 90° tube elbow s.Rh DKO (Heavy)

PART ① Z part #	HOSE SIZE INFO			DIMENSIONS									
	Thread T	Tube O.D.	Hose size	A		D		EØ		H		①	
				mm	in	mm	in	mm	in	mm	in	mm	in
<b>04Z-58E</b>	M16 x 1.5	8	-04	54,0	2.13	30,6	1.20	4,2	0.16	28,6	1.13	19,0	0.75
<b>04Z-60E</b>	M18 x 1.5	10	-04	54,5	2.14	31,0	1.22	4,2	0.16	33,5	1.32	22,0	0.87
<b>06Z-60E</b>	M18 x 1.5	10	-06	63,9	2.52	38,6	1.52	6,7	0.26	33,5	1.32	22,0	0.87
<b>06Z-62E</b>	M20 x 1.5	12	-06	60,3	2.37	35,0	1.38	6,7	0.26	35,0	1.38	24,0	0.94
<b>06Z-64E</b>	M22 x 1.5	14	-06	63,8	2.51	38,5	1.51	6,7	0.26	42,0	1.65	27,0	1.06
<b>08Z-66E</b>	M24 x 1.5	16	-08	73,7	2.90	44,0	1.73	9,6	0.38	49,0	1.93	30,0	1.18
<b>10Z-70E</b>	M30 x 2.0	20	-10	82,0	3.23	52,6	2.07	12,7	0.50	53,5	2.11	36,0	1.42
<b>12Z-75E</b>	M36 x 2.0	25	-12	93,0	3.66	62,8	2.47	15,5	0.61	64,5	2.54	46,0	1.81

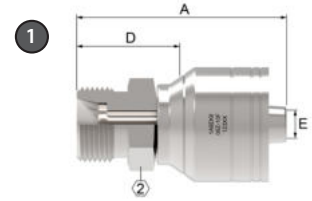

## Male DIN 24° seat s.Rh (Heavy)

PART 1 Z part #	HOSE SIZE INFO			DIMENSIONS							
	Thread T	Tube O.D.	Hose size	A		D		EØ		1	
				mm	in	mm	in	mm	in	mm	in
<b>04Z-08F</b>	M16 x 1.5	8	-04	47,5	1.87	24,1	0.95	4,2	0.16	17,0	0.67
<b>04Z-10F</b>	M18 x 1.5	10	-04	40,7	1.60	23,6	0.93	4,2	0.16	19,0	0.75
<b>06Z-10F</b>	M18 X 1.5	10	-06	49,5	1.95	24,1	0.95	6,7	0.26	19,0	0.75
<b>06Z-12F</b>	M20 x 1.5	12	-06	50,3	1.98	25,0	0.98	6,7	0.26	22,0	0.87
<b>06Z-14F</b>	M22 x 1.5	14	-06	52,6	2.07	27,3	1.07	6,7	0.26	24,0	0.94
<b>08Z-16F</b>	M24 x 1.5	16	-08	58,0	2.28	28,3	1.11	9,6	0.38	27,0	1.06
<b>10Z-20F</b>	M30 x 2.0	20	-10	62,0	2.44	32,6	1.28	12,7	0.50	32,0	1.26
<b>12Z-20F</b>	M30 X 2.0	20	-12	57,7	2.27	30,7	1.21	15,5	0.61	32,0	1.26
<b>12Z-25F</b>	M36 x 2.0	25	-12	65,5	2.58	35,3	1.39	15,5	0.61	41,0	1.61
<b>16Z-30F</b>	M42 x 2.0	30	-16	72,3	2.85	37,9	1.49	20,7	0.81	46,0	1.81



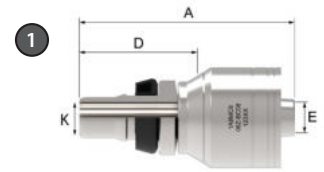

## STC male straight

PART	DIMENSIONS					
1 Z part #	E		A		D	
	mm	in	mm	in	mm	in
<b>04Z-BC06</b>	4,2	0.17	52,4	2.06	29,0	1.14
<b>06Z-BC06</b>	6,7	0.26	55,5	2.19	30,2	1.19
<b>06Z-BC08</b>	6,7	0.26	60,6	2.39	35,4	1.39
<b>08Z-BC08</b>	9,6	0.38	66,3	2.61	36,6	1.44
<b>10Z-BC10</b>	12,8	0.50	69,0	2.72	39,6	1.56
<b>12Z-BC12</b>	15,5	0.61	74,6	2.94	44,4	1.75
<b>16Z-BC16</b>	0,7	0.82	83,7	3.30	49,3	1.94

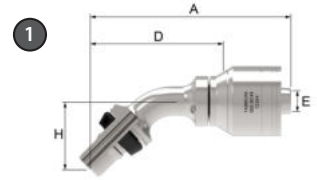

## STC male 45° tube elbow

PART		DIMENSIONS							
1 Z part #	E		A		D		H		
	mm	in	mm	in	mm	in	mm	in	
<b>04Z-BC46</b>	4,2	0.17	69,8	2.75	46,4	1.83	22,2	0.86	
<b>06Z-BC46</b>	6,7	0.26	72,9	2.87	47,6	1.87	22,2	0.87	
<b>08Z-BC48</b>	8,8	0.35	89,9	3.54	60,2	2.37	29,6	1.17	
<b>10Z-BC50</b>	11,5	0.45	97,8	3.85	68,4	2.69	33,6	1.32	
<b>12Z-BC52</b>	13,9	0.55	110,2	4.34	80,0	3.15	40,7	1.60	

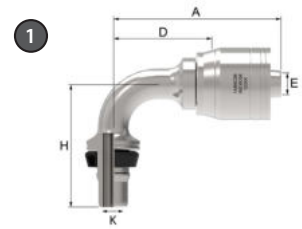

## STC male 90° tube elbow

PART		DIMENSIONS							
1 Z part #	E		A		D		H		
	mm	in	mm	in	mm	in	mm	in	
<b>06Z-BC66</b>	6,7	0.26	59,3	2.33	34,0	1.34	39,6	1.56	
<b>06Z-BC68</b>	6,7	0.26	66,4	2.61	41,1	1.62	53,0	2.09	
<b>08Z-BC68</b>	8,8	0.35	72,0	2.83	42,3	1.67	53,0	2.09	
<b>10Z-BC70</b>	11,5	0.45	77,9	3.07	48,5	1.91	60,4	2.36	
<b>12Z-BC72</b>	13,9	0.55	88,7	3.49	58,5	2.30	75,7	2.98	
<b>16Z-BC76</b>	19,9	0.78	107,3	4.22	72,9	2.87	90,0	3.54	

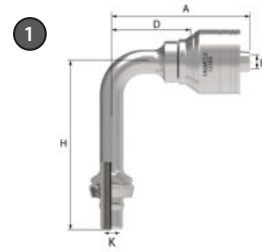

## STC male 90° long drop elbow

PART	DIMENSIONS							
1 Z part #	E		A		D		H	
	mm	in	mm	in	mm	in	mm	in
<b>06Z-BC86</b>	6,4	0.25	59,3	2.33	34,0	1.34	70,6	2.78
<b>08Z-BC88</b>	9,1	0.36	72,0	2.84	42,3	1.67	88,1	3.46
<b>12Z-BC92</b>	13,9	0.55	88,7	3.49	58,5	2.30	123,7	4.87

Weatherhead by Danfoss

## Braided fittings

Reusable 1R & 2R series

# Weatherhead

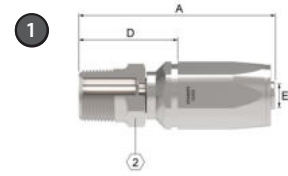

## MP

Male Pipe

PART #			HOSE SIZE INFO		DIMENSIONS					
1 Assy part #	Nipple/nipple assy	New reusable socket	Thread size	Hose size	A		D		EØ	
					mm	in	mm	in	mm	in
1RA2MP4	4202-2-4S	1RA4	1/8-27	-04	55,1	2.17	28,7	1.13	4,3	0.17
1RA4MP4	4202-4-4S	1RA4	1/4-18	-04	59,9	2.36	33,5	1.32	4,3	0.17
1RA4MP6	4202-4-6S	1RA6	1/4-18	-06	68,1	2.68	39,4	1.55	7,6	0.30
1RA6MP6	4202-6-6S	1RA6	3/8-18	-06	69,8	2.75	36,9	1.45	7,9	0.31
1RA6MP8	4202-6-8S	1RA8	3/8-18	-08	71,6	2.82	34,3	1.35	9,9	0.39
1RA8MP8	4202-8-8S	1RA8	1/2-14	-08	78,0	3.07	40,6	1.60	9,9	0.39
1RA12MP12	4202-12-12S	1RA12	3/4-14	-12	90,2	3.55	49,5	1.95	15,5	0.61
1RA16MP16	4202-16-16S	1RA16	1-11 1/2	-16	108,0	4.25	54,1	2.13	20,8	0.82

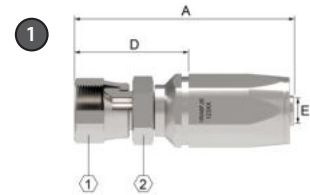

## FJ

SAE 37° (JIC) swivel

PART #			HOSE SIZE INFO		DIMENSIONS					
1 Assy part #	Nipple/nipple assy	New reusable socket	Thread size	Hose size	A		D		EØ	
					mm	in	mm	in	mm	in
1RA4FJ4	4103-4-4-4S	1RA4	7/16/20	-04	63,5	2.50	37,1	1.46	4,3	0.17
1RA6FJ6	4103-4-6-6S	1RA6	9/16-18	-06	73,9	2.91	45,2	1.78	7,9	0.31
1RA8FJ8	4103-4-8-8S	1RA8	3/4-16	-08	80,8	3.18	42,8	1.68	9,9	0.39
1RA12FJ12	4103-4-12S	1RA12	1 1/16-12	-12	96,5	3.80	55,9	2.20	15,5	0.61
1RA16FJ16	4103-4-16S	1RA16	1 5/16-12	-16	110,0	4.33	56,1	2.21	20,8	0.82

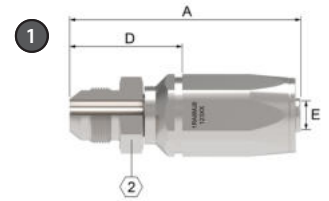

## MJ

SAE 37° (JIC) male flare

PART #			HOSE SIZE INFO		DIMENSIONS					
1 Assy part #	Nipple/nipple assy	New reusable socket	Thread size	Hose size	A		D		EØ	
					mm	in	mm	in	mm	in
1RA4MJ4	4203-4-4S	1RA4	7/16-20	-04	59,4	2.34	33,0	1.30	4,3	0.17
1RA6MJ6	4203-6-6S	1RA6	9/16-18	-06	67,8	2.67	39,1	1.54	7,9	0.31
1RA8MJ8	4203-8-8S	1RA8	3/4-16	-08	75,4	2.97	37,6	1.48	9,9	0.39
1RA12MJ12	4203-12S	1RA12	1 1/16-12	-12	93,0	3.66	52,3	2.06	15,5	0.61
1RA16MJ16	4203-16S	1RA16	1 5/16-12	-16	107,4	4.23	53,3	2.10	20,8	0.82

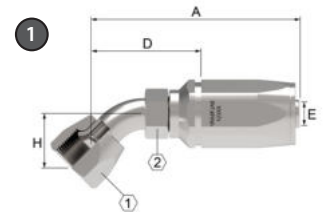

## FJA

SAE 37° (JIC) swivel 45° elbow

PART #			HOSE SIZE INFO		DIMENSIONS							
1 Assy part #	Nipple/nipple assy	New reusable socket	Thread size	Hose size	A		D		EØ		DIM H	
					mm	in	mm	in	mm	in	mm	in
1RA4FJA4	185287-4S	1RA4	7/16-20	-04	60,2	2.37	33,8	1.33	4,3	0.17	8,4	0.33
1RA6FJA6	185287-6S	1RA6	9/16-18	-06	69,9	2.75	41,1	1.62	7,9	0.31	9,9	0.39
1RA8FJA8	185287-8S	1RA8	3/4-16	-08	82,3	3.24	45,0	1.77	9,9	0.39	14,0	0.55
1RA12FJA12	185287-12S	1RA12	1 1/16-12	-12	104,3	4.11	62,7	2.40	14,8	0.58	19,8	0.78
1RA16FJA16	185287-16S	1RA16	1 5/16-12	-16	124,0	4.88	69,9	2.75	20,8	0.82	27,2	1.07

# Weatherhead

1R series

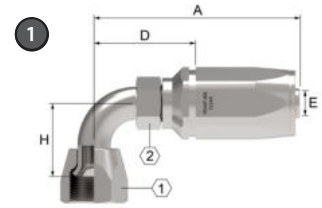

## FJB

SAE 37° (JIC) swivel 90° elbow (short)

PART			HOSE SIZE INFO		DIMENSIONS							
1 Assy part #	Nipple/nipple assy	New reusable socket	Thread size	Hose size	A		D		EØ		DIM H	
					mm	in	mm	in	mm	in	mm	in
<b>1RA4FJB4</b>	<b>185264-4S</b>	<b>1RA4</b>	7/16-20	-04	60,0	2.36	31,0	1.22	3,9	0.15	17,3	0.68
<b>1RA6FJB6</b>	<b>185264-6S</b>	<b>1RA6</b>	9/16-18	-06	67,3	2.65	38,6	1.52	7,9	0.31	21,6	0.85
<b>1RA8FJB8</b>	<b>185264-8S</b>	<b>1RA8</b>	3/4-16	-08	76,2	3.00	39,1	1.54	9,9	0.39	27,7	1.09
<b>1RA12FJB12</b>	<b>185264-12S</b>	<b>1RA12</b>	1 1/16-12	-12	102,9	4.05	62,2	2.45	15,5	0.61	46,2	1.82
<b>1RA16FJB16</b>	<b>185264-16S</b>	<b>1RA16</b>	1 5/16-12	-16	119,1	4.69	65,0	2.56	20,8	0.82	60,7	2.39

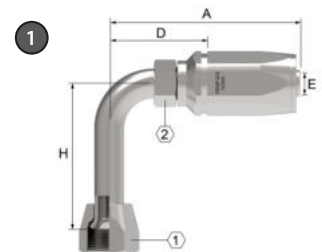

## FJC

SAE 37° (JIC) swivel 90° elbow (long)

PART			HOSE SIZE INFO		DIMENSIONS							
1 Assy part #	Nipple/nipple assy	New reusable socket	Thread size	Hose size	A		D		EØ		DIM H	
					mm	in	mm	in	mm	in	mm	in
<b>1RA4FJC4</b>	<b>185263-4S</b>	<b>1RA4</b>	7/16-20	-04	69,1	2.72	36,1	1.42	6,2	0.24	45,7	1.80
<b>1RA6FJC6</b>	<b>185263-6S</b>	<b>1RA6</b>	9/16-18	-06	67,3	2.65	38,6	1.52	7,9	0.31	55,4	2.18
<b>1RA8FJC8</b>	<b>185263-8S</b>	<b>1RA8</b>	3/4-16	-08	79,2	3.13	42,2	1.66	9,9	0.39	61,7	2.43
<b>1RA12FJC12</b>	<b>185263-12S</b>	<b>1RA12</b>	1 1/16-12	-12	102,9	4.05	62,2	2.45	15,5	0.61	94,7	3.73
<b>1RA16FJC16</b>	<b>185263-16S</b>	<b>1RA16</b>	1 5/16-12	-16	119,1	4.69	65,0	2.56	20,8	0.82	116,3	4.58



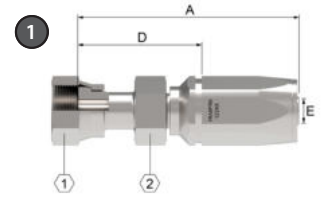

## FR

ORS swivel

PART			HOSE SIZE INFO		DIMENSIONS					
1 Assy part #	Nipple/nipple assy	New reusable socket	Thread size	Hose size	A		D		EØ	
					mm	in	mm	in	mm	in
1RA4FR4	FJ8732-0404S	1RA4	9/16/18	-04	66,5	2.62	40,1	1.58	4,1	0.16
1RA6FR6	FJ8732-0606S	1RA6	11/16-16	-06	74,9	2.95	46,2	1.82	6,6	0.26
1RA8FR8	FJ8732-0808S	1RA8	13/16-16	-08	85,9	3.38	47,9	1.89	9,6	0.38
1RA12FR12	FJ8732-1212S	1RA12	1 3/16 -12	-12	101,6	4.00	60,9	2.40	14,0	0.55
1RA16FR16	FJ8732-1616S	1RA16	1 7/16 -12	-16	117,9	4.64	63,8	2.51	19,8	0.78

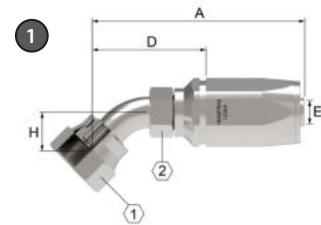

## FRA

ORS swivel 45° elbow

PART			HOSE SIZE INFO		DIMENSIONS							
1 Assy part #	Nipple/nipple assy	New reusable socket	Thread size	Hose size	A		D		EØ		DIM H	
					mm	in	mm	in	mm	in	mm	in
1RA4FRA4	FJ8733-0404S	1RA4	9/16-18	-04	63,0	2.48	40,1	1.58	4,3	0.17	10,4	0.41
1RA6FRA6	FJ8733-0606S	1RA6	11/16-16	-06	70,9	2.79	46,2	1.82	6,6	0.26	10,9	0.43
1RA8FRA8	FJ8733-0808S	1RA8	13/16-16	-08	83,3	3.28	48,5	1.91	9,7	0.38	15,0	0.59
1RA12FRA12	FJ8733-1212S	1RA12	1 3/16 -12	-12	105,4	4.15	60,9	2.40	15,5	0.61	21,1	0.83
1RA16FRA16	FJ8733-1616S	1RA16	1 7/16 -12	-16	124,7	4.91	72,5	2.85	19,3	0.76	24,1	0.95

# Weatherhead

1R series

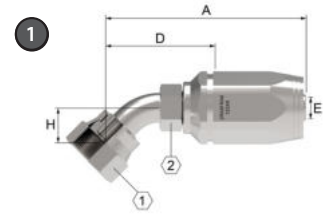

## FRB

ORS swivel 90° elbow

PART			HOSE SIZE INFO		DIMENSIONS							
1 Assy part #	Nipple/nipple assy	New reusable socket	Thread size	Hose size	A		D		EØ		DIM H	
					mm	in	mm	in	mm	in	mm	in
<b>1RA4FRB4</b>	<b>FJ8734-0404S</b>	<b>1RA4</b>	9/16-18	-04	58,9	2.32	32,5	1.28	4,3	0.17	20,8	0.82
<b>1RA6FRB6</b>	<b>FJ8734-0606S</b>	<b>1RA6</b>	11/16-16	-06	69,1	2.72	36,1	1.42	6,2	0.24	23,1	0.91
<b>1RA8FRB8</b>	<b>FJ8734-0808S</b>	<b>1RA8</b>	13/16-16	-08	76,5	3.01	39,1	1.54	9,7	0.38	29,2	1.15
<b>1RA12FRB12</b>	<b>FJ8734-1212S</b>	<b>1RA12</b>	1 3/16-12	-12	102,9	4.05	62,2	2.45	15,5	0.61	47,8	1.88
<b>1RA16FRB16</b>	<b>FJ8734-1616S</b>	<b>1RA16</b>	1 7/16-12	-16	119,1	4.69	65,3	2.57	20,6	0.81	56,1	2.21

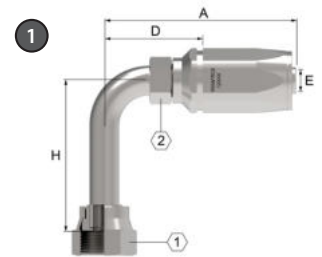

## FRC

ORS swivel 90° elbow long drop

PART			HOSE SIZE INFO		DIMENSIONS							
1 Assy part #	Nipple/nipple assy	New reusable socket	Thread size	Hose size	A		D		EØ		DIM H	
					mm	in	mm	in	mm	in	mm	in
<b>1RA4FRC4</b>	<b>FJ8735-0404S</b>	<b>1RA4</b>	9/16-18	-04	58.9	2.32	32.5	1.28	4.3	0.17	45.7	1.80
<b>1RA6FRC6</b>	<b>FJ8735-0606S</b>	<b>1RA6</b>	11/16-16	-06	70.4	2.77	41.7	1.64	6.6	0.26	54.1	2.13
<b>1RA8FRC8</b>	<b>FJ8735-0808S</b>	<b>1RA8</b>	13/16-16	-08	79.5	3.13	41.7	1.64	9.4	0.37	63.2	2.49
<b>1RA12FRC12</b>	<b>FJ8735-1212S</b>	<b>1RA12</b>	1 3/16-12	-12	102.9	4.05	62.2	2.45	15.5	0.61	96.0	3.78
<b>1RA16FRC16</b>	<b>FJ8735-1616S</b>	<b>1RA16</b>	1 7/16-12	-16	119.1	4.69	65.3	2.57	20.6	0.81	114.3	4.50

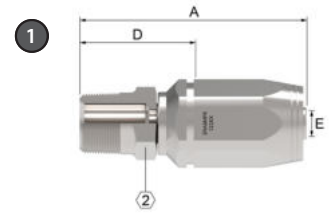

## MP

Male Pipe

PART			HOSE SIZE INFO		DIMENSIONS					
1 Assy part #	Nipple/nipple assy	New reusable socket	Thread size	Hose size	A		D		EØ	
					mm	in	mm	in	mm	in
<b>2RA4MP4</b>	<b>4202-4-4S</b>	<b>2RA4</b>	1/4-18	-04	63,5	2.50	33,8	1.33	4,3	0.17
<b>2RA6MP6</b>	<b>4202-6-6S</b>	<b>2RA6</b>	3/8-18	-06	69,9	2.75	35,8	1.41	7,9	0.31
<b>2RA6MP8</b>	<b>4202-6-8S</b>	<b>2RA8</b>	3/8-18	-08	72,1	2.84	34,5	1.36	9,9	0.39
<b>2RA8MP8</b>	<b>4202-8-8S</b>	<b>2RA8</b>	1/2-14	-08	74,5	3.09	40,1	1.58	9,9	0.39
<b>2RA12MP12</b>	<b>4202-12-12S</b>	<b>2RA12</b>	3/4-14	-12	91,7	3.61	44,2	1.74	15,5	0.61
<b>2RA12MP16</b>	<b>4202-16-16S</b>	<b>2RA16</b>	1-11 1/2	-16	111,8	4.40	59,7	2.35	20,8	0.82

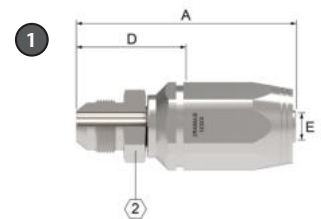

## FJ

SAE 37° (JIC) swivel

PART			HOSE SIZE INFO		DIMENSIONS					
1 Assy part #	Nipple/nipple assy	New reusable socket	Thread size	Hose size	A		D		EØ	
					mm	in	mm	in	mm	in
<b>2RA4FJ4</b>	<b>4103-4-4-4S</b>	<b>2RA4</b>	7/16-20	-04	63,2	2.49	33,5	1.32	4,3	0.17
<b>2RA6FJ6</b>	<b>4103-4-6-6S</b>	<b>2RA6</b>	9/16-18	-06	69,9	2.75	35,8	1.41	7,9	0.31
<b>2RA8FJ8</b>	<b>4103-4-8-8S</b>	<b>2RA8</b>	3/4-16	-08	75,9	2.99	37,6	1.48	9,9	0.39
<b>2RA12FJ12</b>	<b>4103-4-12S</b>	<b>2RA12</b>	1 1/16-12	-12	98,1	3.86	53,6	2.11	15,5	0.61
<b>2RA16FJ16</b>	<b>4103-4-16S</b>	<b>2RA16</b>	1 5/16-12	-16	111,3	4.38	59,2	2.33	20,8	0.82

# Weatherhead

2R series

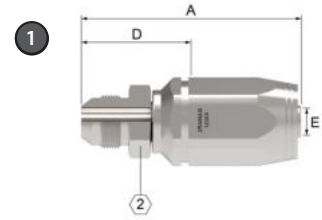

## MJ

SAE 37° (JIC) male flare

PART			HOSE SIZE INFO		DIMENSIONS					
1 Assy part #	Nipple/nipple assy	New reusable socket	Thread size	Hose size	A		D		EØ	
					mm	in	mm	in	mm	in
<b>2RA4MJ4</b>	<b>4203-4-4S</b>	<b>2RA4</b>	7/16-20	-04	63,2	2.49	33,5	1.32	4,3	0.17
<b>2RA6MJ6</b>	<b>4203-6-6S</b>	<b>2RA6</b>	9/16-18	-06	69,9	2.75	37,3	1.47	7,5	0.30
<b>2RA8MJ8</b>	<b>4203-8-8S</b>	<b>2RA8</b>	3/4-16	-08	75,9	2.99	37,6	1.48	9,9	0.39
<b>2RA12MJ12</b>	<b>4203-12S</b>	<b>2RA12</b>	1 1/16-12	-12	94,5	3.72	47,0	1.85	15,5	0.61
<b>2RA16FJA16</b>	<b>4203-16S</b>	<b>2RA16</b>	1 5/16-12	-16	111,3	4.38	59,2	2.33	20,8	0.82

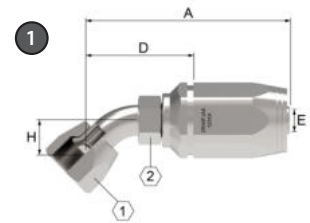

## FJA

SAE 37° (JIC) swivel 45° elbow

PART			HOSE SIZE INFO		DIMENSIONS							
1 Assy part #	Nipple/nipple assy	New reusable socket	Thread size	Hose size	A		D		EØ		DIM H	
					mm	in	mm	in	mm	in	mm	in
<b>2RA4FJA4</b>	<b>185287-4S</b>	<b>2RA4</b>	7/16-20	-04	63,8	2.51	34,0	1.34	3,9	0.15	8,0	0.32
<b>2RA6FJA6</b>	<b>185287-6S</b>	<b>2RA6</b>	9/16-18	-06	71,6	2.82	37,6	1.48	7,9	0.31	9,9	0.39
<b>2RA8FJA8</b>	<b>185287-8S</b>	<b>2RA8</b>	3/4-16	-08	82,8	3.26	44,5	1.75	9,9	0.39	14,0	0.55
<b>2RA12FJA12</b>	<b>185287-12S</b>	<b>2RA12</b>	1 1/16-12	-12	105,4	4.15	57,9	2.28	15,5	0.61	19,8	0.78
<b>2RA16FJA16</b>	<b>185287-16S</b>	<b>2RA16</b>	1 5/16-12	-16	127,8	5.03	75,7	2.98	20,8	0.82	27,2	1.07

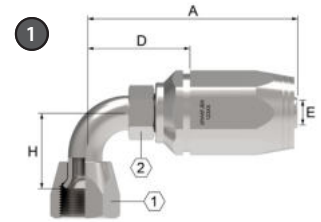

## FJB

SAE 37° (JIC) swivel 90° elbow (short)

PART			HOSE SIZE INFO		DIMENSIONS							
1 Assy part #	Nipple/nipple assy	New reusable socket	Thread size	Hose size	A		D		EØ		DIM H	
					mm	in	mm	in	mm	in	mm	in
<b>2RA4FJB4</b>	<b>185264-4S</b>	<b>2RA4</b>	7/16-20	-04	60,9	2.40	31,2	1.23	4,3	0.17	17,3	0.68
<b>2RA6FJB6</b>	<b>185264-6S</b>	<b>2RA6</b>	9/16-18	-06	69,1	2.72	35,1	1.38	7,9	0.31	21,6	0.85
<b>2RA8FJB8</b>	<b>185264-8S</b>	<b>2RA8</b>	3/4-16	-08	76,7	3.02	39,2	1.54	9,4	0.37	27,7	1.09
<b>2RA12FJB12</b>	<b>185264-12S</b>	<b>2RA12</b>	1 1/16-12	-12	104,4	4.11	56,9	2.24	15,5	0.61	46,2	1.82
<b>2RA16FJB16</b>	<b>185264-16S</b>	<b>2RA16</b>	1 5/16-12	-16	122,9	4.84	70,9	2.79	20,8	0.82	60,7	2.39

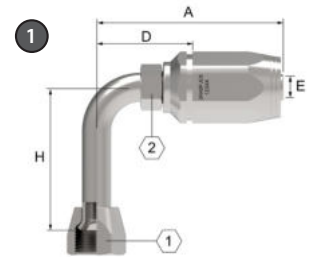

## FJC

SAE 37° (JIC) swivel 90° elbow (long)

PART			HOSE SIZE INFO		DIMENSIONS							
1 Assy part #	Nipple/nipple assy	New reusable socket	Thread size	Hose size	A		D		EØ		DIM H	
					mm	in	mm	in	mm	in	mm	in
<b>2RA4FJC4</b>	<b>185263-4S</b>	<b>2RA4</b>	7/16-20	-04	60,9	2.40	31,2	1.23	4,3	0.17	46,7	1.80
<b>2RA6FJC6</b>	<b>185263-6S</b>	<b>2RA6</b>	9/16-18	-06	69,1	2.72	36,7	1.45	6,2	0.24	55,4	2.18
<b>2RA8FJC8</b>	<b>185263-8S</b>	<b>2RA8</b>	3/4-16	-08	76,7	3.02	38,6	1.52	9,9	0.39	61,7	2.43
<b>2RA12FJC12</b>	<b>185263-12S</b>	<b>2RA12</b>	1 1/16-12	-12	104,4	4.11	56,9	2.24	15,5	0.61	94,7	3.73
<b>2RA16FJC16</b>	<b>185263-16S</b>	<b>2RA16</b>	1 5/16-12	-16	122,9	4.84	70,9	2.79	20,8	0.82	116,3	4.58

# Weatherhead

2R series

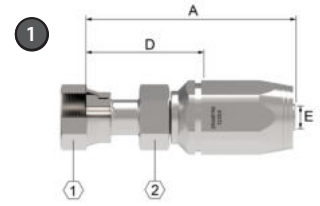

## FR

ORS swivel

PART			HOSE SIZE INFO		DIMENSIONS					
1 Assy part #	Nipple/nipple assy	New reusable socket	Thread size	Hose size	A		D		EØ	
					mm	in	mm	in	mm	in
2RA4FR4	FJ8732-0404S	2RA4	9/16/18	-04	70.1	2.76	40.3	1.59	4.1	0.16
2RA6FR6	FJ8732-0606S	2RA6	11/16-16	-06	77.0	3.03	42.9	1.69	6.6	0.26
2RA8FR8	FJ8732-0808S	2RA8	13/16-16	-08	86.4	3.40	48.7	1.92	9.6	0.38
2RA12FR12	FJ8732-1212S	2RA12	1 3/16 -12	-12	103.1	4.06	59.9	2.36	14.0	0.55
2RA16FR16	FJ8732-1616S	2RA16	1 7/16 -12	-16	121.7	4.79	69.6	2.74	19.8	0.78

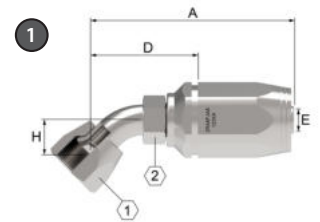

## FRA

ORS 45° elbow

PART			HOSE SIZE INFO		DIMENSIONS							
1 Assy part #	Nipple/nipple assy	New reusable socket	Thread size	Hose size	A		D		EØ		DIM H	
					mm	in	mm	in	mm	in	mm	in
2RA4FRA4	FJ8733-0404S	2RA4	9/16-18	-04	66,5	2.62	36,8	1.45	4,3	0.17	10,4	0.41
2RA6FRA6	FJ8733-0606S	2RA6	11/16-16	-06	72,9	2.87	38,9	1.53	6,6	0.26	10,9	0.43
2RA8FRA8	FJ8733-0808S	2RA8	13/16-16	-08	83,8	3.30	45,5	1.79	9,7	0.38	15,0	0.59
2RA12FRA12	FJ8733-1212S	2RA12	1 3/16 -12	-12	106,9	4.21	62,4	2.46	14,5	0.58	21,1	0.83
2RA16FRA16	FJ8733-1616S	2RA16	1 7/16 -12	-16	124,7	4.91	72,6	2.86	20,6	0.81	23,9	0.94

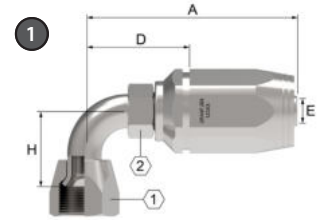

## FRB

ORS swivel 90° elbow

PART			HOSE SIZE INFO		DIMENSIONS							
1 Assy part #	Nipple/nipple assy	New reusable socket	Thread size	Hose size	A		D		EØ		DIM H	
					mm	in	mm	in	mm	in	mm	in
<b>2RA4FRB4</b>	<b>FJ8734-0404S</b>	<b>2RA4</b>	9/16-18	-04	62,7	2.47	33,0	1.30	4,3	0.17	20,8	0.82
<b>2RA6FRB6</b>	<b>FJ8734-0606S</b>	<b>2RA6</b>	11/16-16	-06	69,1	2.72	36,7	1.45	6,2	0.24	23,1	0.91
<b>2RA8FRB8</b>	<b>FJ8734-0808S</b>	<b>2RA8</b>	13/16-16	-08	77,0	3.03	38,6	1.52	9,7	0.38	29,2	1.15
<b>2RA12FRB12</b>	<b>FJ8734-1212S</b>	<b>2RA12</b>	1 3/16-12	-12	104,4	4.11	56,9	2.24	15,5	0.61	47,8	1.88
<b>2RA16FRB16</b>	<b>FJ8734-1616S</b>	<b>2RA16</b>	1 7/16-12	-16	122,9	4.84	70,9	2.79	20,6	0.81	56,1	2.21

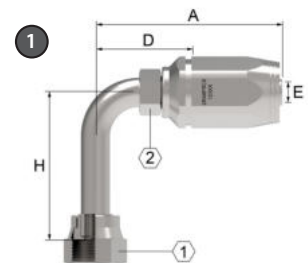

## FRC

ORS Swivel

PART			HOSE SIZE INFO		DIMENSIONS							
1 Assy part #	Nipple/nipple assy	New reusable socket	Thread size	Hose size	A		D		EØ		DIM H	
					mm	in	mm	in	mm	in	mm	in
<b>2RA4FRC4</b>	<b>FJ8735-0404S</b>	<b>2RA4</b>	9/16-18	-04	62,7	2.47	33,0	1.30	4,3	0.17	45,7	1.80
<b>2RA6FRC6</b>	<b>FJ8735-0606S</b>	<b>2RA6</b>	11/16-16	-06	69,1	2.72	35,1	1.38	6,6	0.26	54,1	2.13
<b>2RA8FRC8</b>	<b>FJ8735-0808S</b>	<b>2RA8</b>	13/16-16	-08	77,0	3.03	38,6	1.52	9,7	0.38	63,8	2.51
<b>2RA12FRC12</b>	<b>FJ8735-1212S</b>	<b>2RA12</b>	1 3/16-12	-12	104,4	4.11	59,9	2.36	14,8	0.58	96,7	3.80
<b>2RA16FRC16</b>	<b>FJ8735-1616S</b>	<b>2RA16</b>	1 7/16-12	-16	122,9	4.84	70,9	2.79	20,6	0.81	114,3	4.50

## **Weatherhead**

---



Winner by Danfoss

## Braided fittings

Winner standard series



# Winner

## Ordering information

### Winner standard crimp fittings

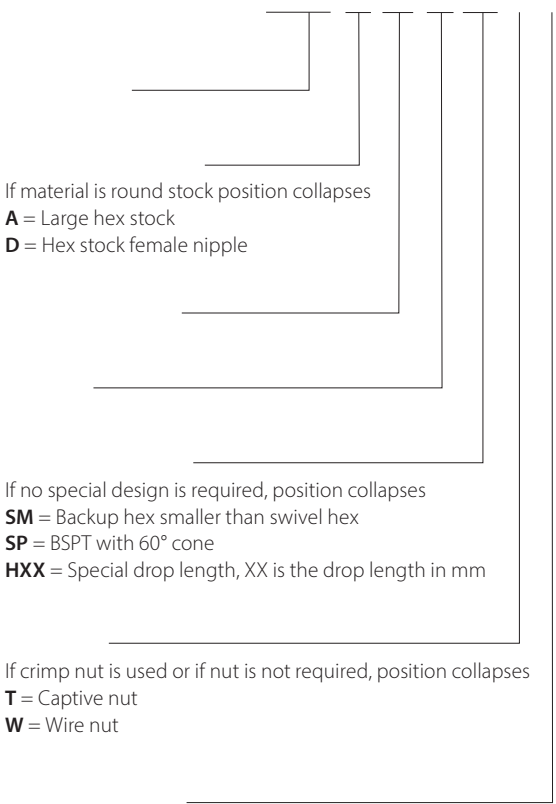

If material is round stock position collapses  
**A** = Large hex stock  
**D** = Hex stock female nipple

If no special design is required, position collapses  
**SM** = Backup hex smaller than swivel hex  
**SP** = BSPT with 60° cone  
**HXX** = Special drop length, XX is the drop length in mm

If crimp nut is used or if nut is not required, position collapses  
**T** = Captive nut  
**W** = Wire nut

**ZF** = Zinc Trivalent Chromate (Cr3)

Braided – standard fittings

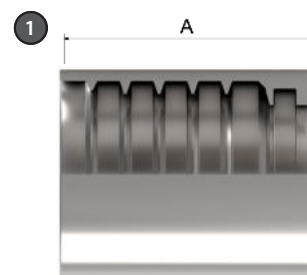

## 00110

Crimp Socket 1 wire For use with hose: EC115 and EC118

PART #	HOSE SIZE INFO		DIMENSIONS				WEIGHT	
1 Part #	DN	Dash Size	A		OD		Weight	
			mm	in	mm	in	kg	lb
<b>00110-04ANZF</b>	6	-04	27,5	1.08	21.0	0.83	0.03	0.07
<b>00110-06ANZF</b>	10	-06	30,0	1.18	24.3	0.96	0.04	0.08
<b>00110-08ANZF</b>	12	-08	34,0	1.34	28.0	1.10	0.05	0.10
<b>00110-10ANZF</b>	16	-10	37,0	1.46	31.3	1.23	0.06	0.13
<b>00110-12ANZF</b>	20	-12	42,0	1.65	28.7	1.13	0.08	0.17
<b>00110-16ANZF</b>	25	-16	51,0	2.01	43.5	1.71	0.13	0.28

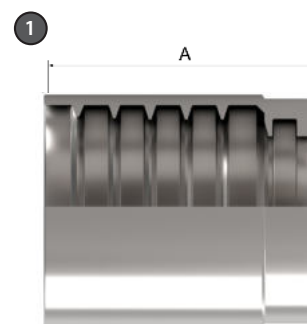

## 03310

Crimp Socket 2 wire For use with hose: EC215 and WH004

PART #	HOSE SIZE INFO		DIMENSIONS				WEIGHT	
1 Part #	DN	Dash Size	A		OD		Weight	
			mm	in	mm	in	kg	lb
<b>03310-04NZF</b>	6	-04	30.5	1.20	23.0	0.91	0.04	0.09
<b>03310-06NZF</b>	10	-06	32.0	1.26	26.0	1.02	0.04	0.09
<b>03310-08NZF</b>	12	-08	34.0	1.34	29.0	1.14	0.05	0.10
<b>03310-10ANZF</b>	16	-10	35.0	1.38	34.5	1.36	0.06	0.14
<b>03310-12NZF</b>	20	-12	42.0	1.65	37.0	1.46	0.08	0.18
<b>03310-16NZF</b>	25	-16	52.0	2.05	46.7	1.84	0.15	0.33

# Winner

Braided – standard fittings

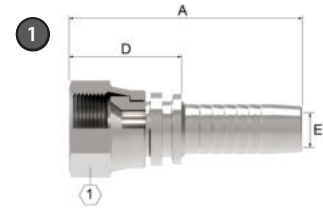

## 26711

Female JIC/SAE 37° Swivel For use with hose: EC115, EC215 and EC118

PART		HOSE SIZE INFO				DIMENSIONS						WEIGHT	
① Part #	Terminal End	Thread	Hose Size		A		D Cut Off Factor		E Ø		①	Weight	
	Dash Size		DN	Dash Size	mm	in	mm	in	mm	in	mm	kg	lb
<b>26711-04-04ZF</b>	-04	7/16"-20	6	-04	43.0	1.69	15.0	0.59	4.0	0.16	14	0.020	0.044
<b>26711-06-04ZF</b>	-06	9/16"-18	6	-04	43.5	1.71	15.5	0.61	4.0	0.16	19	0.032	0.071
<b>26711-06-06ZF</b>	-06	9/16"-18	10	-06	45.5	1.79	15.5	0.61	7.0	0.28	19	0.037	0.082
<b>26711-08-06ZF</b>	-08	3/4"-16	10	-06	47.5	1.87	17.5	0.69	7.0	0.28	22	0.054	0.119
<b>26711-08-08ZF</b>	-08	3/4"-16	12	-08	50.0	1.97	18.5	0.73	9.9	0.39	22	0.060	0.132
<b>26711-10-08ZF</b>	-10	7/8"-14	12	-08	50.5	1.99	19.0	0.75	10.0	0.39	27	0.090	0.198
<b>26711-10-10ZF</b>	-10	7/8"-14	16	-10	53.5	2.11	19.5	0.77	12.0	0.47	27	0.100	0.220
<b>26711-12-12ZF</b>	-12	1 1/16"-12	20	-12	60.0	2.36	21.5	0.85	15.0	0.59	32	0.130	0.287
<b>26711-16-16ZF</b>	-16	1 5/16"-12	25	-16	70.0	2.76	23.0	0.91	21.0	0.83	41	0.210	0.463

Braided – standard fittings

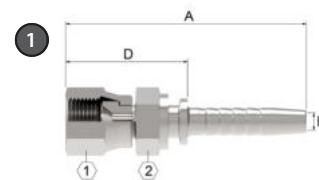

## 26711D

Female JIC/SAE 37° Swivel\* For use with hose: EC115, EC215 and EC118

PART		HOSE SIZE INFO				DIMENSIONS							WEIGHT	
1 Part #	Terminal End	Thread	Hose Size		A		D Cut Off Factor		E Ø		1	2	Weight	
	Dash Size		DN	Dash Size	mm	in	mm	in	mm	in	mm	mm	kg	lb
<b>26711D-04-04ZF</b>	-04	7/16"-20	6	-04	57.0	2.24	29.0	1.14	4.0	0.16	14	14	0.03	0.07
<b>26711D-06-04ZF</b>	-06	9/16"-18	6	-04	59.0	2.32	31.0	1.22	3.9	0.15	19	19	0.04	0.10
<b>26711D-06-06ZF</b>	-06	9/16"-18	10	-06	61.0	2.40	31.0	1.22	6.9	0.27	19	19	0.05	0.10
<b>26711D-08-06ZF</b>	-08	3/4"-16	10	-06	66.0	2.60	36.0	1.42	6.9	0.27	22	22	0.08	0.18
<b>26711D-08-08ZF</b>	-08	3/4"-16	12	-08	67.0	2.64	35.5	1.40	9.8	0.38	22	22	0.08	0.17
<b>26711D-10-08ZF</b>	-10	7/8"-14	12	-08	70.5	2.78	39.0	1.54	9.9	0.39	27	27	0.10	0.23
<b>26711D-10-10ZF</b>	-10	7/8"-14	16	-10	61.0	2.40	27.0	1.06	12.0	0.47	27	27	0.12	0.26
<b>26711D-12-10ZF</b>	-12	1 1/16"-12	16	-10	79.5	3.13	45.5	1.79	11.9	0.47	32	32	0.18	0.39
<b>26711D-12-12ZF</b>	-12	1 1/16"-12	20	-12	84.5	3.33	46.0	1.81	14.9	0.59	32	32	0.19	0.41
<b>26711D-12-16ZF</b>	-12	1 3/16"-12	25	-16	95.0	3.74	48.0	1.89	20.9	0.82	32	36	0.23	0.50
<b>26711D-16-12ZF</b>	-16	1 5/16"-12	20	-12	86.6	3.41	48.1	1.89	14.9	0.59	41	41	0.30	0.65
<b>26711D-16-16ZF</b>	-16	1 5/16"-12	25	-16	96.7	3.81	49.7	1.96	20.9	0.82	41	41	0.32	0.71

# Winner

Braided – standard fittings

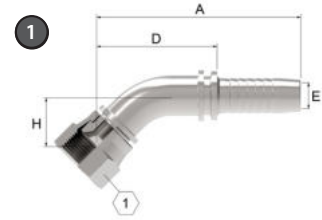

## 26741

Female JIC/SAE 37° Swivel 45° Elbow For use with hose: EC115, EC215 and EC118

PART		HOSE SIZE INFO				DIMENSIONS								WEIGHT	
1 Part #	Terminal End	Thread	Hose Size		A		D Cut Off Factor		E Ø		H		1	Weight	
	Dash Size		DN	Dash Size	mm	in	mm	in	mm	in	mm	in	mm	kg	lb
<b>26741-04-04ZF</b>	-04	7/16"-20	6	-04	63.1	2.48	35.1	1.38	4.0	0.16	13.0	0.51	14	0.035	0.077
<b>26741-06-06ZF</b>	-06	9/16"-18	10	-06	68.8	2.71	38.8	1.53	7.0	0.28	14.8	0.58	19	0.062	0.137
<b>26741-08-08ZF</b>	-08	3/4"-16	12	-08	76.8	3.02	45.3	1.78	10.0	0.39	19.0	0.75	22	0.105	0.231
<b>26741-10-10ZF</b>	-10	7/8"-14	16	-10	88.4	3.48	54.4	2.14	12.0	0.47	22.1	0.87	27	0.146	0.322
<b>26741-12-12ZF</b>	-12	1 1/16"-12	20	-12	97.8	3.85	59.3	2.33	15.0	0.59	24.2	0.95	32	0.240	0.529
<b>26741-16-16ZF</b>	-16	1 5/16"-12	25	-16	121.3	4.78	74.3	2.93	21.0	0.83	28.7	1.13	41	0.400	0.882
<b>26741-04-04H10ZF</b>	-04	7/16"-12	6	-04	59.0	2.32	31.0	1.22	3.9	0.15	10.0	0.39	14	0.01	0.01
<b>26741-06-04H11ZF</b>	-06	9/6"-18	6	-04	60.0	2.36	3.02	1.26	3.9	0.15	11.0	0.43	19	0.01	0.02
<b>26741-06-06H11ZF</b>	-06	9/6"-18	10	-06	65.7	2.59	35.7	1.41	6.9	0.27	11.0	0.43	19	0.05	0.11
<b>26741-08-06TZF</b>	-08	3/4"-16	10	-06	70.4	2.77	40.4	1.59	6.9	0.27	15.0	0.59	22	0.07	0.15
<b>26741-08-08H15ZF</b>	-08	3/4"-16	12	-08	78.9	3.11	47.4	1.87	9.9	0.39	15.0	0.59	22	0.07	0.16
<b>26741-10-10H16ZF</b>	-10	7/8"-14	16	-10	87.4	3.44	53.4	2.10	11.9	0.47	16.0	0.63	27	0.12	0.26
<b>26741-12-12H21ZF</b>	-12	1 1/16"-12	20	-12	95.4	3.76	56.9	2.24	14.9	0.59	21.0	0.83	32	0.19	0.42
<b>26741-16-16H24ZF</b>	-16	1 5/16"-12	25	-16	119.47	4.7	72.47	2.85	20.9	0.82	24.0	0.94	41	0.36	0.80

Braided – standard fittings

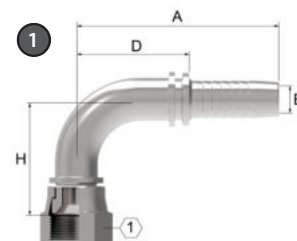

# 26791

Female JIC/SAE 37° Swivel 90° Elbow For use with hose: EC115, EC215 and EC118

PART	HOSE SIZE INFO				DIMENSIONS									WEIGHT	
	Terminal End	Thread	Hose Size		A		D Cut Off Factor		E Ø		H		①	Weight	
① Part #	Dash Size		DN	Dash Size	mm	in	mm	in	mm	in	mm	in		mm	kg
<b>26791-04-04ZF</b>	-04	7/16"-20	6	-04	58.0	2.28	30.0	1.18	4.0	0.16	26.3	1.04	14	0.040	0.088
<b>26791-06-04ZF</b>	-06	9/16"-18	6	-04	58.0	2.28	30.0	1.18	4.0	0.16	27.0	1.06	19	0.048	0.106
<b>26791-06-06ZF</b>	-06	9/16"-18	10	-06	64.5	2.54	34.5	1.36	7.0	0.28	31.5	1.24	19	0.070	0.154
<b>26791-08-08ZF</b>	-08	3/4"-16	12	-08	71.0	2.80	39.5	1.56	10.0	0.39	40.0	1.57	22	0.118	0.260
<b>26791-10-08ZF</b>	-10	7/8"-14	12	-08	71.0	2.80	39.5	1.56	10.0	0.39	42.0	1.65	27	0.132	0.291
<b>26791-10-10ZF</b>	-10	7/8"-14	16	-10	83.0	3.27	49.0	1.93	12.0	0.47	47.5	1.87	27	0.190	0.419
<b>26791-12-12ZF</b>	-12	1 1/16"-12	20	-12	93.0	3.66	54.5	2.15	15.0	0.59	53.5	2.11	32	0.300	0.661
<b>26791-16-16ZF</b>	-16	1 5/16"-12	25	-16	118.0	4.65	71.0	2.80	21.0	0.83	66.1	2.60	41	0.460	1.014
<b>26791-04-04H21ZF</b>	-04	7/16"-20	6	-04	55.3	2.18	27.3	1.07	3.9	0.15	21.0	0.83	14	0.03	0.06
<b>26791-06-04H23ZF</b>	-06	9/16"-18	6	-04	55.3	2.18	27.3	1.07	3.9	0.15	23.0	0.91	19	0.04	0.09
<b>26791-06-06H23ZF</b>	-06	9/16"-18	10	-06	61.8	2.43	31.8	1.25	6.9	0.27	23.0	0.91	19	0.05	0.11
<b>26791-06-06H54ZF</b>	-06	9/16"-18	10	-06	64.5	2.54	34.5	1.36	6.9	0.27	54.0	2.13	19	0.08	0.17
<b>26791-08-06H29ZF</b>	-08	3/4"-16	10	-06	68.5	2.7	38.5	1.52	6.9	0.27	29.0	1.14	22	0.08	0.17
<b>26791-08-08H29ZF</b>	-08	3/4"-16	12	-08	78.5	3.09	47.0	1.85	9.9	0.39	29.0	1.14	22	0.08	0.18
<b>26791-10-08H32ZF</b>	-10	7/8"-14	12	-08	76.0	2.99	44.5	1.75	9.9	0.39	32.0	1.26	27	0.11	0.25
<b>26791-10-10H32ZF</b>	-10	7/8"-14	16	-10	83.5	3.29	49.5	1.95	11.9	0.47	32.0	1.26	27	0.12	0.27
<b>26791-12-10H48ZF</b>	-12	1 1/16"-12	16	-10	83.0	3.27	49.0	1.93	11.9	0.47	48.0	1.89	32	0.21	0.46
<b>26791-12-10H96ZF</b>	-12	1 1/16"-12	16	-10	83.0	3.27	49.0	1.93	12.0	0.47	96.0	3.78	32	0.26	0.58
<b>26791-12-12H48ZF</b>	-12	1 1/16"-12	20	-12	92.8	3.65	54.3	2.14	14.9	0.59	48.0	1.89	32	0.22	0.49
<b>26791-12-12H96ZF</b>	-12	1 1/16"-12	20	-12	93.0	3.66	54.5	2.15	14.9	0.59	96.0	3.78	32	0.33	0.72
<b>26791-16-16H56ZF</b>	-16	1 5/16"-12	25	-16	118.3	4.66	71.3	2.81	20.9	0.82	56.0	2.2	41	0.48	1.06

# Winner

Braided – standard fittings

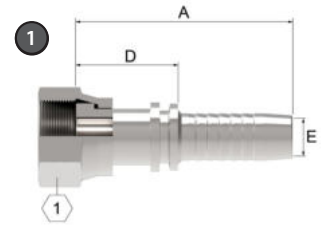

## 24211

Female ORS Swivel For use with hose: EC115, EC215 and EC118

PART		HOSE SIZE INFO				DIMENSIONS						WEIGHT	
① Part #	Terminal End	Thread	Hose Size		A		D Cut Off Factor		E Ø		①	Weight	
	Dash Size		DN	Dash Size	mm	in	mm	in	mm	in	mm	kg	lb
<b>24211-04-04ZF</b>	-04	9/16"x18	6	-04	50.5	1.99	22.5	0.89	4.0	0.16	17	0.034	0.075
<b>24211-06-06ZF</b>	-06	11/16"x16	10	-06	55.5	2.19	25.5	1.00	7.0	0.28	22	0.055	0.121
<b>24211-08-08ZF</b>	-08	13/16"x16	12	-08	59.5	2.34	28.0	1.10	10.0	0.39	27	0.086	0.190
<b>24211-10-10ZF</b>	-10	1"x14	16	-10	67.0	2.64	33.0	1.30	12.0	0.47	30	0.120	0.265
<b>24211-12-12ZF</b>	-12	1 3/16"x12	20	-12	73.5	2.89	35.0	1.38	15.0	0.59	36	0.195	0.430
<b>24211-16-16TZF</b>	-16	1 7/16"x12	25	-16	82.0	3.23	35.0	1.38	21.0	0.83	41	0.260	0.573



Braided – standard fittings

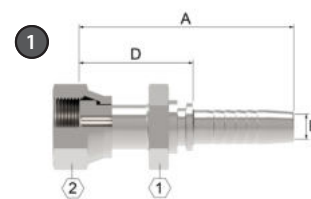

## 24211D

Female ORS Swivel\* For use with hose: EC115, EC215 and EC118

PART		HOSE SIZE INFO				DIMENSIONS						WEIGHT		
1 Part #	Terminal End	Thread	Hose Size		A		D Cut Off Factor		E Ø		1	2	Weight	
	Dash size		DN	Dash Size	mm	in	mm	in	mm	in	mm	mm	kg	lb
<b>24211D-04-04ZF</b>	-04	9/16"-18	6	-04	56.0	2.20	28.0	1.10	4.00	0.16	19	17	0.04	0.09
<b>24211D-06-04ZF</b>	-06	11/16"-16	6	-04	60.5	2.38	32.5	1.28	4.00	0.16	22	22	0.07	0.15
<b>24211D-06-06ZF</b>	-06	11/16"-16	10	-06	63.5	2.50	33.5	1.32	7.00	0.28	22	22	0.08	0.17
<b>24211D-06-08ZF</b>	-06	11/16"-16	12	-08	65.5	2.58	34.0	1.34	10.0	0.39	22	22	0.09	0.19
<b>24211D-08-06ZF</b>	-08	13/16"-16	10	-06	65.5	2.58	35.5	1.40	7.00	0.28	24	24	0.11	0.24
<b>24211D-08-08ZF</b>	-08	13/16"-16	12	-08	67.5	2.66	36.0	1.42	10.0	0.39	24	24	0.11	0.24
<b>24211D-08-10ZF</b>	-08	13/16"-16	16	-10	71.0	2.80	37.0	1.46	11.9	0.47	24	24	0.13	0.29
<b>24211D-10-08SMZF</b>	-10	1"-14	12	-08	70.0	2.76	38.5	1.52	10.0	0.39	24	30	0.14	0.30
<b>24211D-10-08ZF</b>	-10	1"-14	12	-08	72.5	2.85	41.0	1.61	9.90	0.39	30	30	0.17	0.36
<b>24211D-10-10SMZF</b>	-10	1"-14	16	-10	74.0	2.91	39.0	1.54	11.5	0.45	24	30	0.16	0.35
<b>24211D-10-10ZF</b>	-10	1"-14	16	-10	76.0	2.99	42.0	1.65	11.9	0.47	30	30	0.18	0.39
<b>24211D-10-12ZF</b>	-10	1"-14	20	-12	81.5	3.21	43.0	1.69	15.0	0.59	30	30	0.20	0.44
<b>24211D-12-08ZF</b>	-12	1 3/16"-12	12	-08	75.8	2.98	44.3	1.74	9.90	0.39	36	36	0.25	0.56
<b>24211D-12-10ZF</b>	-12	1 3/16"-12	16	-10	79.5	3.13	45.5	1.79	11.9	0.47	36	36	0.26	0.56
<b>24211D-12-12ZF</b>	-12	1 3/16"-12	20	-12	84.0	3.31	45.5	1.79	14.9	0.59	36	36	0.26	0.58
<b>24211D-12-16ZF</b>	-12	1 3/16"-12	25	-16	93.5	3.68	46.5	1.83	20.9	0.82	36	36	0.29	0.65
<b>24211D-16-12ZF</b>	-16	1 7/16"-12	20	-12	86.5	3.41	48.0	1.89	14.9	0.59	41	41	0.33	0.73
<b>24211D-16-16ZF</b>	-16	1 7/16"-12	25	-16	96.0	3.78	49.0	1.93	20.9	0.82	41	41	0.36	0.78

# Winner

Braided – standard fittings

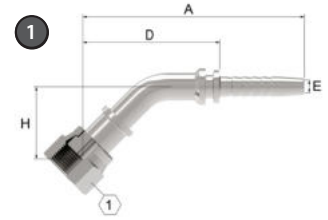

## 24241

Female ORS Swivel 45° Elbow For use with hose: EC115, EC215 and EC118

PART	HOSE SIZE INFO				DIMENSIONS								WEIGHT		
	Terminal End	Thread	Hose Size		A		D Cut Off Factor		E Ø		H		1	Weight	
1 Part #	Dash size		DN	Dash Size	mm	in	mm	in	mm	in	mm	in	mm	kg	lb
<b>24241-04-04H10ZF</b>	-04	9/16"-18	6	-04	59.5	2.34	34.5	1.36	3.9	0.15	10	0.39	17	0.03	0.07
<b>24241-04-06H10ZF</b>	-04	9/16"-18	10	-06	66.9	2.63	36.9	1.45	7.0	0.28	10	0.39	17	0.04	0.09
<b>24241-06-04H11TZF</b>	-06	11/16"-16	6	-04	63.5	2.50	35.5	1.40	3.9	0.15	11	0.43	22	0.06	0.13
<b>24241-06-06H11ZF</b>	-06	11/16"-16	10	-06	64.9	2.56	34.9	1.37	7.0	0.28	11	0.43	22	0.06	0.12
<b>24241-08-06H15TZF</b>	-08	13/16"-16	10	-06	71.3	2.81	41.3	1.63	6.9	0.27	15	0.59	24	0.08	0.17
<b>24241-08-08H15ZF</b>	-08	13/16"-16	12	-08	80.9	3.19	49.4	1.94	9.9	0.39	15	0.59	24	0.11	0.24
<b>24241-10-08H16TZF</b>	-10	1"-14	12	-08	82.4	3.24	50.9	2.00	10.0	0.39	16	0.63	30	0.15	0.34
<b>24241-10-10H16ZF</b>	-10	1"-14	16	-10	86.6	3.41	52.6	2.07	11.9	0.47	16	0.63	30	0.14	0.30
<b>24241-12-12H21ZF</b>	-12	1 3/16"-12	20	-12	106.9	4.21	68.4	2.69	14.9	0.59	21	0.83	36	0.29	0.64
<b>24241-16-16H24TZF</b>	-16	1 7/16"-12	25	-16	123.4	4.86	76.4	3.01	20.9	0.82	24	0.94	41	0.36	0.80

Braided – standard fittings

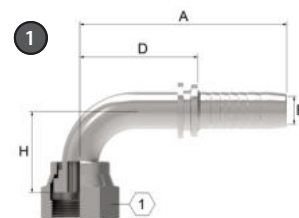

# 24291

Female ORS Swivel 90° Elbow For use with hose: EC115, EC215 and EC118

PART	HOSE SIZE INFO				DIMENSIONS								WEIGHT		
	Terminal End	Thread	Hose Size		A		D Cut Off Factor		E Ø		H		Weight		
1 Part #	Dash Size		DN	Dash Size	mm	in	mm	in	mm	in	mm	in	mm	kg	lb
24291-04-04ZF	-04	9/16"×18	6	-04	58.0	2.28	30.0	1.18	4.0	0.16	41.0	1.61	17	0,052	0.115
24291-06-06ZF	-06	11/16"×16	10	-06	65.3	2.57	35.3	1.39	7.0	0.28	42.5	0.17	22	0,090	0.198
24291-08-08ZF	-08	13/16"×16	12	-08	72.5	2.85	41.0	1.61	10.0	0.39	57.5	2.26	27	0,145	0.320
24291-10-10ZF	-10	1"×14	16	-10	90.0	3.54	56.0	2.20	12.0	0.47	66.0	2.60	30	0,235	0.518
24291-12-12ZF	-12	1.3/16"×12	20	-12	104.0	4.09	65.5	2.58	15.0	0.59	77.0	3.03	36	0,390	0.860
24291-16-16TZF	-16	1.7/16"×12	25	-16	123.9	4.88	76.9	3.03	21.0	0.83	67.5	2.66	41	0,504	1.111
24291-04-04H21ZF	-04	9/16"-18	6	-04	59.5	2.34	31.5	1.24	4.0	0.16	21.0	0.83	17	0.04	0.08
24291-06-04H23TZF	-06	11/16"-16	6	-04	59.5	2.34	31.5	1.24	3.9	0.15	23.0	0.91	22	0.06	0.13
24291-06-04H38TZF	-06	11/16"-16	6	-04	58.0	2.28	30.0	1.18	3.9	0.15	38.0	1.50	22	0.07	0.15
24291-06-04H54TZF	-06	11/16"-16	6	-04	58.0	2.28	30.0	1.18	3.9	0.15	54.0	2.13	22	0.08	0.17
24291-06-06H23ZF	-06	11/16"-16	10	-06	64.5	2.54	34.5	1.36	7.0	0.28	23.0	0.91	22	0.06	0.12
24291-06-06H38ZF	-06	11/16"-16	10	-06	66.0	2.60	36.0	1.42	6.9	0.27	38.0	1.50	22	0.07	0.16
24291-06-06H54ZF	-06	11/16"-16	10	-06	65.3	2.57	35.3	1.39	7.0	0.28	54.0	2.13	22	0.08	0.17
24291-06-08H23ZF	-06	11/16"-16	12	-08	72.9	2.87	41.4	1.63	9.9	0.39	23.0	0.91	22	0.08	0.17
24291-08-06H29TZF	-08	13/16"-16	10	-06	66.0	2.60	36.0	1.42	7.0	0.28	29.0	1.14	24	0.08	0.18
24291-08-08H29ZF	-08	13/16"-16	12	-08	73.0	2.87	41.5	1.63	9.0	0.35	29.0	1.14	24	0.10	0.21
24291-08-08H41ZF	-08	13/16"-16	12	-08	79.0	3.11	47.5	1.87	9.9	0.39	41.0	1.61	24	0.13	0.28
24291-08-08H64ZF	-08	13/16"-16	12	-08	72.5	2.85	41.0	1.61	9.9	0.39	64.0	2.52	24	0.15	0.34
24291-08-10H29ZF	-08	13/16"-16	16	10	86.7	3.41	52.7	2.07	11.9	0.47	29.0	1.14	24	0.13	0.28
24291-10-08H32TZF	-10	1"-14	12	-08	74.0	2.91	42.5	1.67	10.0	0.39	32.0	1.26	30	0.15	0.34
24291-10-08H47TZF	-10	1"-14	12	-08	72.5	2.85	41.0	1.61	9.9	0.39	47.0	1.85	30	0.17	0.37
24291-10-08H70TZF	-10	1"-14	12	-08	72.5	2.85	41.0	1.61	9.9	0.39	70.0	2.76	30	0.19	0.42
24291-10-10H32ZF	-10	1"-14	16	-10	83.5	3.29	49.5	1.95	12.0	0.47	32.0	1.26	30	0.14	0.32
24291-10-10H47ZF	-10	1"-14	16	-10	90.0	3.54	56.0	2.20	11.9	0.47	47.0	1.85	30	0.20	0.45
24291-10-10H70ZF	-10	1"-14	16	-10	90.0	3.54	56.0	2.20	12.0	0.47	70.0	2.76	30	0.24	0.54
24291-10-12H32ZF	-10	1"-14	20	-12	90.8	3.57	52.3	2.06	14.9	0.59	32.0	1.26	30	0.00	0.00
24291-12-10H48TZF	-12	1 3/16"-12	16	-10	90.0	3.54	56.0	2.20	12.0	0.47	48.0	1.89	36	0.26	0.58
24291-12-10H96TZF	-12	1 3/16"-12	16	-10	90.0	3.54	56.0	2.20	11.9	0.47	96.0	3.78	36	0.33	0.73
24291-12-12H48ZF	-12	1 3/16"-12	20	-12	106.0	4.17	67.5	2.66	14.9	0.59	48.0	1.89	36	0.31	0.68
24291-12-12H58ZF	-12	1 3/16"-12	20	-12	106.0	4.17	67.5	2.66	14.9	0.59	58.0	2.28	36	0.32	0.71
24291-12-12H96ZF	-12	1 3/16"-12	20	-12	104.0	4.09	65.5	2.58	14.9	0.59	96.0	3.78	36	0.46	1.01
24291-16-12H56TZF	-16	1 7/16	20	-12	104.0	4.09	65.5	2.58	14.9	0.59	56.0	2.20	41	0.41	0.90
24291-16-16H56TZF	-16	1 7/16"-12	25	-16	119.8	4.72	72.8	2.87	20.9	0.82	56.0	2.20	41	0.44	0.96
24291-16-16H114TZF	-16	1 7/16"-12	25	-16	123.9	4.88	76.9	3.03	20.0	0.79	114	4.49	41	0.64	1.41

# Winner

Braided – standard fittings

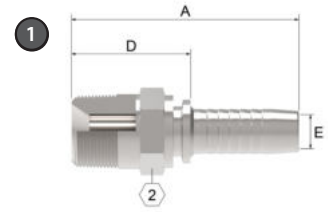

## 15611

Male Pipe - NPTF For use with hose: EC115, EC215 and EC118

PART		HOSE SIZE INFO				DIMENSIONS						WEIGHT	
① Part #	Terminal End	Thread	Hose Size		A		D Cut Off Factor		E Ø		②	Weight	
	Dash Size		DN	Dash Size	mm	in	mm	in	mm	in		mm	kg
<b>15611-F02-04ZF</b>	-02	1/8"x27	6	-04	50.5	1.99	22.5	0.89	4.0	0.16	12	0.015	0.033
<b>15611-F04-04ZF</b>	-04	1/4"x18	6	-04	56.0	2.20	28.0	1.10	4.0	0.16	17	0.030	0.066
<b>15611-F04-06ZF</b>	-04	1/4"x18	10	-06	57.5	2.26	27.5	1.08	7.0	0.28	17	0.032	0.070
<b>15611-F06-06ZF</b>	-06	3/8"x18	10	-06	59.0	2.32	29.0	1.14	7.0	0.28	19	0.048	0.106
<b>15611-F08-06ZF</b>	-08	1/2"x14	10	-06	64.0	2.52	34.0	1.34	7.0	0.28	22	0.068	0.150
<b>15611-F08-08ZF</b>	-08	1/2"x14	12	-08	66.0	2.60	34.5	1.36	10.0	0.39	22	0.075	0.165
<b>15611-F12-12ZF</b>	-12	3/4"x14	20	-12	77.0	3.03	38.5	1.52	15.0	0.59	27	0.130	0.286
<b>15611-F16-16ZF</b>	-16	1"x11.5	25	-16	93.5	3.68	46.5	1.83	21.0	0.83	36	0.230	0.506

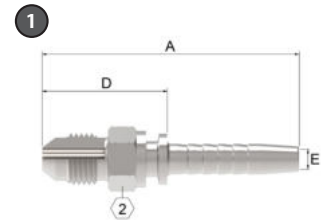

## 16711

Male JIC/SAE 37° For use with hose: EC115, EC215 and EC118

PART		HOSE SIZE INFO				DIMENSIONS						WEIGHT	
① Part #	Terminal End	Thread	Hose Size		A		D Cut Off Factor		E Ø		②	Weight	
	Dash Size		DN	Dash Size	mm	in	mm	in	mm	in		mm	kg
<b>16711-06-04ZF</b>	-06	9/16"x18	6	-04	54.5	2.15	26.5	1.04	4.00	0.16	17	0.03	0.07
<b>16711-08-06ZF</b>	-08	3/4"x16	10	-06	61.5	2.42	31.5	1.24	7.00	0.28	22	0.06	0.14
<b>16711-08-08ZF</b>	-08	3/4"x16	12	-08	63.5	2.50	32.0	1.26	9.90	0.39	22	0.06	0.13
<b>16711-10-08ZF</b>	-10	7/8"x14	12	-08	65.5	2.58	34.0	1.34	10.0	0.39	24	0.08	0.19
<b>16711-10-10ZF</b>	-10	7/8"x14	16	-10	69.0	2.72	35.0	1.38	12.0	0.47	24	0.09	0.20
<b>16711-12-10ZF</b>	-12	11/16"x12	16	-10	73.5	2.89	39.5	1.56	12.0	0.47	30	0.12	0.26
<b>16711-16-12ZF</b>	-16	1 5/16"x12	20	-12	81.5	3.21	43.0	1.69	15.0	0.59	36	0.19	0.42

Braided – standard fittings

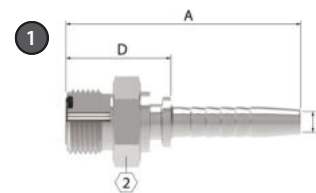

# 14211

Male ORS For use with hose: EC115, EC215 and EC118

PART 1 Part #	HOSE SIZE INFO				DIMENSIONS							WEIGHT	
	Terminal End	Thread	Hose Size		A		D Cut Off Factor		E Ø		1	Weight	
	Dash Size		DN	Dash Size	mm	in	mm	in	mm	in	mm	kg	lb
<b>14211-06-04ZF</b>	-06	11/16"-16	6	-04	52.0	2.05	24.0	0.94	3.9	0.15	19	0.04	0.08
<b>14211-06-06ZF</b>	-06	11/16"-16	10	-06	54.0	2.13	24.0	0.94	6.7	0.26	19	0.04	0.09
<b>14211-08-06ZF</b>	-08	13/16"-16	10	-06	57.5	2.26	27.5	1.08	7.0	0.28	22	0.06	0.13
<b>14211-08-08ZF</b>	-08	13/16"-16	12	-08	60.0	2.36	28.5	1.12	9.6	0.38	22	0.07	0.15
<b>14211-10-08ZF</b>	-10	1"-14	12	-08	64.0	2.52	32.5	1.28	10.0	0.39	27	0.11	0.24
<b>14211-12-10ZF</b>	-12	1 3/16"-12	16	-10	70.0	2.76	36.0	1.42	12.0	0.47	32	0.16	0.36
<b>14211-12-12ZF</b>	-12	1 3/16"-12	20	-12	75.0	2.95	36.5	1.44	15.0	0.59	32	0.17	0.38
<b>14211-16-12ZF</b>	-16	1 7/16"-12	20	-12	75.5	2.97	37.0	1.46	14.9	0.59	38	0.23	0.50

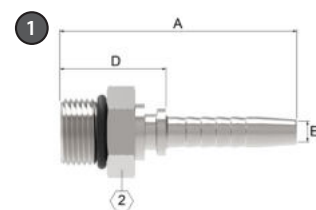

# 16011

Male Boss O-Ring For use with hose: EC115, EC215 and EC118

PART 1 Part #	HOSE SIZE INFO				DIMENSIONS							WEIGHT	
	Terminal End	Thread	Hose Size		A		D Cut Off Factor		E Ø		1	Weight	
	Dash Size		DN	Dash Size	mm	in	mm	in	mm	in	mm	kg	lb
<b>16011-06-04ZF</b>	-06	9/16"-18	6	-04	50.5	1.99	22.5	0.89	3.9	0.15	17	0.03	0.06
<b>16011-06-06ZF</b>	-06	9/16"-18	10	-06	52.5	2.07	22.5	0.89	6.9	0.27	17	0.03	0.07
<b>16011-08-06ZF</b>	-08	3/4"-16	10	-06	53.5	2.11	23.5	0.93	6.9	0.27	22	0.05	0.10
<b>16011-08-08ZF</b>	-08	3/4"-16	12	-08	55.5	2.19	24.0	0.94	9.9	0.39	22	0.06	0.12

# Winner

---

Weatherhead by Danfoss

## Spiral fittings







4S & 6S series















# Weatherhead

Hose to fitting chart

Match the  
to the spiral

Premium core hose:       
Standard core hose: 

4S series fittings (pg 169 - 222)			6S series fittings (pg 169 - 222)			1W series fittings (pg 223 - 226)		
For use with hoses:		See page:	For use with hoses:		See page:	For use with hoses:		See page:
H430		46	H471		49	H600		51
H430R		47	H810L		50	H464		60
H525H		48	H600		51	H850		59
H471		49	H850		59			
H810L		50	EC420		70			
H600		51						
H464		60						
H850		59						
EC415		69						
EC420		70						



## Numbering system - hose fittings



**4S12FJ12**

Product group code: **4S**

End connection size: **12**

End connection code: **FJ** (Female JIC Swivel)

Hose size: **12**

### Part numbering system

Part numbers collapse to the shortest possible number of digits:

It is assumed that a fitting has a straight configuration unless a code is added to designate otherwise.

e.g., ZA8FJ8 has a straight configuration  
ZA8FJA8 has a 45° elbow configuration

Dashes and unnecessary zeros are not used.

e.g., 1/4" is designated by "4" not "-4" or "04"  
5/8" is designated by "10" not "-10"

### Stainless steel fittings

A stainless steel version of many Danfoss fittings is available for use in the most demanding applications, such as those that are highly prone to corrosion or commonly exposed to corrosive chemicals. Stainless steel fittings use the Weatherhead fitting part numbering system with a material designation suffix of "C".

For more information, contact your support representative.

## Weatherhead premium spiral crimp fittings

- 4S** = 4S fitting part number for four spiral hose
- 6S** = 6S fitting part number for six spiral hose
- 1W** = Internal skive spiral part number

If material is round stock, then this position collapses.  
A = inch hex stock  
(metric hex, this position collapses)

- BF = BSP Female Swivel (1 hex)
- BJ = Banjo
- BP = BSP Male Parallel
- BT = BSP Male Tapered
- CT = Cat Flange
- DK = 24 Male (light duty)
- DL = DKO Female Swivel (light duty)
- DS = DKO Female Swivel (heavy duty)
- EK = 24 Male (heavy duty)
- FC = Female Snap to Connect (STC)
- FH = Flange Code 62
- FJ = Female JIC Swivel
- FL = Flange Code 61
- FP = Female Pipe Rigid
- FR = Female ORS
- FS = Female SAE Swivel
- JF = JIS Female Swivel
- JM = BSP Female Swivel (2 hexes)
- KF = Komatsu Female Swivel
- KS = Komatsu Split Flange
- MB = Male Boss O-Ring
- MC = Male Snap to Connect (STC)
- MF = Male Inverted Flare
- MJ = Male JIC
- MP = Male Pipe
- MR = Male ORS
- PF = Female Pipe Swivel
- PS = Pipe Swivel

If nipple has a straight configuration, then this position collapses.

- A = 45°
- B = 90°, standard or short drop
- C = 90°, long drop
- D = 22-1/2°
- E = 67-1/2°
- F = 30°
- G = 60°
- H = 110°

- C = stainless steel, if fitting is zinc plated carbon steel (standard), this position collapses.
- TZ = zinc nickel, if fitting is zinc plated carbon steel (standard), this position collapses.

\*When ordering sizes 3, 4, 5, 6 and 8 the part number requires only single digits.

# Weatherhead

## How to order

Accurate processing and prompt delivery of your order depends on easy identification of your requirements. Please order Danfoss brand parts using correct part numbers as described in this catalog. Inquiries and orders should be directed to your Danfoss Fluid Conveyance Distributor or:

**Danfoss**  
 14615 Lone Oak Rd.  
 Eden Prairie, MN 55344  
 1-952-937-9800  
 1-888-258-0222  
 Fax: 952-974-7722  
 www.Danfoss.com/hydraulics

### Part numbers and dash sizes

Dash size designates the nominal size of 16ths of an inch or tube O.D. in mm. This number immediately follows the part number and is separated from it with a dash.

### Dimensions

Dimensions given in this catalog for Danfoss products are approximate and should be used for reference only. Exact dimensional information for a given product is subject to change and varying tolerances; contact Danfoss directly for full current information.

### Globally standardized pressure ratings

Danfoss has standardized hose burst and operating pressure ratings in cataloging, worldwide. This move toward standardization will slightly alter some of the pressure ratings listed for hoses in this catalog as pressures are rounded off. This is a paper conversion only. This action has no effect on the actual testing and certification of Danfoss hoses to stringent product standards.

### Label Set - FF91420

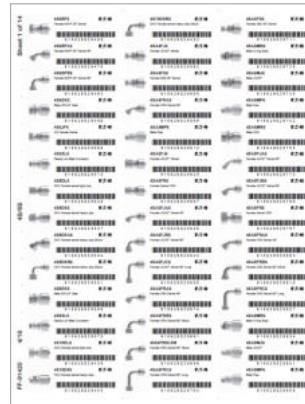

### Warning

#### Hose assemblies

Danfoss manufactures the terminal ends of our hose fittings to the appropriate requirements established by the SAE. Therefore, the performance ratings of these hose fittings meet or exceed the SAE requirements. It is possible to order a hose assembly with a fitting terminal end that has a performance rating lower than the hose rating.

When ordering hose assemblies, please keep the connecting end performance rating in mind since this may affect overall hose assembly performance. Hose assembly components (hose and fittings) are easily assembled in the field. However, factory assembled reusable and crimped hose assemblies are available. For complete information, contact Danfoss.

### Markings on crimp fittings

Use of correct Danfoss fitting with a given Danfoss hose is essential for proper assembly and performance. All Danfoss 4S/6S fittings are marked with the product group, 4S or 6S, and the dash size.

### Global identification marking

Global non-skive fitting sockets for four-spiral and six-spiral hose in all sizes have four or six rings plus a scribe mark and either 4S-size or 6S-size etched on the socket. Global hose fittings are identified with an Danfoss trademark and the hose dash size. In addition, global sockets are identified with the following:

Identification marking	Fitting style	Hose/Socket description
4 rings 1 scribe mark and 4S socket 4S-(size)	Spiral non-skive	Four spiral wire hose
6 rings 1 scribe mark and 6S socket 6S-(size)	Spiral non-skive	Six spiral wire hose

4S Fitting



4S Socket



6S Fitting



6S Socket



EXAMPLE: SAE JIC/37° Female Swivel – Straight for “4S” series	EXAMPLE: SAE Code 61 Flange – Straight for “6S” series
Danfoss global fitting part # 4SA12FJ16 (must order part using this part #)	Danfoss global fitting part # 6S32FL24 (must order part using this part #)
Weatherhead size reference # 16-612 (for reference only – cannot order part using this number) • Hose size: -16 • Fitting terminal end size & type: -612	Weatherhead size reference # 24-G32 (for reference only – cannot order part using this number) • Hose size: -24 • Fitting terminal end size & type: -G32
View of fitting section in catalog:	View of fitting section in catalog:
<b>4SA12FJ16 (16-612)</b>	<b>6S32FL24 (24-G32)</b>

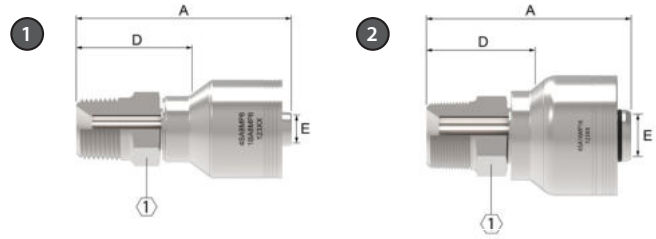

# MP

Male Pipe NPTF - Rigid (Straight)

PART	HOSE SIZE INFO				DIMENSIONS						
	Terminal End Hose Size	DN	Hose size	Thread	A		D		EØ		①
① 4S part #					mm	in	mm	in	mm	in	in
<b>4SA4MP6</b>	-4	6	-6	1/4	51.4	2.02	30.1	1.18	6.7	0.26	11/16
<b>4SA6MP6</b>	-6	10	-6	3/8	55	2.17	32.2	1.27	6.7	0.26	11/16
<b>4SA6MP8</b>	-6	10	-8	3/8	60.8	2.39	33.6	1.32	9.6	0.38	13/16
<b>4SA8MP6</b>	-8	12	-6	1/2	53.7	2.11	32.4	1.28	6.7	0.26	7/8
<b>4SA8MP8</b>	-8	12	-8	1/2	71	2.8	40.6	1.6	9.6	0.38	7/8
<b>4SA8MP10</b>	-8	12	-10	1/2	66.2	2.61	40.1	1.58	12.8	0.5	15/16
<b>4SA12MP8</b>	-12	19	-8	3/4	62.6	2.46	35.4	1.39	9.6	0.38	1 1/16
<b>4SA8MP12</b>	-8	19	-12	1/2	84,6	3.33	48,4	1.90	14,2	0.56	7/8
<b>4SA12MP12</b>	-12	19	-12	3/4	85,9	3.38	49,6	1.95	14,2	0.56	1 1/16
<b>4SA16MP12</b>	-16	19	-12	1-11 1/2	84,8	3.34	48,6	1.91	14,2	0.56	1 3/8
<b>4SA12MP16</b>	-12	25	-16	3/4	89,1	3.51	49,2	1.94	19,2	0.75	1 3/8
<b>4SA16MP16</b>	-16	25	-16	1-11 1/2	94,0	3.70	54,1	2.13	19,2	0.75	1 3/8
<b>4SA20MP16</b>	-20	25	-16	1 1/4-11 1/2	90,4	3.56	50,5	1.99	19,2	0.75	1 11/16
<b>4SA16MP20</b>	-16	31	-20	1-11 1/2	107,6	4.24	52,5	2.07	25,2	0.99	1 7/16
<b>4SA20MP20</b>	-20	31	-20	1 1/4-11 1/2	119,6	4.71	64,4	2.54	25,2	0.99	1 11/16
<b>4SA24MP24</b>	-24	38	-24	1 1/2-11 1/2	143,2	5.64	65,2	2.57	31,1	1.22	2
<b>4SA32MP32</b>	-32	51	-32	2-11 1/2	150,1	5.91	72,1	2.84	42,1	1.66	2 1/2
② 6S part #	Terminal End Hose Size	DN	Hose size	Thread	A		D		EØ		
<b>6SA16MP16</b>	-16	25	-16	1-11 1/2	94,0	3.70	54,1	2.13	19,2	0.75	1 3/8
<b>6SA20MP20</b>	-20	31	-20	1 1/4-11 1/2	120,4	4.74	64,4	2.54	25,2	0.99	1 11/16
<b>6SA24MP24</b>	-24	38	-24	1 1/2-11 1/2	143,2	5.64	65,2	2.57	31,1	1.22	2
<b>6SA32MP32</b>	-32	51	-32	2-11 1/2	150,1	5.91	72,1	2.84	42,1	1.66	2 1/2

**Weatherhead**

Spiral – 4S and 6S series

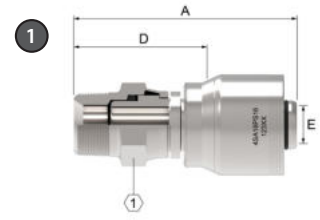
**PS**

Male Pipe NPTF - Swivel (Straight)

PART 4S part #	HOSE SIZE INFO				DIMENSIONS						
	Terminal End Hose Size	DN	Hose size	Thread	A		D		EØ		①
					mm	in	mm	in	mm	in	in
<b>4SA16PS16</b>	-16	25	-16	1 11 1/2	110,2	4.34	70,1	2.76	19,2	0.75	1 1/2

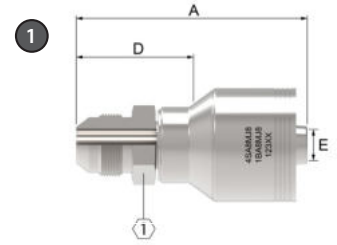

## MJ

Male JIC/37° - Rigid (Straight)

PART	HOSE SIZE INFO				DIMENSIONS						
	Terminal End Hose Size	DN	Hose size	Thread	A		D		EØ		1
1 4S part #					mm	in	mm	in	mm	in	in
4SA6MJ6	-6	10	-6	9/16	53,7	2,12	31	1,22	6,7	0,26	11/16
4SA8MJ6	-8	12	-6	3/4	49,4	1,94	28,1	1,11	6,7	0,26	13/16
4SA8MJ8	-8	12	-8	3/4	65,8	2,59	35,5	1,4	9,6	0,38	13/16
4SA10MJ8	-10	16	-8	7/8	59,1	2,33	31,9	1,26	9,6	0,38	15/16
4SA10MJ10	-10	16	-10	7/8	69,4	2,73	40,5	1,59	12,3	0,48	15/16
4SA12MJ8	-12	19	-8	1 1/16	63,4	2,5	36,2	1,43	9,6	0,38	1 1/8
4SA12MJ10	-12	19	-10	1 1/16	62,4	2,46	36,4	1,43	12,8	0,5	1 1/8
4SA10MJ12	-10	19	-12	7/8	84,3	3,32	48,2	1,90	12,3	0,48	15/16
4SA12MJ12	-12	19	-12	1 1/16	86,9	3,42	50,8	2,00	14,2	0,56	1 1/8
4SA14MJ12	-14	19	-12	1 3/16	83,1	3,27	47,0	1,85	14,2	0,56	1 1/4
4SA16MJ12	-16	19	-12	1 5/16	83,6	3,29	47,5	1,87	14,2	0,56	1 3/8
4SA16MJ16	-16	25	-16	1 5/16	93,7	3,69	54,0	2,13	19,2	0,75	1 3/8
4SA20MJ16	-20	25	-16	1 5/8	99,6	3,92	60,0	2,36	19,2	0,76	1 11/16
4SA20MJ20	-20	31	-20	1 5/8	115,7	4,56	60,5	2,38	25,2	0,99	1 11/16
4SA24MJ24	-24	38	-24	1 7/8	151,3	5,96	73,3	2,89	31,1	1,22	2
4SA32MJ32	-32	51	-32	2 1/2	163,8	6,45	85,8	3,38	42,1	1,66	2 5/8

See note below

When assembled with all Danfoss components, all SAE 37° JIC male and female terminal ends in the 4S & 6S product line are rated at the pressures listed in the table above and have passed one million impulse cycles at 133% of this pressure. All straight configurations achieve a 4:1 burst.

The 45° and 90° elbow configurations in the -12 size meet a 3.2:1 burst the 45° and 90° elbow configurations in the -16 size achieve a 2.8:1 burst; the 45° and 90° elbow configurations in the -20 size meet a 4:1 burst and the 45° & 90° elbow configurations in the -24 size meet a 2.4:1 burst.

# Weatherhead

Spiral – 4S and 6S series

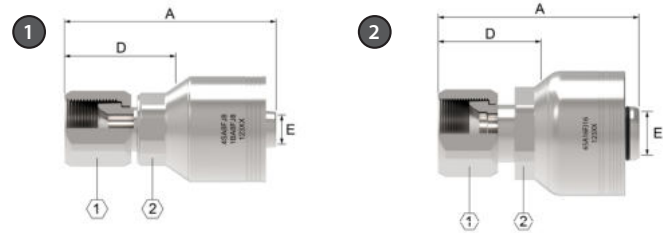

## FJ

Female JIC/37° swivel (Straight)

PART	HOSE SIZE INFO				DIMENSIONS								
	Terminal End Hose Size	DN	Hose size	Thread	A		D		EØ		1	2	
4S part #					mm	in	mm	in	mm	in	in	mm	in
4SA4FJ6	-4	6	-6	7/16	51.6	2.03	30.3	1.19	4.4	0.17	9/16		11/16
4SA6FJ6	-6	10	-6	9/16	53	2.09	32.2	1.27	6.7	0.26	11/16		11/16
4SA6FJ8	-6	10	-8	9/16	68.3	2.69	38	1.5	9.6	0.38	11/16		11/16
4SA8FJ6	-8	12	-6	3/4	54.8	2.16	34	1.34	6.7	0.26	7/8		11/16
4SA8FJ8	-8	12	-8	3/4	64.8	2.55	36.7	1.44	9.6	0.38	7/8		7/8
4SA10FJ8	-10	16	-8	7/8	66.1	2.6	40.6	1.6	12.8	0.5	1		1 1/16
4SA10FJ10	-10	16	-10	7/8	67.3	2.65	39.2	1.54	9.6	0.38	1		7/8
4SA12FJ8	-12	19	-8	1 1/4	67.1	2.64	41.5	1.63	12.8	0.5	1 1/4		1 1/16
4SA12FJ10	-12	19	-10	1 1/16	68.5	2.7	40.4	1.59	9.6	0.38	1 1/4		7/8
4SA10FJ12	-10	19	-12	7/8	75.0	2.95	38.8	1.53	12.3	0.48	1	30.0	1 3/16
4SA12FJ12	-12	19	-12	1 1/16	82.0	3.23	45.7	1.80	14.2	0.56	1 1/4	30.0	1 3/16
4SA14FJ12	-14	19	-12	1 3/16	77.5	3.05	41.3	1.63	14.2	0.56	1 3/8	30.0	1 3/16
4SA16FJ12	-16	19	-12	1 5/16	80.2	3.16	44.0	1.73	14.2	0.56	1 1/2	30.0	1 3/16
4SA12FJ16	-12	25	-16	1 1/16	78.8	3.10	39.1	1.54	15.5	0.61	1 1/4	41.0	1 5/8
4SA16FJ16	-16	25	-16	1 5/16	89.2	3.51	49.3	1.94	19.2	0.76	1 1/2	41.0	1 5/8
4SA20FJ16	-20	25	-16	1 5/8	85.8	3.38	46.0	1.81	19.2	0.76	2	41.0	1 5/8
4SA16FJ20	-16	31	-20	1 5/16	99.1	3.90	43.7	1.72	25.2	0.99	1 1/2	46.0	1 13/16
4SA20FJ20	-20	31	-20	1 5/8	101.6	4.00	46.3	1.82	25.2	0.99	2	46.0	1 13/16
4SA24FJ20	-24	31	-20	1 7/8	106.8	4.20	51.5	2.03	25.2	0.99	2 1/4	46.0	1 13/16
4SA24FJ24	-24	38	-24	1 7/8	134.9	5.31	56.8	2.24	31.1	1.22	2 1/4	57.0	2 1/4
4SA32FJ32	-32	51	-32	2 1/2	146.0	5.75	68.0	2.68	42.1	1.66	2 7/8		
6S part #	Terminal End Hose Size	DN	Hose size	Thread	A		D		EØ		1	2	
6SA16FJ16	-16	25	-16	1 5/16	89.2	3.51	49.3	1.94	19.2	0.76	1 1/2	41.0	1 5/8
6SA20FJ20	-20	31	-20	1 5/8	102.3	4.03	46.3	1.82	25.2	0.99	2	46.0	1 13/16
6SA24FJ20	-24	31	-20	1 7/8	107.5	4.23	51.5	2.03	25.2	0.99	2 1/4	46.0	1 13/16
6SA24FJ24	-24	38	-24	1 7/8	134.9	5.31	56.8	2.24	31.1	1.22	2 1/4	57.0	2 1/4
6SA32FJ32	-32	51	-32	2 1/2	146.0	5.75	68.0	2.68	42.1	1.66	2 7/8		

When assembled with all Danfoss components, all SAE 37° JIC male and female terminal ends in the 4S & 6S product line are rated at the pressures listed in the table above and have passed one million impulse cycles at 133% of this pressure. All straight configurations achieve a 4:1 burst.

The 45° and 90° elbow configurations in the -12 size meet a 3.2:1 burst the 45° and 90° elbow configurations in the -16 size achieve a 2.8:1 burst; the 45° and 90° elbow configurations in the -20 size meet a 4:1 burst and the 45° & 90° elbow configurations in the -24 size meet a 2.4:1 burst.

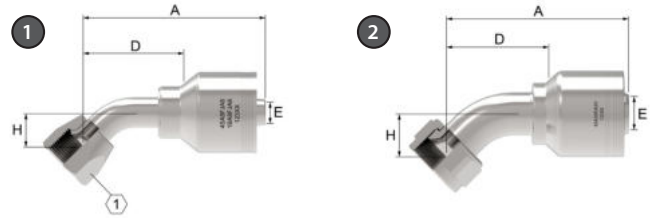

# FJA

Female JIC/37° swivel (45° elbow)

PART	HOSE SIZE INFO				DIMENSIONS								
	Terminal End Hose Size	DN	Hose size	Thread	A		D		EØ		H		1
4S part #					mm	in	mm	in	mm	in	mm	in	in
<b>4SA6FJA6</b>	-6	10	-6	9/16	56,5	2,22	33,3	1,31	6,2	0,24	9,9	0,39	11/16
<b>4SA8FJA6</b>	-8	12	-6	3/4	63,4	2,5	42,1	1,66	6,7	0,26	14	0,55	7/8
<b>4SA8FJA8</b>	-8	12	-8	3/4	72,9	2,87	42,7	1,68	9,4	0,37	14	0,55	7/8
<b>4SA10FJA8</b>	-10	16	-8	7/8	71,6	2,82	45,4	1,787	11,7	0,46	16	0,63	1
<b>4SA10FJA10</b>	-10	16	-10	7/8	82,5	3,25	55,3	2,18	9,4	0,37	25,3	1	1
<b>4SA12FJA10</b>	-12	19	-10	1 1/16	92,6	3,65	66,5	2,62	12,8	0,5	29,4	1,16	1 1/4
<b>4SA12FJA12</b>	-12	19	-12	1 1/16	112,3	4,42	76,1	3,00	14,2	0,56	29,0	1,14	1 1/4
<b>4SA16FJA12</b>	-16	19	-12	1 5/16	133,6	5,26	97,5	3,84	14,2	0,56	38,0	1,50	1 1/2
<b>4SA16FJA16</b>	-16	25	-16	1 5/16	128,8	5,07	89,3	3,52	19,2	0,76	38,0	1,50	1 1/2
<b>4SA20FJA16</b>	-20	25	-16	1 5/8	120,1	4,73	80,4	3,17	19,2	0,75	32,0	1,26	2
<b>4SA20FJA20</b>	-20	31	-20	1 5/8	135,6	5,34	80,4	3,17	25,2	0,99	32,0	1,26	2
<b>4SA24FJA24</b>	-24	38	-24	1 7/8	212,0	8,35	134,0	5,28	31,1	1,22	43,0	1,69	2 1/4
6S part #	Terminal End Hose Size	DN	Hose size	Thread	A		D		EØ				
<b>6SA20FJA20</b>	-20	31	-20	1 5/8	136,4	5,37	80,4	3,17	25,2	0,99	32,0	1,26	2
<b>6SA24FJA24</b>	-24	38	-24	1 7/8	212,0	8,35	134,0	5,28	31,1	1,22	43,0	1,69	2 1/4

See note below

When assembled with all Danfoss components, all SAE 37° JIC male and female terminal ends in the 4S & 6S product line are rated at the pressures listed in the table above and have passed one million impulse cycles at 133% of this pressure. All straight configurations achieve a 4:1 burst.

The 45° and 90° elbow configurations in the -12 size meet a 3.2:1 burst the 45° and 90° elbow configurations in the -16 size achieve a 2.8:1 burst; the 45° and 90° elbow configurations in the -20 size meet a 4:1 burst and the 45° & 90° elbow configurations in the -24 size meet a 2.4:1 burst.

# Weatherhead

Spiral – 4S and 6S series

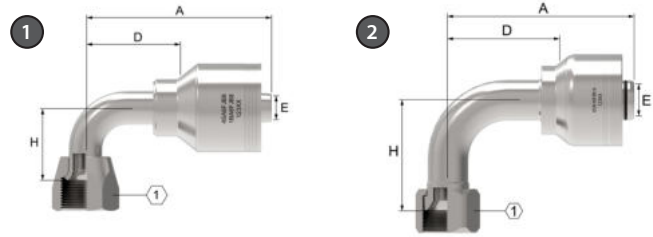

## FJB

Female JIC/37° swivel (90° elbow)

PART	HOSE SIZE INFO				DIMENSIONS								
	Terminal End Hose Size	DN	Hose size	Thread	A		D		EØ		H		1
4S part #					mm	in	mm	in	mm	in	mm	in	in
<b>4SA6FJB6</b>	-6	10	-6	9/16	54,1	2.13	30,9	1.22	6,2	0.24	21,6	0.85	11/16
<b>4SA8FJB6</b>	-8	12	-6	3/4	57,2	2.25	36,1	1.42	6,7	0.26	27,7	1.09	7/8
<b>4SA8FJB8</b>	-8	12	-8	3/4	67,1	2.64	36,7	1.44	9,4	0.37	27,7	1.09	7/8
<b>4SA10FJB8</b>	-10	16	-8	7/8	70,5	2.78	43,3	1.7	9,4	0.37	49	1.93	1
<b>4SA10FJB10</b>	-10	16	-10	7/8	70,2	2.76	39,3	1.55	11,7	0.46	31,2	1.23	1
<b>4SA12FJB10</b>	-12	19	-10	1 1/16	81,4	3.2	55,4	2.18	12,8	0.5	59,7	2.35	1 1/4
<b>4SA12FJB12</b>	-12	19	-12	1 1/16	101,3	3.99	65,3	2.57	14,2	0.56	58,0	2.28	1 1/4
<b>4SA16FJB12</b>	-16	19	-12	1 5/16	110,0	4.33	73,8	2.91	14,2	0.56	71,0	2.80	1 1/2
<b>4SA16FJB16</b>	-16	25	-16	1 5/16	113,1	4.45	73,5	2.89	19,2	0.76	71,0	2.80	1 1/2
<b>4SA20FJB16</b>	-20	25	-16	1 5/8	117,1	4.61	77,4	3.05	19,2	0.75	78,0	3.07	2
<b>4SA20FJB20</b>	-20	31	-20	1 5/8	132,6	5.22	77,4	3.05	25,2	0.99	78,0	3.07	2
<b>4SA24FJB24</b>	-24	38	-24	1 7/8	208,9	8.22	130,8	5.15	31,1	1.22	104,0	4.09	2 1/4
6S part #	Terminal End Hose Size	DN	Hose size	Thread	A		D		EØ		H		1
<b>6SA16FJB16</b>	-16	25	-16	1 5/16	113,1	4.45	73,5	2.89	19,0	0.75	71,0	2.80	1 1/2
<b>6SA20FJB20</b>	-20	31	-20	1 5/8	133,4	5.25	77,4	3.05	25,2	0.99	78,0	3.07	2
<b>6SA24FJB24</b>	-24	38	-24	1 7/8	208,9	8.22	130,8	5.15	31,1	1.22	104,0	4.09	2 1/4

See note below

When assembled with all Danfoss components, all SAE 37° JIC male and female terminal ends in the 4S & 6S product line are rated at the pressures listed in the table above and have passed one million impulse cycles at 133% of this pressure. All straight configurations achieve a 4:1 burst.

The 45° and 90° elbow configurations in the -12 size meet a 3.2:1 burst the 45° and 90° elbow configurations in the -16 size achieve a 2.8:1 burst; the 45° and 90° elbow configurations in the -20 size meet a 4:1 burst and the 45° & 90° elbow configurations in the -24 size meet a 2.4:1 burst.



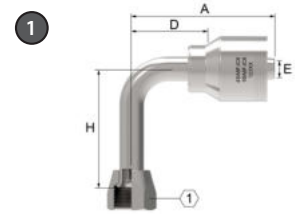

# FJC

Female JIC/37° swivel (90° Elbow - Long Drop)

PART ① 4S part #	HOSE SIZE INFO				DIMENSIONS								
	Terminal End Hose Size	DN	Hose size	Thread	A		D		EØ		H		①
					mm	in	mm	in	mm	in	mm	in	in
<b>4SA6FJC6</b>	-6	10	-6	9/16	54,1	2.13	30,9	1.21	6,2	0.24	55,4	2.18	11/16
<b>4SA8FJC8</b>	-8	12	-8	3/4	70,5	2.78	39,9	1.57	9,4	0.37	61,7	2.43	7/8
<b>4SA12FJC12</b>	-12	19	-12	1 1/16	101,3	3.99	65,3	2.57	14,2	0.56	96,0	3.78	1 1/4
<b>4SA16FJC16</b>	-16	25	-16	1 5/16	112,5	4.43	73,5	2.89	19,0	0.75	114,0	4.49	1 1/2
<b>4SA20FJC20</b>	-20	31	-20	1 5/8	132,6	5.22	77,4	3.05	25,2	0.99	129,0	5.08	2

See note below

When assembled with all Danfoss components, all SAE 37° JIC male and female terminal ends in the 4S & 6S product line are rated at the pressures listed in the table above and have passed one million impulse cycles at 133% of this pressure. All straight configurations achieve a 4:1 burst.

The 45° and 90° elbow configurations in the -12 size meet a 3.2:1 burst the 45° and 90° elbow configurations in the -16 size achieve a 2.8:1 burst; the 45° and 90° elbow configurations in the -20 size meet a 4:1 burst and the 45° & 90° elbow configurations in the -24 size meet a 2.4:1 burst.

## Weatherhead

Spiral – 4S and 6S series

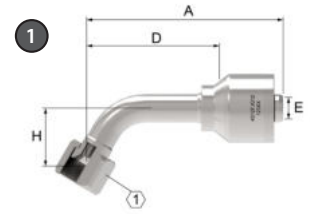

## FJG

Female JIC/37° - swivel (60° elbow)

PART 4S part #	HOSE SIZE INFO				DIMENSIONS								
	Terminal End Hose Size	DN	Hose size	Thread	A		D		EØ		H		①
					mm	in	mm	in	mm	in	mm	in	in
<b>4SA12FJG12</b>	-12	19	-12	1 1/16	127,0	5.00	90,8	3.58	14,2	0.56	38,9	1.53	1 1/4
<b>4SA16FJG16</b>	-16	25	-16	1 5/16	144,4	5.69	104,8	4.12	19,2	0.76	47,6	1.87	1 1/2

See note below

When assembled with all Danfoss components, all SAE 37° JIC male and female terminal ends in the 4S & 6S product line are rated at the pressures listed in the table above and have passed one million impulse cycles at 133% of this pressure. All straight configurations achieve a 4:1 burst.

The 45° and 90° elbow configurations in the -12 size meet a 3.2:1 burst; the 45° and 90° elbow configurations in the -16 size achieve a 2.8:1 burst; the 45° and 90° elbow configurations in the -20 size meet a 4:1 burst and the 45° & 90° elbow configurations in the -24 size meet a 2.4:1 burst.

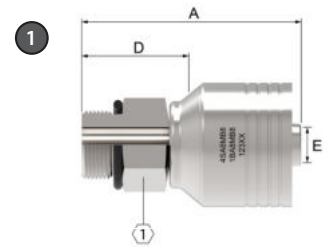

# MB

Male O-ring boss - Rigid (Straight)

PART	HOSE SIZE INFO				DIMENSIONS						
	Terminal End Hose Size	DN	Hose size	Thread	A		D		EØ		1
1 4S part #					mm	in	mm	in	mm	in	mm
<b>4SA8MB8</b>	-8	12	-8	3/4	57,4	2.26	30,1	1.19	9,6	0.38	7/8
<b>4SA12MB12</b>	-12	19	-12	1 1/16	78,7	3.10	42,5	1.67	14,2	0.56	1 1/4
<b>4SA16MB16</b>	-16	25	-16	1 5/16	88,1	3.47	48,5	1.91	19,2	0.76	1 1/2
<b>4SA20MB20</b>	-20	31	-20	1 5/8	109,5	4.31	54,4	2.14	25,2	0.99	1 7/8
<b>4SA24MB24</b>	-24	38	-24	1 7/8	134,1	5.28	56,0	2.21	31,1	1.22	2 1/8

# Weatherhead

Spiral – 4S and 6S series

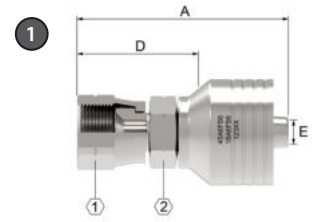

## FS

Female SAE 45° flare swivel (straight)

PART 4S part #	HOSE SIZE INFO				DIMENSIONS							
	Terminal End Hose Size	DN	Hose size	Thread	A		D		EØ		1	2
					mm	in	mm	in	mm	in	in	in
<b>4SA12FS12</b>	-12	19	-12	1 1/16	61,5	2.42	25,4	1.00	14,2	0.56	1 1/4	1 3/16

Spiral – 4S and 6S series



# MR

Male ORS - rigid (straight)

PART 4S part #	HOSE SIZE INFO				DIMENSIONS							
	Terminal End Hose Size	DN	Hose size	Thread	A		D		EØ		1	
					mm	in	mm	in	mm	in	in	
<b>4SA8MR8</b>	-8	12	-8	13/16	64,4	2,54	33,9	1,34	9,6	0,38	7/8	
<b>4SA12MR12</b>	-12	19	-12	1 3/16	80,8	3,18	44,4	1,75	14,2	0,56	1 1/4	
<b>4SA16MR12</b>	-16	19	-12	1 7/16	78,2	3,08	41,9	1,65	14,2	0,56	1 1/2	
<b>4SA16MR16</b>	-16	25	-16	1 7/16	87,7	3,45	47,9	1,89	19,2	0,76	1 1/2	
<b>4SA20MR16</b>	-20	25	-16	1 11/16	81,1	3,19	41,5	1,63	19,2	0,76	1 3/4	
<b>4SA20MR20</b>	-20	31	-20	1 11/16	107,1	4,22	52,0	2,05	25,2	0,99	1 3/4	

# Weatherhead

Spiral – 4S and 6S series

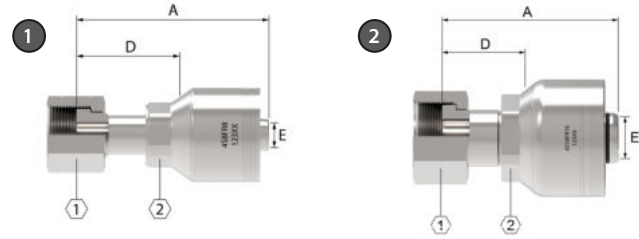

## FR

Female ORS swivel (straight)

PART	HOSE SIZE INFO				DIMENSIONS								
	Terminal End Hose Size	DN	Hose size	Thread	A		D		EØ		1	2	
4S part #					mm	in	mm	in	mm	in	in	mm	in
<b>4SA6FR6</b>	-6	10	-6	11/16	52,7	2,07	31,4	1,24	6,7	0,26	13/16		11/16
<b>4SA6FR8</b>	-6	10	-8	11/16	61,3	2,41	34,1	1,34	6,7	0,26	13/16		7/8
<b>4SA8FR6</b>	-8	12	-6	13/16	54,4	2,14	33,6	1,32	6,7	0,26	15/16		11/16
<b>4SA8FR8</b>	-8	12	-8	13/16	66,2	2,61	38,1	1,5	9,1	0,36	15/16		7/8
<b>4SA8FR8</b>	-8	12	-8	13/16	66,2	2,61	38,1	1,5	9,1	0,36	1 1/8		7/8
<b>4SA10FR10</b>	-10	16	-10	1	66,5	2,62	40,8	1,61	11,5	0,45	1 1/8		1 1/16
<b>4SA10FR10</b>	-10	16	-10	1	66,5	2,62	40,8	1,61	11,5	0,45	1 3/8		7/8
<b>4SA12FR10</b>	-12	19	-10	1 3/16	67,2	2,65	41,5	1,63	12,8	0,5	1 3/8		1 1/16
<b>4SA10FR12</b>	-10	19	-12	1	74,4	2,93	38,1	1,50	14,2	0,56	1 1/8	30,0	1 3/16
<b>4SA12FR12</b>	-12	19	-12	1 3/16	77,4	3,05	41,2	1,62	14,2	0,56	1 3/8	30,0	1 3/16
<b>4SA16FR12</b>	-16	19	-12	1 7/16	79,2	3,12	43,1	1,70	14,2	0,56	1 5/8	30,0	1 3/16
<b>4SA12FR16</b>	-12	25	-16	1 3/16	80,5	3,17	40,8	1,61	19,2	0,76	1 3/8	41,0	1 5/8
<b>4SA16FR16</b>	-16	25	-16	1 7/16	82,4	3,24	42,6	1,68	19,2	0,76	1 5/8	41,0	1 5/8
<b>4SA20FR16</b>	-20	25	-16	1 11/16	82,4	3,24	42,7	1,68	19,2	0,76	1 7/8	41,0	1 5/8
<b>4SA20FR20</b>	-20	31	-20	1 11/16	99,0	3,90	43,8	1,72	25,2	0,99	1 7/8	46,0	1 13/16
<b>4SA24FR24</b>	-24	38	-24	2	125,7	4,95	47,6	1,87	31,1	1,22	2 1/4	57,0	2 1/4
6S part #	Terminal End Hose Size	DN	Hose size	Thread	A		D		EØ		1	2	
<b>6SA16FR16</b>	-16	25	-16	1 7/16	82,4	3,24	42,6	1,68	19,2	0,76	1 5/8	41,0	1 5/8
<b>6SA20FR16</b>	-20	25	-16	1 11/16	82,4	3,24	42,7	1,68	19,2	0,76	1 7/8	41,0	1 5/8
<b>6SA20FR20</b>	-20	31	-20	1 11/16	99,8	3,93	43,8	1,72	25,2	0,99	1 7/8	46,0	1 13/16
<b>6SA24FR24</b>	-24	38	-24	2	125,7	4,95	47,6	1,87	31,1	1,22	2 1/4	57,0	2 1/4

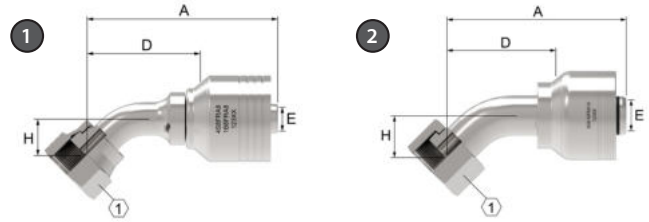

# FRA

Female ORS swivel (45° elbow)

PART	HOSE SIZE INFO				DIMENSIONS								
	Terminal End Hose Size	DN	Hose size	Thread	A		D		EØ		H		①
① 4S part #					mm	in	mm	in	mm	in	mm	in	in
<b>4SA6FRA6</b>	-6	10	-6	11/16	59,9	2.36	36,3	1.43	6,2	0.24	10,9	0.43	13/16
<b>4SA8FRA6</b>	-8	12	-6	13/16	65,6	2.58	44,3	1.74	6,7	0.26	15	0.59	15/16
<b>4SA8FRA8</b>	-8	12	-8	13/16	76,1	3	45,5	1.79	8,5	0.33	15	0.59	15/16
<b>4SA10FRA8</b>	-10	16	-8	1	78,3	3.08	51,1	2.01	9,6	0.38	16,5	0.65	1 1/8
<b>4SA10FRA10</b>	-10	16	-10	1	80,9	3.18	51,3	2.02	11	0.44	16,5	0.65	1 1/8
<b>4SA12FRA12</b>	-12	19	-12	1 3/16	108,7	4.28	72,5	2.85	14,2	0.56	24,0	0.94	1 3/8
<b>4SA16FRA12</b>	-16	19	-12	1 7/16	119,9	4.72	83,7	3.30	14,2	0.56	28,0	1.10	1 5/8
<b>4SA16FRA16</b>	-16	25	-16	1 7/16	112,8	4.44	73,0	2.87	19,2	0.76	28,0	1.10	1 5/8
<b>4SA20FRA16</b>	-20	25	-16	1 11/16	136,7	5.38	97,0	3.82	19,2	0.76	31,0	1.22	1 7/8
<b>4SA20FRA20</b>	-20	31	-20	1 11/16	153,4	6.04	98,1	3.86	25,2	0.99	31,0	1.22	1 7/8
<b>4SA24FRA24</b>	-24	38	-24	2	212,0	8.35	134,0	5.28	31,1	1.22	43,0	1.69	2 1/4
② 6S part #	Terminal End Hose Size	DN	Hose size	Thread	A		D		EØ		H		①
<b>6SA16FRA16</b>	-16	25	-16	1 7/16	112,8	4.44	73,0	2.87	19,2	0.76	28,0	1.10	1 5/8
<b>6SA20FRA16</b>	-20	25	-16	1 11/16	136,7	5.38	97,0	3.82	19,2	0.76	31,0	1.22	1 7/8
<b>6SA20FRA20</b>	-20	31	-20	1 11/16	154,1	6.07	98,1	3.86	25,2	0.99	31,0	1.22	1 7/8
<b>6SA24FRA24</b>	-24	38	-24	2	212,0	8.35	134,0	5.28	31,1	1.22	43,0	1.69	2 1/4

# Weatherhead

Spiral – 4S and 6S series

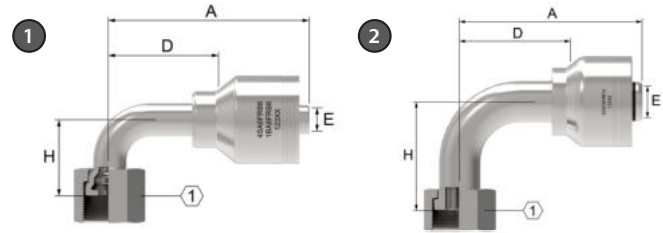

## FRB

Female ORS swivel (90° elbow)

PART	HOSE SIZE INFO				DIMENSIONS								
	Terminal End Hose Size	DN	Hose size	Thread	A		D		EØ		H		①
① 4S part #					mm	in	mm	in	mm	in	mm	in	in
<b>4SA6FRB6</b>	-6	10	-6	11/16	57.6	2.27	34.1	1.34	6.2	.24	22.9	.9	13/16
<b>4SA8FRB6</b>	-8	12	-6	13/16	62.5	2.46	41.2	1.62	6.7	.26	29.2	1.15	15/16
<b>4SA8FRB8</b>	-8	12	-8	13/16	73	2.87	42.4	1.67	8.5	.33	29.2	1.15	15/16
<b>4SA10FRB8</b>	-10	16	-8	1	75.6	2.98	48.4	1.91	9.6	.38	32.3	1.27	1 1/8
<b>4SA10FRB10</b>	-10	16	-10	1	78.3	3.08	48.6	1.91	11	.44	32.3	1.27	1 1/8
<b>4SA12FRB10</b>	-12	19	-10	1 3/16	84.2	3.31	58.1	2.29	12	.47	47.8	1.88	1 3/8
<b>4SA10FRB12</b>	-10	19	-12	1	91,5	3.60	55,3	2.18	14,2	0.56	32,3	1.27	1 1/8
<b>4SA12FRB12</b>	-12	19	-12	1 3/16	104,4	4.11	68,1	2.68	14,2	0.56	58,0	2.28	1 3/8
<b>4SA16FRB12</b>	-16	19	-12	1 7/16	117,1	4.61	80,9	3.19	14,2	0.56	71,0	2.80	1 5/8
<b>4SA12FRB16</b>	-12	25	-16	1 3/16	107,5	4.23	67,7	2.67	19,2	0.76	58,0	2.28	1 3/8
<b>4SA16FRB16</b>	-16	25	-16	1 7/16	112,8	4.44	73,0	2.87	19,2	0.76	71,0	2.80	1 5/8
<b>4SA20FRB16</b>	-20	25	-16	1 11/16	136,5	5.37	96,8	3.81	19,2	0.76	78,0	3.07	1 7/8
<b>4SA20FRB20</b>	-20	31	-20	1 11/16	153,1	6.03	97,9	3.85	25,2	0.99	78,0	3.07	1 7/8
<b>4SA24FRB20</b>	-24	31	-20	2	152,9	6.02	97,9	3.85	25,2	0.99	86,0	3.39	2 1/4
<b>4SA24FRB24</b>	-24	38	-24	2	208,9	8.22	130,8	5.15	31,1	1.22	104,0	4.09	2 1/4
② 6S part #	Terminal End Hose Size	DN	Hose size	Thread	A		D		EØ		H		①
<b>6SA16FRB16</b>	-16	25	-16	1 7/16	112,8	4.44	73,0	2.87	19,2	0.76	71,0	2.80	1 5/8
<b>6SA20FRB16</b>	-20	25	-16	1 11/16	136,5	5.37	96,8	3.81	19,2	0.76	78,0	3.07	1 7/8
<b>6SA20FRB20</b>	-20	31	-20	1 11/16	153,9	6.06	97,9	3.85	25,2	0.99	78,0	3.07	1 7/8
<b>6SA24FRB24</b>	-24	38	-24	2	208,9	8.22	130,8	5.15	31,1	1.22	104,0	4.09	2 1/4



Spiral – 4S and 6S series

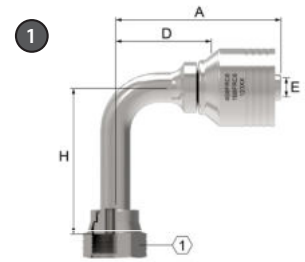

## FRC

Female ORS swivel (90° elbow - long drop)

PART ① 4S part #	HOSE SIZE INFO				DIMENSIONS								
	Terminal End Hose Size	DN	Hose size	Thread	A		D		EØ		H		①
					mm	in	mm	in	mm	in	mm	in	in
<b>4SA6FRC6</b>	-6	10	-6	11/16	57,6	2.27	34,1	1.34	6,2	.24	54,1	2.13	13/16
<b>4SA8FRC8</b>	-8	12	-8	13/16	73	2.87	42,4	1.67	8,5	.33	62,8	2.51	15/16
<b>4SA10FRC10</b>	-10	16	-10	1	78,3	3.08	48,6	1.91	11	.44	70,1	2.76	1 1/8
<b>4SA10FRC12</b>	-10	19	-12	1	91,5	3.60	55,3	2.18	14,2	0.56	70,0	2.76	1 1/8
<b>4SA12FRC12</b>	-12	19	-12	1 3/16	104,4	4.11	68,0	2.68	14,2	0.56	96,0	3.78	1 3/8
<b>4SA16FRC12</b>	-16	19	-12	1 7/16	117,1	4.61	80,9	3.19	14,2	0.56	114,0	4.49	1 5/8
<b>4SA16FRC16</b>	-16	25	-16	1 7/16	112,8	4.44	73,0	2.87	19,2	0.76	114,0	4.49	1 5/8
<b>4SA20FRC20</b>	-20	31	-20	1 11/16	152,9	6.02	97,9	3.85	25,2	0.99	129,0	5.08	1 7/8
<b>4SA24FRC20</b>	-24	31	-20	2	152,9	6.02	97,9	3.85	25,2	0.99	141,0	5.55	2 1/4
<b>4SA24FRC24</b>	-24	38	-24	2	152,9	6.02	97,9	3.85	25,2	0.99	141,0	5.55	2 1/4

# Weatherhead

Spiral – 4S and 6S series

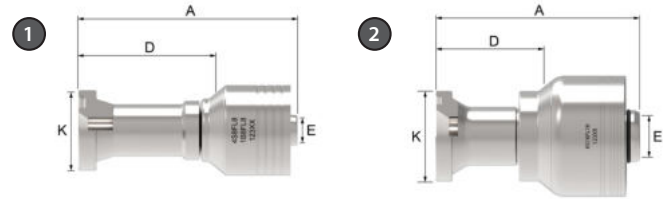

## FL

SAE Code 61 Flange (straight)

PART	HOSE SIZE INFO			DIMENSIONS							
	Terminal End Hose Size	DN	Hose size	Flange Head Dia. K Ø		A		D		E Ø	
1 4S part #				mm	in	mm	in	mm	in	mm	in
4S8FL8	-8	12	-8	79,5	3.13	52,3	2.06	9,6	.38	30,2	1.19
4S12FL8	-12	19	-8	80,6	3.17	53,3	2.1	9,6	.38	38,1	1.5
4S12FL12	-12	19	-12	38,1	1.50	90,7	3.57	54,5	2.15	14,2	0.56
4S16FL12	-16	19	-12	44,5	1.75	90,2	3.55	54,0	2.13	14,2	0.56
4S20FL12	-20	19	-12	50,8	2.00	97,7	3.85	61,5	2.42	14,2	0.56
4S16FL16	-16	25	-16	44,5	1.75	93,3	3.67	53,6	2.11	19,2	0.76
4S20FL16	-20	25	-16	50,8	2.00	100,8	3.97	61,1	2.41	19,2	0.76
4S24FL16	-24	25	-16	60,4	2.38	97,4	3.83	57,7	2.27	19,2	0.76
4S16FL20	-16	31	-20	44,5	1.75	110,5	4.35	55,5	2.18	25,2	0.99
4S20FL20	-20	31	-20	50,8	2.00	117,4	4.62	62,2	2.45	25,2	0.99
4S24FL20	-24	31	-20	60,4	2.38	106,7	4.20	51,6	2.03	25,2	0.99
4S32FL20	-32	31	-20	71,4	2.81	104,9	4.13	49,9	1.96	25,2	0.99
4S24FL24	-24	38	-24	60,4	2.38	171,6	6.75	93,6	3.68	31,1	1.22
4S32FL24	-32	38	-24	71,4	2.81	174,7	6.88	96,7	3.81	31,1	1.22
4S32FL32	-32	51	-32	71,4	2.81	177,5	6.99	99,5	3.92	42,1	1.66
2 6S part #	Terminal End Hose Size	DN	Hose size	Flange Head Dia. K Ø		A		D		E Ø	
6S16FL16	-16	25	-16	44,5	1.75	93,3	3.67	53,6	2.11	19,2	0.76
6S20FL20	-20	31	-20	50,8	2.00	118,2	4.65	62,2	2.45	25,2	0.99
6S24FL24	-24	38	-24	60,4	2.38	171,6	6.75	93,6	3.68	31,1	1.22
6S32FL24	-32	38	-24	71,4	2.81	174,7	6.88	96,7	3.81	31,1	1.22
6S32FL32	-32	51	-32	71,4	2.81	177,5	6.99	99,5	3.92	42,1	1.66

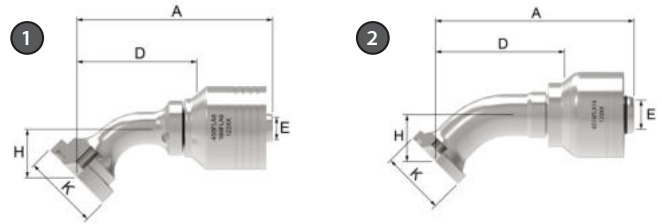

# FLA

SAE Code 61 Flange (45° elbow )

PART	HOSE SIZE INFO			DIMENSIONS									
	Terminal End Hose Size	DN	Hose size	Flange Head Dia. K Ø		A		D		E Ø		H	
mm	mm	mm	mm	mm	in	mm	in	mm	in	mm	in	mm	in
<b>1</b> 4S part #													
<b>4S8FLA8</b>	-8	12	-8	77,5	3,05	50,3	1,98	9,1	.36	19,8	.78	30,2	1,19
<b>4S12FLA8</b>	-12	19	-8	90,6	3,57	63,4	2,5	9,6	.38	25,4	1	38,1	1,5
<b>4S12FLA12</b>	-12	19	-12	38,1	1,50	113,8	4,48	77,6	3,06	14,2	0,56	27,0	1,06
<b>4S16FLA12</b>	-16	19	-12	44,4	1,75	127,9	5,04	91,7	3,61	14,2	0,56	32,0	1,26
<b>4S12FLA16</b>	-12	25	-16	38,1	1,50	116,9	4,60	77,2	3,04	19,2	0,76	27,0	1,06
<b>4S16FLA16</b>	-16	25	-16	44,4	1,75	131,0	5,16	91,3	3,59	19,2	0,76	32,0	1,26
<b>4S20FLA16</b>	-16	31	-20	44,4	1,75	152,1	5,99	97,0	3,82	25,2	0,99	32,0	1,26
<b>4S16FLA20</b>	-20	25	-16	50,8	2,00	150,2	5,91	110,5	4,35	19,2	0,76	39,0	1,54
<b>4S20FLA20</b>	-20	31	-20	50,8	2,00	166,8	6,57	111,6	4,39	25,2	0,99	39,0	1,54
<b>4S24FLA20</b>	-24	31	-20	60,4	2,38	161,6	6,36	106,6	4,20	25,2	0,99	39,5	1,34
<b>4S24FLA24</b>	-24	38	-24	60,3	2,37	214,3	8,44	136,3	5,37	31,1	1,22	45,0	1,77
<b>4S32FLA24</b>	-32	38	-24	71,4	2,81	251,0	9,88	173,0	6,81	31,1	1,22	57,5	2,26
<b>4S32FLA32</b>	-32	51	-32	71,4	2,81	253,9	10,00	175,9	6,92	42,1	1,66	57,5	2,26
<b>2</b> 6S part #													
<b>6S16FLA16</b>	-16	25	-16	44,4	1,75	131,0	5,16	91,3	3,59	19,2	0,76	32,0	1,26
<b>6S20FLA16</b>	-20	25	-16	50,8	2,00	150,2	5,91	110,5	4,35	19,2	0,76	39,0	1,54
<b>6S20FLA20</b>	-20	31	-20	50,8	2,00	167,6	6,60	111,6	4,39	25,2	0,99	39,0	1,54
<b>6S24FLA24</b>	-24	38	-24	60,3	2,37	214,3	8,44	136,3	5,37	31,1	1,22	45,0	1,77
<b>6S32FLA24</b>	-32	38	-24	71,4	2,81	251,0	9,88	173,0	6,81	31,1	1,22	57,5	2,26
<b>6S32FLA32</b>	-32	51	-32	71,4	2,81	253,9	10,00	175,9	6,92	42,1	1,66	57,5	2,26

# Weatherhead

Spiral – 4S and 6S series

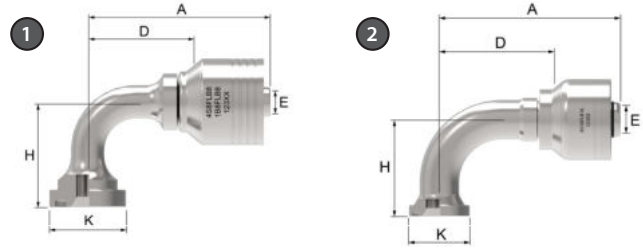

## FLB

SAE Code 61 Flange (90° elbow)

PART		HOSE SIZE INFO			DIMENSIONS									
1 4S part #	Terminal End Hose Size	DN	Hose size	Flange Head Dia. K Ø		A		D		E Ø		H		
				mm	in	mm	in	mm	in	mm	in	mm	in	
4S8FLB8	-8	12	-8	69,5	2.74	42,3	1.67	9,1	.36	41,4	1.63	30,2	1.19	
4S12FLB8	-12	19	-8	85,1	3.35	57,9	2.28	9,6	.38	54,1	2.13	38,1	1.5	
4S12FLB12	-12	19	-12	38,1	1.50	108,5	4.27	72,3	2.85	14,2	0.56	59,0	2.32	
4S16FLB12	-16	19	-12	44,4	1.75	122,8	4.84	86,6	3.41	14,2	0.56	71,0	2.80	
4S20FLB12	-20	19	-12	50,8	2.00	108,5	4.72	72,3	2.85	14,2	0.56	65,0	2.56	
4S16FLB16	-16	25	-16	44,4	1.75	126,0	4.96	86,2	3.39	19,2	0.76	71,0	2.80	
4S16FLB16.116	-16	25	-16	44,4	1.75	126,0	4.96	86,2	3.39	19,2	0.76	116,0	4.57	
4S20FLB16	-20	25	-16	50,8	2.00	145,2	5.72	105,4	4.15	19,2	0.76	89,0	3.50	
4S24FLB16	-24	25	-16	60,4	2.38	136,5	5.37	96,8	3.81	19,2	0.76	81,9	3.22	
4S16FLB20	-16	31	-20	44,4	1.75	147,1	5.79	91,9	3.62	25,2	0.99	71,0	2.80	
4S20FLB20	-20	31	-20	50,8	2.00	161,8	6.37	106,5	4.19	25,2	0.99	89,0	3.50	
4S24FLB20	-24	31	-20	60,4	2.38	152,9	6.02	97,9	3.85	25,2	0.99	81,9	3.22	
4S24FLB24	-24	38	-24	60,3	2.37	208,9	8.22	130,9	5.15	31,1	1.22	104,0	4.09	
4S32FLB24	-32	38	-24	71,4	2.81	247,4	9.74	169,4	6.67	31,1	1.22	138,0	5.43	
4S32FLB32	-32	51	-32	71,4	2.81	250,3	9.85	172,2	6.78	42,1	1.66	138,0	5.43	
2 6S part #	Terminal End Hose Size	DN	Hose size	Flange Head Dia. K Ø		A		D		E Ø		H		
6S16FLB16	-16	25	-16	44,4	1.75	126,0	4.96	86,2	3.39	19,2	0.76	71,0	2.80	
6S20FLB16	-20	25	-16	50,8	2.00	145,2	5.72	105,4	4.15	19,2	0.76	89,0	3.50	
6S20FLB20	-20	31	-20	50,8	2.00	162,5	6.40	106,5	4.19	25,2	0.99	89,0	3.50	
6S24FLB24	-24	38	-24	60,3	2.37	208,8	8.22	130,8	5.15	31,1	1.22	104,0	4.09	
6S32FLB24	-32	38	-24	71,4	2.81	247,4	9.74	169,4	6.67	31,1	1.22	138,0	5.43	
6S32FLB32	-32	51	-32	71,4	2.81	250,3	9.85	172,2	6.78	42,1	1.66	138,0	5.43	

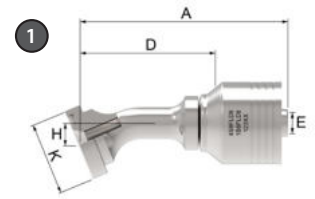

# FLD

SAE Code 61 Flange (22.5° elbow)

PART 4S part #	HOSE SIZE INFO			DIMENSIONS									
	Terminal End Hose Size	DN	Hose size	Flange Head Dia. K Ø		A		D		EØ		H	
				mm	in	mm	in	mm	in	mm	in	mm	in
<b>4S12FLD12</b>	-12	19	-12	38,1	1.50	121,3	4.78	85,1	3.35	14,2	0.56	11,6	0.46
<b>4S16FLD12</b>	-16	25	-12	44,4	1.75	136,7	5.38	100,5	3.96	14,2	0.56	13,5	0.53
<b>4S16FLD16</b>	-16	25	-16	44,4	1.75	139,8	5.50	100,1	3.94	19,2	0.76	13,5	0.53
<b>4S20FLD16</b>	-20	25	-16	50,8	2.00	160,9	6.33	121,2	4.77	19,2	0.76	16,3	0.64
<b>4S20FLD20</b>	-20	31	-20	50,8	2.00	177,3	6.98	122,3	4.81	25,2	0.99	16,3	0.64
<b>4S24FLD20</b>	-24	31	-20	60,4	2.38	173,6	6.83	117,6	4.63	25,2	0.99	17,1	0.67
<b>4S24FLD24</b>	-24	38	-24	60,3	2.37	226,4	8.91	148,4	5.84	31,1	1.22	18,8	0.74
<b>4S32FLD24</b>	-32	38	-24	71,4	2.81	266,7	10.50	188,7	7.43	31,1	1.22	23,5	0.93
<b>4S32FLD32</b>	-32	51	-32	71,4	2.81	269,6	10.61	191,5	7.54	42,1	1.66	23,5	0.93

# Weatherhead

Spiral – 4S and 6S series

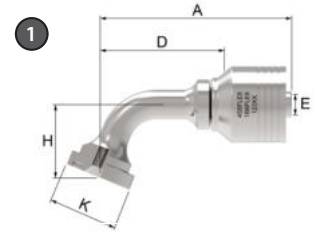

## FLE

SAE Code 61 Flange (67.5° elbow)

PART	HOSE SIZE INFO			DIMENSIONS									
	Terminal End Hose Size	DN	Hose size	Flange Head Dia. K Ø		A		D		EØ		H	
1 4S part #				mm	in	mm	in	mm	in	mm	in	mm	in
<b>4S12FLE12</b>	-12	19	-12	38,1	1.50	128,6	5.06	92,4	3.64	14,2	0.56	43,2	1.70
<b>4S16FLE12</b>	-16	19	-12	44,4	1.75	147,0	5.79	110,8	4.36	14,2	0.56	51,5	2.03
<b>4S16FLE16</b>	-16	25	-16	44,4	1.75	150,1	5.91	110,3	4.34	19,2	0.76	51,5	2.03
<b>4S20FLE16</b>	-20	25	-16	50,8	2.00	175,4	6.91	135,7	5.34	19,2	0.76	64,4	2.54
<b>4S20FLE20</b>	-20	31	-20	50,8	2.00	191,8	7.55	136,8	5.39	25,2	0.99	64,4	2.54
<b>4S24FLE20</b>	-24	31	-20	60,4	2.38	180,8	7.12	125,8	4.95	25,2	0.99	59,5	2.34
<b>4S24FLE24</b>	-24	38	-24	60,3	2.37	244,2	9.61	166,2	6.54	31,1	1.22	75,2	2.96
<b>4S32FLE24</b>	-32	38	-24	71,4	2.81	294,1	11.58	216,1	8.51	31,1	1.22	99,3	3.91
<b>4S32FLE32</b>	-32	51	-32	71,4	2.81	297,0	11.69	219,0	8.62	42,1	1.66	99,3	3.91

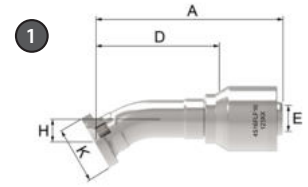

# FLF

SAE Code 61 Flange (30° elbow)

PART 4S part #	HOSE SIZE INFO			DIMENSIONS									
	Terminal End Hose Size	DN	Hose size	Flange Head Dia. K Ø		A		D		EØ		H	
				mm	in	mm	in	mm	in	mm	in	mm	in
<b>4S12FLF12</b>	-12	19	-12	38,1	1.50	119,4	4.70	83,3	3.28	14,2	0.56	16,4	0.65
<b>4S16FLF12</b>	-16	19	-12	44,4	1.75	134,6	5.30	98,4	3.87	14,2	0.56	19,3	0.76
<b>4S16FLF16</b>	-16	25	-16	44,4	1.75	137,7	5.42	97,9	3.85	19,2	0.76	19,3	0.76
<b>4S20FLF16</b>	-20	25	-16	50,8	2.00	158,3	6.23	118,6	4.67	19,2	0.76	23,3	0.92
<b>4S20FLF20</b>	-20	31	-20	50,8	2.00	174,7	6.88	119,7	4.71	25,2	0.99	23,3	0.92
<b>4S24FLF20</b>	-24	31	-20	60,4	2.38	169,9	6.69	114,9	4.52	25,2	0.99	24,1	0.95
<b>4S24FLF24</b>	-24	38	-24	60,3	2.37	223,4	8.80	145,4	5.72	31,1	1.22	26,8	1.06
<b>4S32FLF32</b>	-32	51	-32	71,4	2.81	265,9	10.47	187,8	7.39	42,1	1.66	33,9	1.34

# Weatherhead

Spiral – 4S and 6S series

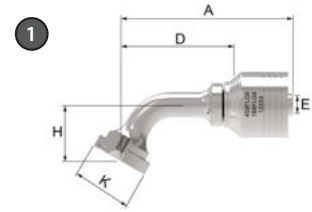

## FLG

SAE Code 61 Flange (60° elbow)

PART 4S part #	HOSE SIZE INFO			DIMENSIONS									
	Terminal End Hose Size	DN	Hose size	Flange Head Dia. K Ø		A		D		EØ		H	
				mm	in	mm	in	mm	in	mm	in	mm	in
<b>4S12FLG12</b>	-12	19	-12	38,1	1.50	133,9	5.27	97,7	3.85	14,2	0.56	37,6	1.48
<b>4S16FLG12</b>	-16	19	-12	44,4	1.75	153,2	6.03	117,1	4.61	14,2	0.56	44,7	1.76
<b>4S16FLG16</b>	-16	25	-16	44,4	1.75	156,4	6.16	116,6	4.59	19,2	0.76	44,7	1.76
<b>4S20FLG16</b>	-20	25	-16	50,8	2.00	183,3	7.22	143,5	5.65	19,2	0.76	55,8	2.20
<b>4S20FLG20</b>	-20	25	-20	50,8	2.00	199,7	7.86	144,7	5.70	25,2	0.99	55,8	2.20
<b>4S24FLG20</b>	-24	31	-20	60,4	2.38	188,1	7.41	133,0	5.24	25,2	0.99	51,7	2.04
<b>4S24FLG24</b>	-24	38	-24	60,3	2.37	253,3	9.97	175,3	6.90	31,1	1.22	65,2	2.57
<b>4S32FLG32</b>	-32	51	-32	71,4	2.81	309,1	12.17	231,1	9.10	42,1	1.66	85,8	3.38



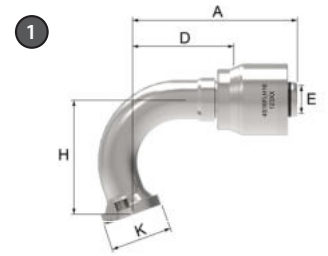

# FLH

SAE Code 61 Flange (110° elbow)

PART	HOSE SIZE INFO			DIMENSIONS									
	Terminal End Hose Size	DN	Hose size	Flange Head Dia. K Ø		A		D		EØ		H	
1 4S part #				mm	in	mm	in	mm	in	mm	in	mm	in
<b>4S16FLH16</b>	-16	25	-16	44,4	1.75	114,6	4.51	74,9	2.95	19,2	0.76	85,2	3.35

# Weatherhead

Spiral – 4S and 6S series

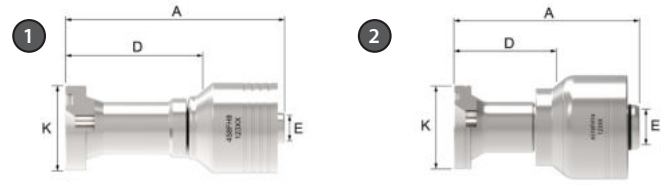

## FH

SAE Code 62 Flange (straight)

PART	HOSE SIZE INFO			DIMENSIONS							
	Terminal End Hose Size	DN	Hose size	Flange Head Dia. K Ø		A		D		EØ	
1 4S part #				mm	in	mm	in	mm	in	mm	in
<b>4S8FH8</b>	-8	12	-8	79,5	3.13	52,3	2.06	9,6	.38	31,8	1.25
<b>4S12FH12</b>	-12	19	-12	41,3	1.63	90,7	3.57	54,5	2.15	14,2	0.56
<b>4S16FH12</b>	-16	19	-12	47,7	1.88	90,2	3.55	54,0	2.13	14,2	0.56
<b>4S12FH16</b>	-12	25	-16	41,3	1.63	96,3	3.79	56,7	2.23	14,2	0.56
<b>4S16FH16</b>	-16	25	-16	47,7	1.88	98,9	3.89	59,1	2.33	19,2	0.76
<b>4S20FH16</b>	-20	25	-16	54,0	2.13	100,8	3.97	61,0	2.40	19,2	0.76
<b>4S16FH20</b>	-16	31	-20	47,7	1.88	123,8	4.87	68,6	2.70	25,2	0.99
<b>4S20FH20</b>	-20	31	-20	54,0	2.13	123,3	4.85	68,1	2.68	25,2	0.99
<b>4S24FH20</b>	-24	31	-20	63,5	2.50	129,0	5.08	73,9	2.91	25,2	0.99
<b>4S24FH24</b>	-24	38	-24	63,5	2.50	189,6	7.46	111,6	4.39	31,1	1.22
<b>4S32FH24</b>	-32	38	-24	79,4	3.13	204,4	8.05	126,4	4.89	31,1	1.22
<b>4S32FH32</b>	-32	51	-32	79,4	3.13	202,7	7.98	124,7	4.91	42,1	1.66
2 6S part #	Terminal End Hose Size	DN	Hose size	Flange Head Dia. K Ø		A		D		EØ	
<b>6S16FH16</b>	-16	25	-16	47,7	1.88	98,8	3.89	59,2	2.33	19,2	0.76
<b>6S20FH16</b>	-20	25	-16	54,0	2.13	100,8	3.97	61,0	2.40	19,2	0.76
<b>6S20FH20</b>	-20	31	-20	54,0	2.13	124,0	4.88	68,1	2.68	25,2	0.99
<b>6S24FH20</b>	-24	31	-20	63,5	2.50	129,8	5.11	73,9	2.91	25,2	0.99
<b>6S24FH24</b>	-24	38	-24	63,5	2.50	189,6	7.46	111,6	4.39	31,1	1.22
<b>6S32FH24</b>	-32	38	-24	79,4	3.13	204,4	8.05	126,4	4.98	31,1	1.22
<b>6S32FH32</b>	-32	51	-32	79,4	3.13	202,7	7.98	124,7	4.91	42,1	1.66

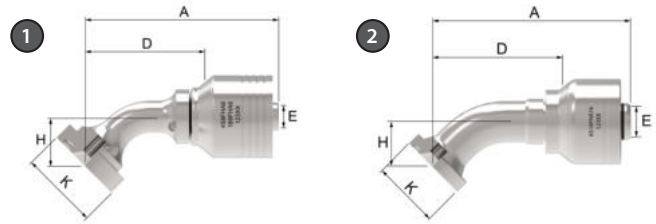

# FHA

SAE Code 62 Flange (45° elbow)

PART	HOSE SIZE INFO			DIMENSIONS									
	Terminal End Hose Size	DN	Hose size	Flange Head Dia. K Ø		A		D		EØ		H	
1 4S part #				mm	in	mm	in	mm	in	mm	in	mm	in
4S12FHA12	-12	19	-12	41,3	1.63	113,8	4.48	77,6	3.06	14,2	0.56	27,0	1.06
4S16FHA12	-16	19	-12	47,7	1.88	128,0	5.04	91,7	3.61	14,2	0.56	32,0	1.26
4S12FHA16	-12	25	-16	41,3	1.63	116,9	4.60	77,2	3.04	15,1	0.59	27,0	1.06
4S16FHA16	-16	25	-16	47,7	1.88	130,9	5.15	91,2	3.59	19,2	0.76	32,0	1.26
4S20FHA16	-20	25	-16	54,0	2.13	150,2	5.91	110,5	4.35	19,2	0.76	39,0	1.54
4S20FHA20	-20	31	-20	54,0	2.13	166,6	6.56	111,6	4.39	25,2	0.99	39,0	1.54
4S24FHA20	-24	31	-20	63,5	2.50	183,2	7.21	128,2	5.05	25,2	0.99	45,0	1.77
4S24FHA24	-24	38	-24	63,5	2.50	214,1	8.43	136,1	5.36	31,1	1.22	45,0	1.77
4S32FHA24	-32	38	-24	79,4	3.13	251,0	9.88	173,0	6.81	31,1	1.22	57,5	2.26
4S32FHA32	-32	51	-32	79,4	3.13	253,9	10.00	175,9	6.93	42,1	1.66	57,5	2.26
2 6S part #	Terminal End Hose Size	DN	Hose size	Flange Head Dia. K Ø		A		D		EØ		H	
6S16FHA16	-16	25	-16	47,7	1.88	130,9	5.15	91,2	3.59	19,2	0.76	32,0	1.26
6S20FHA16	-20	25	-16	54,0	2.13	150,2	5.91	110,0	4.35	19,0	0.75	39,0	1.54
6S20FHA20	-20	31	-20	54,0	2.13	167,6	6.60	111,6	4.39	25,2	0.99	39,0	1.54
6S24FHA20	-24	31	-20	63,5	2.50	184,2	7.25	128,2	5.05	25,2	0.99	45,0	1.77
6S24FHA24	-24	38	-24	63,5	2.50	214,1	8.43	136,1	5.36	31,1	1.22	45,0	1.77
6S32FHA24	-32	38	-24	79,4	3.13	251,0	9.88	173,0	6.81	31,1	1.22	57,5	2.26
6S32FHA32	-32	51	-32	79,4	3.13	253,9	10.00	175,9	6.93	42,1	1.66	57,5	2.26

# Weatherhead

Spiral – 4S and 6S series

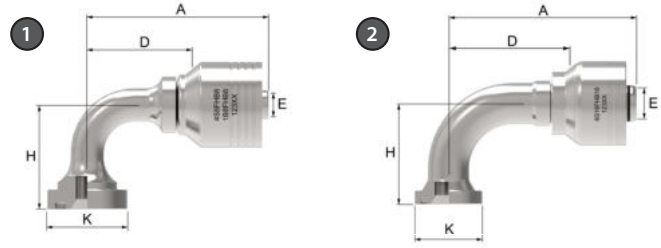

## FHB

SAE Code 62 Flange (90° elbow)

PART	HOSE SIZE INFO					DIMENSIONS							
	Terminal End Hose Size	DN	Hose size	Flange Head Dia KØ		A		D		EØ		H	
<b>1</b> 4S part #				mm	in	mm	in	mm	in	mm	in	mm	in
<b>4S8FHB8</b>	-8	12	-8	69,5	2,74	42,3	1,67	9,1	.36	41,4	1,63	31,8	1,25
<b>4S12FHB12</b>	-12	19	-12	41,3	1,63	108,5	4,27	72,3	2,85	14,2	0,56	59,0	2,32
<b>4S16FHB12</b>	-16	19	-12	47,7	1,88	122,9	4,84	86,6	3,41	14,2	0,56	71,0	2,80
<b>4S16FHB16</b>	-16	25	-16	47,7	1,88	125,5	4,94	86,1	3,39	19,2	0,76	71,0	2,80
<b>4S16FHB16.120</b>	-16	25	-16	47,7	1,88	126,0	4,96	86,2	3,39	19,2	0,76	120,0	4,72
<b>4S20FHB16</b>	-20	25	-16	54,0	2,13	145,3	5,72	105,4	4,15	19,2	0,76	89,0	3,50
<b>4S16FHB20</b>	-16	31	-20	47,7	1,88	147,1	5,79	91,9	3,62	25,2	0,99	71,0	2,80
<b>4S20FHB20</b>	-20	31	-20	54,0	2,13	161,5	6,36	106,5	4,19	25,2	0,99	89,0	3,50
<b>4S20FHB20.120</b>	-20	31	-20	54,0	2,13	161,5	6,36	106,5	4,19	25,2	0,99	120,0	4,72
<b>4S24FHB20</b>	-24	31	-20	63,5	2,50	178,0	7,01	123,0	4,84	25,2	0,99	104,0	4,09
<b>4S24FHB24</b>	-24	38	-24	63,5	2,50	208,9	8,22	130,8	5,15	31,1	1,22	104,0	4,09
<b>4S32FHB24</b>	-32	38	-24	79,4	3,13	247,4	9,74	169,4	6,67	31,1	1,22	138,0	5,43
<b>4S32FHB32</b>	-32	51	-32	79,4	3,13	250,3	9,85	172,2	6,78	42,1	1,66	138,0	5,43
<b>2</b> 6S part #													
<b>6S16FHB16</b>	-16	25	-16	47,7	1,88	125,5	4,94	86,1	3,39	19,2	0,76	71,0	2,80
<b>6S20FHB16</b>	-20	25	-16	54,0	2,13	145,3	5,72	105,4	4,15	19,2	0,76	89,0	3,50
<b>6S16FHB20</b>	-16	31	-20	47,7	1,88	147,9	5,82	91,9	3,62	25,2	0,99	71,0	2,80
<b>6S20FHB20</b>	-20	31	-20	54,0	2,13	162,5	6,40	106,5	4,19	25,2	0,99	89,0	3,50
<b>6S24FHB20</b>	-24	31	-20	63,5	2,50	179,0	7,05	123,0	4,84	25,2	0,99	104,0	4,09
<b>6S24FHB24</b>	-24	38	-24	63,5	2,50	208,9	8,22	130,8	5,15	31,1	1,22	104,0	4,09
<b>6S32FHB24</b>	-32	38	-24	79,4	3,13	247,4	9,74	169,4	6,67	31,1	1,22	138,0	5,43
<b>6S32FHB32</b>	-32	51	-32	79,4	3,13	250,3	9,85	172,2	6,78	42,1	1,66	138,0	5,43

Spiral – 4S and 6S series

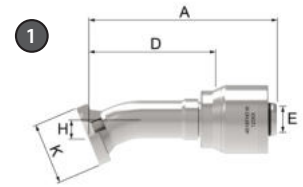

# FHD

SAE Code 62 Flange (22.5° elbow)

PART 4S part #	HOSE SIZE INFO			DIMENSIONS									
	Terminal End Hose Size	DN	Hose size	Flange Head Dia. K Ø		A		D		EØ		H	
				mm	in	mm	in	mm	in	mm	in	mm	in
<b>4S16FHD16</b>	-16	25	-16	47,7	1.88	140,0	5.51	100,1	3.94	19,2	0.76	13,5	0.53
<b>4S20FHD16</b>	-20	25	-16	54,0	2.13	160,9	6.33	121,2	4.77	19,2	0.76	16,3	0.64
<b>4S32FHD32</b>	-32	51	-32	79,4	3.13	269,6	10.61	191,5	7.54	42,1	1.66	23,5	0.93

## Weatherhead

Spiral – 4S and 6S series

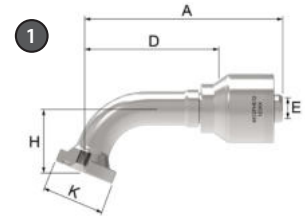

## FHE

SAE Code 62 Flange (67.5° elbow)

PART 4S part #	HOSE SIZE INFO			DIMENSIONS									
	Terminal End Hose Size	DN	Hose size	Flange Head Dia. K Ø		A		D		EØ		H	
				mm	in	mm	in	mm	in	mm	in	mm	in
<b>4532FHE32</b>	-32	51	-32	79,4	3.13	297,0	11.69	219,0	8.62	42,1	1.66	99,3	3.91

Spiral – 4S and 6S series

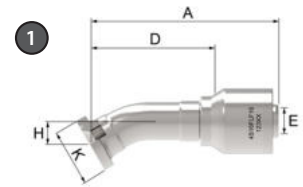

# FHF

SAE Code 62 Flange (30° elbow)

PART 4S part #	HOSE SIZE INFO			DIMENSIONS									
	Terminal End Hose Size	DN	Hose size	Flange Head Dia. K Ø		A		D		EØ		H	
				mm	in	mm	in	mm	in	mm	in	mm	in
<b>4S24FHF20</b>	-20	31	-20	63,5	2.50	192,6	7.58	137,6	5.42	25.2	0.99	26,8	1.06
<b>4S32FHF32</b>	-32	51	-32	79,4	3.13	265,8	10.47	187,8	7.39	42,1	1.66	33,9	1.34

# Weatherhead

Spiral – 4S and 6S series

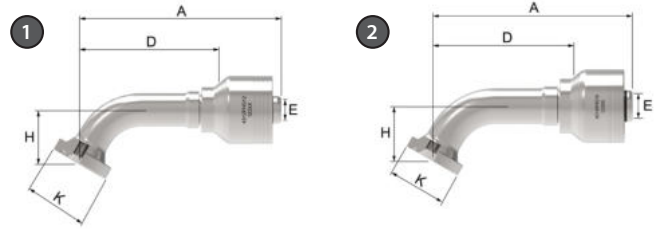

## FHG

SAE Code 62 Flange (60° elbow)

PART		HOSE SIZE INFO			DIMENSIONS									
1	4S part #	Terminal End Hose Size	DN	Hose size	Flange Head Dia. K Ø		A		D		EØ		H	
					mm	in	mm	in	mm	in	mm	in	mm	in
	<b>4S12FHG12</b>	-12	19	-12	41,3	1.63	133,9	5.27	97,7	3.85	14,2	0.56	37,6	1.48
	<b>4S16FHG16</b>	-16	25	-16	47,7	1.88	156,4	6.16	116,6	4.59	19,2	0.76	44,6	1.76
	<b>4S32FHG32</b>	-32	51	-32	79,4	3.13	309,1	12.17	231,1	9.10	42,1	1.66	85,8	3.38
2	6S part #	Terminal End Hose Size	DN	Hose size	Flange Head Dia. K Ø		A		D		EØ		H	
					mm	in	mm	in	mm	in	mm	in	mm	in
	<b>6S16FHG16</b>	-16	25	-16	47,7	1.88	156,4	6.16	116,6	4.59	19,2	0.76	44,7	1.76
	<b>6S20FHG16</b>	-20	25	-16	54,0	2.13	183,3	7.22	143,5	5.65	19,2	0.76	55,8	2.20
	<b>6S20FHG20</b>	-20	31	-20	54,0	2.13	200,6	7.90	144,6	5.69	25,2	0.99	55,8	2.20



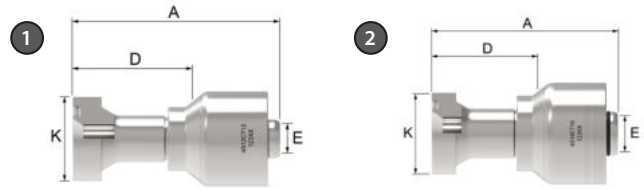

# CT

CAT Flange (straight)

PART	HOSE SIZE INFO			DIMENSIONS							
	Terminal End Hose Size	DN	Hose size	Flange Head Dia. K Ø		A		D		E Ø	
1 4S part #				mm	in	mm	in	mm	in	mm	in
<b>4S12CT12</b>	-12	19	-12	41,3	1.63	96,2	3.79	60,0	2.36	14,2	0.56
<b>4S16CT12</b>	-16	19	-12	47,6	1.87	94,9	3.74	58,7	2.31	14,2	0.56
<b>4S16CT16</b>	-16	25	-16	47,6	1.87	102,1	4.02	62,3	2.45	19,2	0.76
<b>4S20CT16</b>	-20	25	-16	54,0	2.13	104,8	4.13	65,0	2.56	19,2	0.76
<b>4S20CT20</b>	-20	31	-20	54,0	2.13	124,5	4.90	69,1	2.72	25,2	0.99
<b>4S24CT20</b>	-24	31	-20	63,5	2.50	130,9	5.15	75,9	2.99	25,2	0.99
<b>4S24CT24</b>	-24	38	-24	63,5	2.50	195,0	7.68	117,0	4.61	31,1	1.22
<b>4S32CT24</b>	-32	38	-24	79,4	3.13	206,0	8.11	128,0	5.04	31,1	1.22
<b>4S32CT32</b>	-32	51	-32	79,4	3.13	208,9	8.22	130,9	5.15	42,1	1.66
2 6S part #	Terminal End Hose Size	DN	Hose size	Flange Head Dia. K Ø		A		D		E Ø	
<b>6S16CT16</b>	-16	25	-16	47,6	1.87	102,1	4.02	62,3	2.45	19,2	0.76
<b>6S20CT16</b>	-20	25	-16	54,0	2.13	104,8	4.13	65,0	2.56	19,2	0.76
<b>6S20CT20</b>	-20	31	-20	54,0	2.13	125,2	4.93	69,1	2.72	25,2	0.99
<b>6S24CT20</b>	-24	31	-20	63,5	2.50	131,8	5.19	75,9	2.99	25,2	0.99
<b>6S24CT24</b>	-24	38	-24	63,5	2.50	195,0	7.68	117,0	4.61	31,1	1.22
<b>6S32CT24</b>	-32	38	-24	79,4	3.13	206,0	8.11	128,1	5.04	31,1	1.22
<b>6S32CT32</b>	-32	51	-32	79,4	3.13	208,9	8.22	130,9	5.15	42,1	1.66

# Weatherhead

Spiral – 4S and 6S series

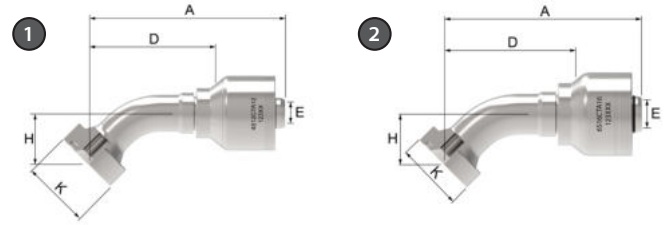

## CTA

CAT Flange (45° elbow)

PART	HOSE SIZE INFO					DIMENSIONS							
	Terminal End Hose Size	DN	Hose size	Flange Head Dia KØ		A		D		EØ		H	
<b>1</b> 4S part #				mm	in	mm	in	mm	in	mm	in	mm	in
<b>4S12CTA12</b>	-12	19	-12	41,3	1,63	117,7	4.63	81,5	3.21	14,2	0.56	30,9	1.22
<b>4S16CTA12</b>	-16	19	-12	47,6	1,87	131,2	5.17	95,0	3.74	14,2	0.56	35,3	1.39
<b>4S16CTA16</b>	-16	25	-16	47,6	1,87	134,3	5.29	94,6	3.72	19,2	0.76	35,3	1.39
<b>4S20CTA16</b>	-20	25	-16	54,0	2,13	153,0	6.02	113,2	4.46	19,2	0.76	41,8	1.65
<b>4S20CTA20</b>	-20	31	-20	54,0	2,13	169,4	6.67	114,3	4.50	25,2	0.99	41,8	1.65
<b>4S24CTA20</b>	-24	31	-20	63,5	2.50	185,3	7.30	129,1	5.08	25,2	0.99	46,2	1.82
<b>4S24CTA24</b>	-24	38	-24	63,5	2.50	215,2	8.47	137,2	5.40	31,1	1.22	46,2	1.82
<b>4S32CTA32</b>	-32	51	-32	79,4	3.13	255,1	10.04	177,0	6.97	42,1	1.66	58,7	1.31
<b>2</b> 6S part #													
<b>6S16CTA16</b>	-16	25	-16	47,6	1,87	134,3	5.29	94,6	3.72	19,2	0.76	35,3	1.39
<b>6S20CTA16</b>	-20	25	-16	54,0	2,13	153,0	6.02	113,2	4.46	19,2	0.76	41,8	1.65
<b>6S20CTA20</b>	-20	31	-20	54,0	2,13	170,3	6.70	114,3	4.50	25,2	0.99	41,8	1.65
<b>6S24CTA20</b>	-24	31	-20	63,5	2.50	185,3	7.30	129,1	5.08	25,2	0.99	46,2	1.82
<b>6S24CTA24</b>	-24	38	-24	63,5	2.50	215,2	8.47	137,2	5.40	31,1	1.22	46,2	1.82
<b>6S32CTA24</b>	-32	38	-24	79,4	3.13	252,2	9.93	174,2	6.86	31,1	1.22	58,7	2.31
<b>6S32CTA32</b>	-32	51	-32	79,4	3.13	255,1	10.04	177,0	6.97	42,1	1.66	58,7	2.31

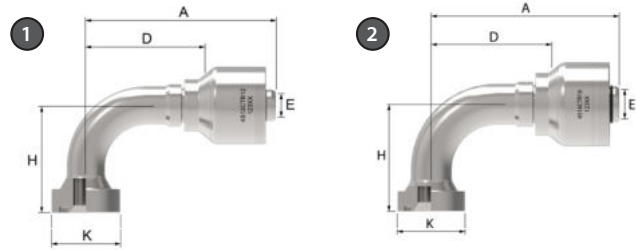

# CTB

CAT Flange (90° elbow)

PART		HOSE SIZE INFO				DIMENSIONS							
1 4S part #	Terminal End Hose Size	DN	Hose size	Flange Head Dia KØ		A		D		EØ		H	
				mm	in	mm	in	mm	in	mm	in	mm	in
<b>4S12CTB12</b>	-12	19	-12	41,3	1.63	108,5	4.27	72,3	2.85	14,2	0.56	64,5	2.54
<b>4S16CTB12</b>	-16	19	-12	47,6	1.87	122,8	4.83	86,6	3.41	14,2	0.56	75,7	2.98
<b>4S16CTB16</b>	-16	25	-16	47,6	1.87	126,0	4.96	86,2	3.39	19,2	0.76	75,7	2.98
<b>4S20CTB16</b>	-20	25	-16	54,0	2.13	145,2	5.72	105,4	4.15	19,2	0.76	92,9	3.66
<b>4S20CTB20</b>	-20	31	-20	54,0	2.13	161,5	6.36	106,5	4.19	25,2	0.99	92,9	3.66
<b>4S24CTB20</b>	-24	31	-20	63,5	2.50	179,0	7.05	123,0	4.84	25,2	0.99	105,6	4.16
<b>4S24CTB24</b>	-24	38	-24	63,5	2.50	208,9	8.22	130,9	5.15	31,1	1.22	105,7	4.16
<b>4S32CTB32</b>	-32	51	-32	79,4	3.13	250,3	9.85	172,2	6.78	42,1	1.66	139,7	5.50
2 6S part #	Terminal End Hose Size	DN	Hose size	Flange Head Dia KØ		A		D		EØ		H	
				mm	in	mm	in	mm	in	mm	in	mm	in
<b>6S16CTB16</b>	-16	25	-16	47,6	1.87	126,0	4.96	86,2	3.39	19,2	0.76	75,7	2.98
<b>6S20CTB16</b>	-20	25	-16	54,0	2.13	145,2	5.72	105,4	4.15	19,2	0.76	92,9	3.66
<b>6S20CTB20</b>	-20	31	-20	54,0	2.13	162,5	6.40	106,5	4.19	25,2	0.99	92,9	3.66
<b>6S24CTB20</b>	-24	31	-20	63,5	2.50	179,0	7.05	123,0	4.84	25,2	0.99	105,6	4.16
<b>6S24CTB24</b>	-24	38	-24	63,5	2.50	208,9	8.22	130,9	5.15	31,1	1.22	105,7	4.16
<b>6S32CTB24</b>	-32	38	-24	69,6	2.74	247,4	9.74	169,4	6.67	31,1	1.22	139,7	5.50
<b>6S32CTB32</b>	-32	51	-32	79,4	3.13	250,3	9.85	172,2	6.78	42,1	1.66	139,7	5.50

# Weatherhead

Spiral – 4S and 6S series

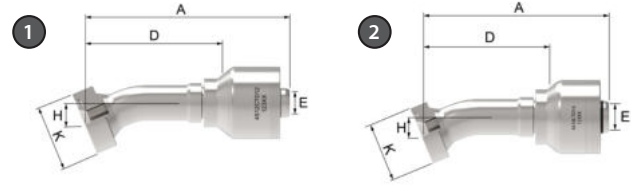

## CTD

CAT Flange (22.5° elbow)

PART	HOSE SIZE INFO					DIMENSIONS							
1 4S part #	Terminal End Hose Size	DN	Hose size	Flange Head Dia KØ		A		D		EØ		H	
				mm	in	mm	in	mm	in	mm	in	mm	in
<b>4S12CTD12</b>	-12	19	-12	41,3	1.63	126,2	4.97	90,2	3.55	14,2	0.56	13,6	0.54
<b>4S16CTD16</b>	-16	25	-16	47,6	1.87	144,2	5.68	104,4	4.11	19,2	0.76	15,3	0.60
<b>4S20CTD16</b>	-20	25	-16	54,0	2.13	164,5	6.48	124,8	4.91	19,2	0.76	17,8	0.70
<b>4S20CTD20</b>	-20	31	-20	54,0	2.13	181,9	7.16	125,9	4.96	25,2	0.99	17,8	0.70
<b>4S24CTD20</b>	-24	31	-20	63,5	2.50	198,0	7.80	142,0	5.59	25,2	0.99	19,4	0.76
<b>4S24CTD24</b>	-24	38	-24	63,5	2.50	227,9	8.97	149,9	5.90	31,1	1.22	19,4	0.76
<b>4S32CTD32</b>	-32	51	-32	79,4	3.13	271,1	10.67	193,0	7.60	42,1	1.66	24,2	0.95
2 6S part #	Terminal End Hose Size	DN	Hose size	Flange Head Dia KØ		A		D		EØ		H	
				mm	in	mm	in	mm	in	mm	in	mm	in
<b>6S16CTD16</b>	-16	25	-16	47,6	1.87	144,2	5.68	104,4	4.11	19,2	0.76	15,3	0.60
<b>6S20CTD16</b>	-20	25	-16	54,0	2.13	164,5	6.48	124,8	4.91	19,2	0.76	17,8	0.70
<b>6S20CTD20</b>	-20	31	-20	54,0	2.13	181,9	7.16	125,9	4.96	25,2	0.99	17,8	0.70
<b>6S24CTD20</b>	-24	31	-20	63,5	2.50	198,0	7.80	142,0	5.59	25,2	0.99	19,4	0.76
<b>6S24CTD24</b>	-24	38	-24	63,5	2.50	227,9	8.97	149,9	5.90	31,1	1.22	19,4	0.76
<b>6S32CTD32</b>	-32	51	-32	79,4	3.13	271,1	10.67	193,0	7.60	42,1	1.66	24,2	0.95

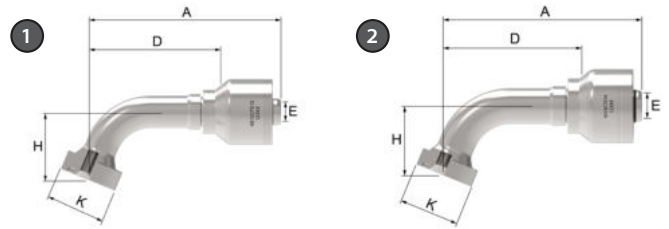

## CTE

CAT Flange (67.5° elbow)

PART	HOSE SIZE INFO					DIMENSIONS							
	Terminal End Hose Size	DN	Hose size	Flange Head Dia KØ		A		D		EØ		H	
1 4S part #				mm	in	mm	in	mm	in	mm	in	mm	in
<b>4S12CTE12</b>	-12	19	-12	41,3	1.63	130,7	5.15	94,5	3.72	14,2	0.56	48,3	1.90
<b>4S16CTE16</b>	-16	25	-16	47,6	1.87	151,9	5.98	112,2	4.42	19,2	0.76	55,8	2.20
<b>4S20CTE16</b>	20	25	-16	54,0	2.13	176,9	6.96	137,1	5.40	19,2	0.76	68,1	2.68
<b>4S20CTE20</b>	-20	31	-20	54,0	2.13	194,2	7.65	138,3	5.44	25,2	0.99	68,1	2.68
<b>4S24CTE20</b>	-24	31	-20	63,5	2.50	214,9	8.46	159,0	6.26	25,2	0.99	76,8	3.02
<b>4S24CTE24</b>	-24	38	-24	63,5	2.50	244,8	9.64	166,8	6.57	31,1	1.22	76,8	3.02
<b>4S32CTE32</b>	-32	51	-32	79,4	3.13	297,6	11.72	219,6	8.65	42,1	1.66	100,8	3.97
2 6S part #	Terminal End Hose Size	DN	Hose size	Flange Head Dia KØ		A		D		EØ		H	
<b>6S16CTE16</b>	-16	25	-16	47,6	1.87	151,9	5.98	112,2	4.42	19,2	0.76	55,8	2.20
<b>6S20CTE16</b>	-20	25	-16	54,0	2.13	176,9	6.96	137,1	5.40	19,2	0.76	68,1	2.68
<b>6S20CTE20</b>	-20	31	-20	54,0	2.13	194,2	7.65	138,3	5.44	25,2	0.99	68,1	2.68
<b>6S24CTE20</b>	-24	31	-20	63,5	2.50	214,9	8.46	159,0	6.26	25,2	0.99	76,8	3.02
<b>6S24CTE24</b>	-24	38	-24	63,5	2.50	244,8	9.64	166,8	6.57	31,1	1.22	76,8	3.02
<b>6S32CTE24</b>	-32	38	-24	79,4	3.13	294,7	11.60	216,7	8.53	31,1	1.22	100,8	3.97
<b>6S32CTE32</b>	-32	51	-32	79,4	3.13	297,6	11.72	219,6	8.65	42,1	1.66	100,8	3.97

# Weatherhead

Spiral – 4S and 6S series

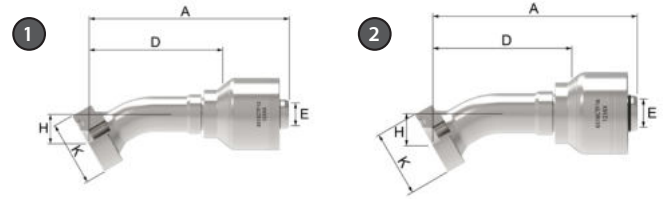

## CTF

CAT Flange (30° elbow)

PART	HOSE SIZE INFO			DIMENSIONS									
	Terminal End Hose Size	DN	Hose size	Flange Head Dia. K Ø		A		D		EØ		H	
1 4S part #				mm	in	mm	in	mm	in	mm	in	mm	in
<b>4S12CTF12</b>	-12	19	-12	41,3	1.63	124,2	4.89	88,0	3.46	14,2	0.56	19,1	0.75
<b>4S16CTF16</b>	-16	25	-16	47,6	1.87	141,7	5.58	102,0	4.02	19,2	0.76	21,6	0.85
<b>4S20CTF16</b>	-20	25	-16	54,0	2.13	161,7	6.37	122,0	4.80	19,2	0.76	25,3	1.00
<b>4S20CTF20</b>	-20	31	-20	54,0	2.13	179,1	7.05	123,1	4.85	25,2	0.99	25,3	1.00
<b>4S24CTF20</b>	-24	31	-20	63,5	2.50	194,9	7.67	138,9	5.47	25,2	0.99	27,7	1.09
<b>4S24CTF24</b>	-24	38	-24	63,5	2.50	224,8	8.85	146,8	5.78	31,1	1.22	27,7	1.09
<b>4S32CTF32</b>	-32	51	-32	79,4	3.13	267,3	10.52	189,2	7.45	42,1	1.66	34,8	1.37
2 6S part #	Terminal End Hose Size	DN	Hose size	Flange Head Dia. K Ø		A		D		EØ		H	
<b>6S16CTF16</b>	-16	25	-16	47,6	1.87	141,7	5.58	102,0	4.02	19,2	0.76	21,6	0.85
<b>6S20CTF16</b>	-20	25	-16	54,0	2.13	161,7	6.37	122,0	4.80	19,2	0.76	25,3	1.00
<b>6S20CTF20</b>	-20	31	-20	54,0	2.13	179,1	7.05	123,1	4.85	25,2	0.99	25,3	1.00
<b>6S24CTF20</b>	-24	31	-20	63,5	2.50	194,9	7.67	138,9	5.47	25,2	0.99	27,7	1.09
<b>6S24CTF24</b>	-24	38	-24	63,5	2.50	224,8	8.85	146,8	5.78	31,1	1.22	27,7	1.09
<b>6S32CTF24</b>	-32	38	-24	79,4	3.13	264,3	10.41	186,3	7.34	31,1	1.22	34,8	1.37
<b>6S32CTF32</b>	-32	51	-32	79,4	3.13	267,3	10.52	189,2	7.45	42,1	1.66	34,8	1.37

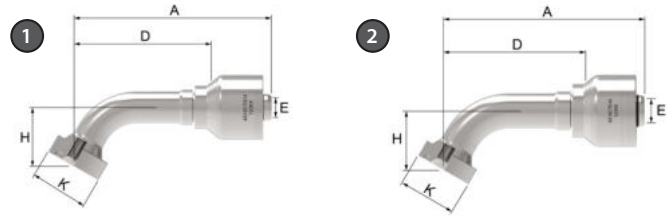

# CTG

CAT Flange (60° elbow)

PART		HOSE SIZE INFO			DIMENSIONS								
1 4S part #	Terminal End Hose Size	DN	Hose size	Flange Head Dia. K Ø		A		D		EØ		H	
				mm	in	mm	in	mm	in	mm	in	mm	in
<b>4S12CTG12</b>	-12	19	-12	41,3	1.63	136,6	5.38	100,5	3.96	14,2	0.56	42,3	1.67
<b>4S16CTG16</b>	-16	25	-16	47,6	1.87	158,8	6.25	119,0	4.69	19,2	0.76	48,7	1.92
<b>4S20CTG16</b>	-20	25	-16	54,0	2.13	185,2	7.29	145,5	5.73	19,2	0.76	59,2	2.33
<b>4S20CTG20</b>	-20	31	-20	54,0	2.13	202,6	7.98	146,6	5.77	25,2	0.99	59,2	2.33
<b>4S24CTG20</b>	-24	31	-20	63,5	2.50	224,3	8.83	168,3	6.63	25,2	0.99	66,6	2.62
<b>4S24CTG24</b>	-24	38	-24	63,5	2.50	254,2	10.01	176,2	6.94	31,1	1.22	66,6	2.62
<b>4S32CTG32</b>	-32	51	-32	79,4	3.13	310,0	12.20	231,9	9.13	42,1	1.66	87,3	3.44
2 6S part #	Terminal End Hose Size	DN	Hose size	Flange Head Dia. K Ø		A		D		EØ		H	
				mm	in	mm	in	mm	in	mm	in	mm	in
<b>6S16CTG16</b>	-16	19	-12	41,3	1.63	130,7	5.15	95,5	3.72	14,2	0.56	48,3	1.90
<b>6S20CTG16</b>	-20	25	-16	54,0	2.13	185,2	7.29	145,5	5.73	19,2	0.76	59,2	2.33
<b>6S20CTG20</b>	-20	31	-20	54,0	2.13	202,6	7.98	146,6	5.77	25,2	0.99	59,2	2.33
<b>6S24CTG20</b>	-24	31	-20	63,5	2.50	224,3	8.83	168,3	6.63	25,2	0.99	66,6	2.62
<b>6S24CTG24</b>	-24	38	-24	63,5	2.50	254,2	10.01	176,2	6.94	31,1	1.22	66,6	2.62
<b>6S32CTG24</b>	-32	38	-24	79,4	3.13	307,0	12.09	229,0	9.02	31,1	1.22	87,3	3.44
<b>6S32CTG32</b>	-32	51	-32	79,4	3.13	310,0	12.20	231,9	9.13	42,1	1.66	87,3	3.44

## Weatherhead

Spiral – 4S and 6S series

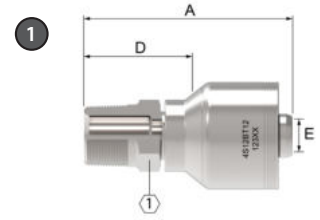

## BT

BSP Male tapered rigid (straight)

PART 4S part #	HOSE SIZE INFO			DIMENSIONS							
	Terminal End Hose Size	DN	Hose size	Thread	A		D		EØ		①
					mm	in	mm	in	mm	in	mm
<b>4S12BT12</b>	-12	19	-12	R 3/4	84,0	3.31	47,7	1.88	14,2	0.56	27,0
<b>4S16BT16</b>	-16	25	-16	R 1	94,9	3.74	55,2	2.17	19,2	0.75	36,0
<b>4S20BT20</b>	-20	31	-20	R 1 1/4	118,4	4.66	63,3	2.49	25,2	0.99	46,0

"R" as part of thread size is ISO designation for tapered thread.



Spiral – 4S and 6S series

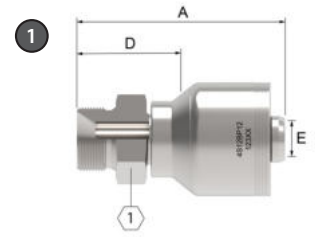

## BP

Male parallel rigid (60° cone seat straight)

PART	HOSE SIZE INFO			DIMENSIONS								
	Terminal End Hose Size	DN	Hose size	Thread	A		D		EØ		⊘	
1 4S part #					mm	in	mm	in	mm	in	mm	in
<b>4S12BP12</b>	-12	19	-12	G 3/4	79,6	3.13	43,4	1.71	14,2	0.56	32,0	27,0
<b>4S16BP16</b>	-16	25	-16	G 1	89,8	3.53	50,1	1.97	19,2	0.75	41,0	36,0
<b>4S20BP20</b>	-20	31	-20	G 1 1/4	109,7	4.32	54,5	2.15	25,1	0.99	50,0	46,0

\*G\* as part of thread size is ISO designation for parallel thread.

# Weatherhead

Spiral – 4S and 6S series

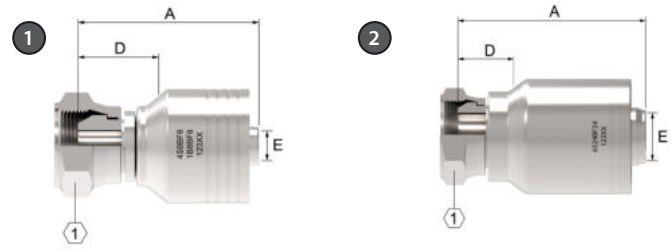

## BF

Female BSPP swivel (60° cone street straight)

PART	HOSE SIZE INFO			DIMENSIONS							
	Terminal End Hose Size	DN	Hose size	Thread	A		D		EØ		1
4S part #					mm	in	mm	in	mm	in	mm
<b>4S6BF6</b>	-6	10	-6	G 3/8	46,4	1.83	21,1	.83	6,7	.26	22
<b>4S8BF8</b>	-8	12	-8	G 1/2	53,5	2.11	23,8	.94	9,6	.38	27
<b>4S12BF12</b>	-12	19	-12	G 3/4	66,2	2.61	29,9	1.18	14,2	0.56	32,0
<b>4S16BF12</b>	-16	19	-12	G 1	68,7	2.70	32,3	1.27	14,2	0.56	41,0
<b>4S16BF16</b>	-16	25	-16	G 1	71,0	2.80	32,3	1.27	19,2	0.76	41,0
<b>4S20BF16</b>	-20	25	-16	G 1 1/4	72,5	2.85	32,7	1.29	19,2	0.76	50,0
<b>4S20BF20</b>	-20	31	-20	G 1 1/4	82,8	3.26	32,7	1.29	25,2	0.99	50,0
<b>4S24BF24</b>	-24	38	-24	G 1 1/2	117,9	4.64	39,8	1.57	31,1	1.22	55,0
<b>4S32BF32</b>	-32	51	-32	G 2	121,0	4.76	43,0	1.69	42,1	1.66	70,0
6S part #	Terminal End Hose Size	DN	Hose size	Thread	A		D		EØ		1
<b>6S24BF24</b>	-24	38	-24	G 1 1/2	117,9	4.64	39,8	1.57	31,1	1.22	55,0
<b>6S32BF32</b>	-32	51	-32	G 2	121,0	4.76	43,0	1.69	42,1	1.66	70,0

"G" as part of thread size is ISO designation for parallel thread.

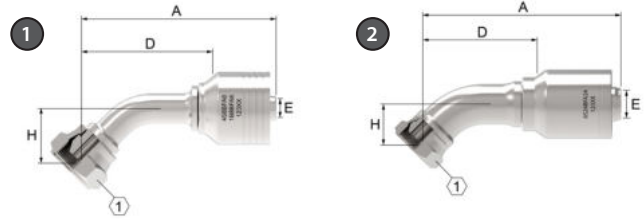

# BFA

Female BSPP swivel (60° cone seat 45° elbow)

PART	HOSE SIZE INFO			DIMENSIONS									
	Terminal End Hose Size	DN	Hose size	Thread	A		D		EØ		H		1
4S part #					mm	in	mm	in	mm	in	mm	in	mm
<b>4S8BFA8</b>	-8	12	-8	G 1/2	91,5	3,6	61,8	2,43	9,6	.38	24,8	.98	27
<b>4S12BFA12</b>	-12	19	-12	G 3/4	112,3	4,42	75,9	2,99	14,2	0,56	26,0	1,02	32,0
<b>4S16BFA12</b>	-16	19	-12	G 1	115,8	4,56	79,5	3,13	14,2	0,56	30,0	1,18	41,0
<b>4S16BFA16</b>	-16	25	-16	G 1	130,3	5,13	90,6	3,57	19,2	0,76	30,0	1,18	41,0
<b>4S20BFA16</b>	-20	25	-16	G 1 1/4	133,0	5,24	93,4	3,68	19,2	0,76	34,0	1,34	50,0
<b>4S20BFA20</b>	-20	31	-20	G 1 1/4	149,5	5,89	99,1	3,90	25,2	0,99	34,0	1,34	50,0
<b>4S24BFA24</b>	-24	38	-24	G 1 1/2	208,3	8,20	130,3	5,13	31,1	1,22	42,4	1,67	55,0
<b>4S32BFA32</b>	-32	51	-32	G 2	248,4	9,78	170,4	6,71	42,1	1,66	54,1	2,13	70,0
6S part #	Terminal End Hose Size	DN	Hose size	Thread	A		D		EØ		H		1
<b>6S24BFA24</b>	-24	38	-24	G 1 1/2	208,3	8,20	130,3	5,13	31,1	1,22	42,4	1,67	55,0
<b>6S32BFA32</b>	-32	51	-32	G 2	248,4	9,78	170,4	6,71	42,1	1,66	54,1	2,13	70,0

"G" as part of thread size is ISO designation for parallel thread.

# Weatherhead

Spiral – 4S and 6S series

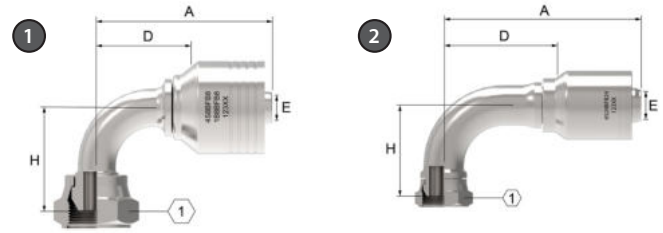

## BFB

Female BSPP swivel (60° cone seat 90° elbow)

PART	HOSE SIZE INFO			DIMENSIONS									
	Terminal End Hose Size	DN	Hose size	Thread	A		D		EØ		H		①
① 4S part #					mm	mm	in	mm	in	mm	in	mm	in
<b>4S6BFB6</b>	-6	10	-6	G 3/8	58,9	2,32	33,6	1,32	6,7	.26	35	1,38	22
<b>4S8BFB8</b>	-8	12	-8	G 1/2	63,9	2,52	34,2	1,35	9,6	.38	37,5	1,48	27
<b>4S12BFB12</b>	-12	19	-12	G 3/4	105,9	4,17	69,6	2,74	14,2	0,56	57,0	2,24	32,0
<b>4S16BFB12</b>	-16	19	-12	G 1	105,9	4,17	69,6	2,74	14,2	0,56	68,0	2,68	41,0
<b>4S16BFB16</b>	-16	25	-16	G 1	125,5	4,94	85,8	3,38	19,2	0,76	68,0	2,68	41,0
<b>4S20BFB16</b>	-20	25	-16	G 1 1/4	125,5	4,94	85,8	3,38	19,2	0,76	79,0	3,11	50,0
<b>4S20BFB20</b>	-20	31	-20	G 1 1/4	145,0	5,71	95,0	3,74	25,2	0,99	79,0	3,11	50,0
<b>4S24BFB24</b>	-24	38	-24	G 1 1/2	205,1	8,07	127,0	5,00	31,1	1,22	98,6	3,88	55,0
<b>4S32BFB32</b>	-32	51	-32	G 2	245,7	9,67	167,6	6,60	42,1	1,66	125,3	4,93	70,0
② 6S part #	Terminal End Hose Size	DN	Hose size	Thread	A		D		EØ		H		①
<b>6S24BFB24</b>	-24	38	-24	G 1 1/2	205,1	8,07	127,0	5,00	31,1	1,22	98,6	3,88	55,0
<b>6S32BFB32</b>	-32	51	-32	G 2	245,7	9,67	167,6	6,60	42,1	1,66	125,3	4,93	70,0

\*"G" as part of thread size is ISO designation for parallel thread.

Spiral – 4S and 6S series

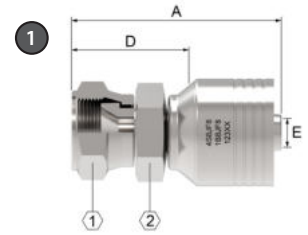

# JF

JIS Female swivel (30° flare seat straight)

PART 4S part #	HOSE SIZE INFO			DIMENSIONS									
	Terminal End Hose Size	DN	Hose size	Thread	A		D		EØ		1		2
					mm	in	mm	in	mm	in	mm	in	mm
<b>4S12JF12</b>	-12	19	-12	G 3/4	62,4	2.46	26,2	1.03	14,2	0.56	30,0	1 3/16	32,0
<b>4S16JF16</b>	-16	25	-16	G 1	66,6	2.62	26,8	1.06	19,2	0.76	41,0	1 5/8	41,0
<b>4S20JF20</b>	-20	31	-20	G 1 1/4	85,5	3.37	30,2	1.19	25,2	0.99	46,0	1 13/16	50,0

"G" as part of thread size is ISO designation for parallel thread.

## Weatherhead

Spiral – 4S and 6S series

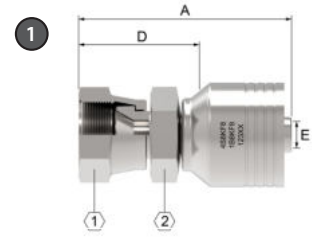

## KF

Komatsu female swivel (30° flare seat straight)

PART 4S part #	HOSE SIZE INFO			DIMENSIONS										
	Terminal End Hose Size	DN	Hose size	Thread	A		D		EØ		1		2	
					in	mm	in	mm	in	mm	in	mm	in	mm
<b>4S10KF10</b>	-10	16	-10	M24X1.5	72.1	2.84	46	1.81	12.4	.49	1 1/4	30		
<b>4S12KF12</b>	-12	19	-12	M30X1.5	62,4	2.46	26,2	1.03	14,2	0.56	30,0	1 3/16	36,0	
<b>4S16KF16</b>	-16	25	-16	M33X1.5	66,6	2.62	26,8	1.06	19,2	0.76	41,0	1 5/8	41,0	
<b>4S20KF20</b>	-20	31	-20	M36X1.5	85,5	3.37	30,2	1.19	25,2	0.99	46,0	1 13/16	46,0	

Spiral – 4S and 6S series

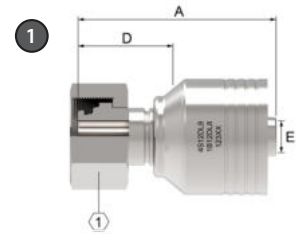

## DL

Female swivel DIN 24° seat (l.Rh DKO light straight)

PART ① 4S part #	HOSE SIZE INFO			DIMENSIONS							
	Tube O.D.	DN	Hose size	Thread	A		D		EØ		①
				mm	mm	in	in	mm	in	mm	in
<b>4S10DL6</b>	10	10	-6	M18X1.5	51.2	2.02	25.9	1.02	6.7	0.26	22
<b>4S12DL8</b>	12	12	-8	M22X1.5	58.3	2.3	28.6	1.13	9.6	0.38	27
<b>4S16DL10</b>	16	16	-10	M26X1.5	59.2	2.33	29.8	1.17	12.8	0.5	32
<b>4S20DL12</b>	22	19	-12	M30X2	76,0	2.99	39,7	1.56	14,2	0.56	36,0
<b>4S25DL16</b>	28	25	-16	M36X2	79,7	3.14	40,3	1.59	19,2	0.76	41,0
<b>4S32DL20</b>	35	35	-20	M45X2	100,5	3.96	45,5	1.79	25,2	0.99	50,0

## Weatherhead

Spiral – 4S and 6S series

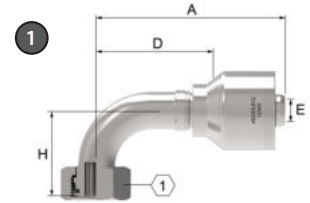

### DLB

I.Rh DKO (light) 90° elbow

PART	HOSE SIZE INFO			DIMENSIONS										
	4S part #	Tube O.D.	DN	Hose size	Thread	A		D		EØ		H		1
					mm	mm	in	in	mm	in	mm	in	mm	mm
<b>4S20DLB12</b>	22	19	-12	M30X2	106,1	4.18	69,8	1.75	14,2	0.56	50,7	2.00	36,0	
<b>4S32DLB20</b>	28	25	-20	M45X2	154,2	6.07	99,2	3.90	25.2	0.99	79,0	3.11	41,0	



Spiral – 4S and 6S series

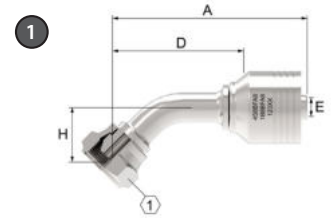

# EK

Male DIN 24° Seat Rigid (S.Rh. DKO - Heavy Straight)

PART	HOSE SIZE INFO			DIMENSIONS								
	4S part #	Tube O.D.	DN	Hose size	Thread	A		D		EØ		①
					in	mm	in	in	mm	in	mm	in
<b>4S6EK6</b>	6	10	-6	M18X1.5	45.5	1.79	24.2	0.95	6.7	0.26	19	
<b>4S20EK12</b>	25	19	-12	M36X2	78,6	3.09	42,3	1.67	14,2	0.56	41,0	
<b>4S25EK16</b>	30	25	-16	M42X2	83,7	3.30	44,0	1.73	19,2	0.75	46,0	
<b>4S32EK20</b>	38	31	-20	M52X2	106,9	4.21	51,7	2.04	25,2	0.99	55,0	

# Weatherhead

Spiral – 4S and 6S series

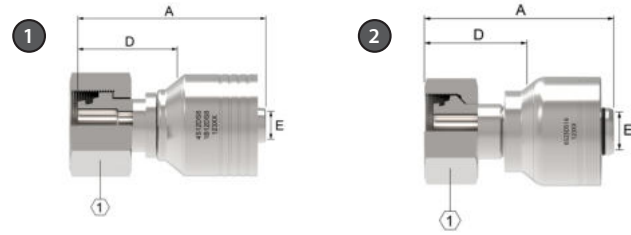

## DS

Female Swivel DIN 24° seat (S.RH. DKO - Heavy Straight)

PART	HOSE SIZE INFO			DIMENSIONS								
	4S part #	Tube O.D.	DN	Hose size	Thread	A		D		EØ		⊘
					mm	mm	in	in	mm	in	mm	mm
<b>1</b>												
<b>4S8DS6</b>	8	10	-6	M20X1.5	53.8	2.12	28.5	1.12	6.7	0.26	24	
<b>4S10DS6</b>	10	10	-6	M22X1.5	56.9	2.24	31.6	1.24	6.7	0.26	27	
<b>4S12DS8</b>	12	12	-8	M24X1.5	62.4	2.46	32.7	1.29	9.6	0.38	30	
<b>4S16DS10</b>	16	16	-10	M30X2	66.9	2.63	37.5	1.48	12.8	0.5	36	
<b>4S16DS12</b>	16	19	-12	M30X2	73,7	2.90	37,4	1.47	14,2	0.56	36,0	
<b>4S20DS12</b>	20	19	-12	M36X2	86,6	3.41	50,3	1.98	14,2	0.56	46,0	
<b>4S25DS12</b>	25	19	-12	M42X2	88,2	3.47	51,9	2.04	14,2	0.56	50,0	
<b>4S25DS16</b>	30	25	-16	M42X2	91,1	3.59	51,4	2.02	19,2	0.76	50,0	
<b>4S32DS16</b>	38	25	-16	M52X2	94,5	3.72	55,3	2.18	19,2	0.76	60,0	
<b>4S25DS20</b>	30	31	-20	M42X2	96,6	3.80	41,6	1.64	22,1	0.87	50,0	
<b>4S32DS20</b>	38	31	-20	M52X2	111,5	4.39	56,5	2.22	25,2	0.99	60,0	
<b>2</b>												
<b>6S part #</b>	Terminal End Hose Size	DN	Hose size	Thread	A		D		EØ		⊘	
<b>6S25DS16</b>	30	25	-16	M42X2	91,1	3.59	51,4	2.02	19,2	0.76	50,0	
<b>6S32DS16</b>	38	25	-16	M52X2	95,0	3.74	55,3	2.18	19,2	0.76	60,0	
<b>6S32DS20</b>	38	31	-20	M52X2	112,5	4.43	56,5	2.22	25,2	0.99	60,0	

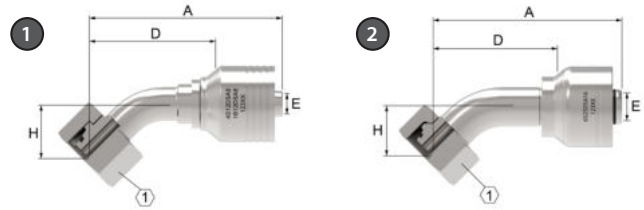

## DSA

Female Swivel DIN 24° Seat (S.Rh. DKO - Heavy 45° elbow)

PART	HOSE SIZE INFO			DIMENSIONS									
	Tube O.D.	DN	Hose size	Thread	A		D		EØ		H		①
① 4S part #					mm	in	in	mm	in	mm	in	mm	in
<b>4S12DSA8</b>	12	12	-8	M24X1.5	86.7	3.41	57	2.24	9.6	0.38	24	0.94	30
<b>4S16DSA10</b>	16	16	-10	M30X2	87.1	3.43	57.7	2.27	12	0.47	24.7	0.97	36
<b>4S20DSA12</b>	25	19	-12	M36X2	116,7	4.59	80,4	3.17	14,2	0.56	32,0	1.26	46,0
<b>4S25DSA12</b>	30	19	-12	M42X2	130,8	5.15	94,4	3.72	14,2	0.56	35,0	1.38	50,0
<b>4S25DSA16</b>	30	25	-16	M42X2	134,2	5.28	94,4	3.72	19,2	0.76	35,0	1.38	50,0
<b>4S32DSA16</b>	38	25	-16	M52X2	145,1	5.71	105,3	4.15	19,2	0.76	39,0	1.54	60,0
<b>4S32DSA20</b>	38	31	-20	M52X2	161,3	6.35	106,3	4.19	25,2	0.99	39,0	1.54	60,0
② 6S part #	Tube O.D.	DN	Hose size	Thread	A		D		EØ		H		①
<b>6S25DSA16</b>	30	25	-16	M42X2	134,1	5.28	94,4	3.72	19,2	0.76	35,0	1.38	50,0
<b>6S32DSA16</b>	38	25	-16	M52X2	145,1	5.71	105,3	4.15	19,2	0.76	39,0	1.54	60,0
<b>6S32DSA20</b>	38	31	-20	M52X2	162,4	6.39	106,3	4.19	25,2	0.99	39,0	1.54	60,0

# Weatherhead

Spiral – 4S and 6S series

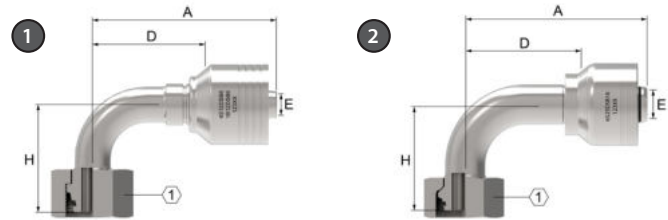

## DSB

Female Swivel DIN 24° Seat (S.Rh. DKO - Heavy 90° elbow)

PART		HOSE SIZE INFO			DIMENSIONS								
1 4S part #	Tube O.D.	DN	Hose size	Thread	A		D		EØ		H		1 in
					mm	mm	in	mm	in	mm	in	mm	
4S12DSB8	12	12	-8	M24X1.5	77.7	3.06	48	1.89	9.6	0.38	45.3	1.78	30
4S16DSB10	16	16	-10	M30X2	82	3.23	52.6	2.07	12.8	0.5	52	2.05	36
4S20DSB12	25	19	-12	M36X2	103,9	4.09	67,7	2.67	14,2	0.56	65,0	2.56	46,0
4S25DSB12	30	19	-12	M42X2	122,7	4.83	86,4	3.40	14,2	0.56	76,0	2.99	50,0
4S25DSB16	30	25	-16	M42X2	124,5	4.90	84,8	3.34	19,2	0.76	76,0	2.99	50,0
4S32DSB16	38	25	-16	M52X2	136,7	5.38	97,0	3.82	19,2	0.76	89,0	3.50	60,0
4S32DSB20	38	31	-20	M52X2	153,0	6.02	98,0	3.86	25,2	0.99	89,0	3.50	60,0
2 6S part #	Tube O.D.	DN	Hose size	Thread	A		D		EØ		H		1 in
					mm	mm	in	mm	in	mm	in	mm	
6S25DSB16	30	25	-16	M42X2	124,5	4.90	84,8	3.34	19,2	0.76	76,0	2.99	50,0
6S32DSB16	38	25	-16	M52X2	136,7	5.38	97,0	3.82	19,2	0.76	89,0	3.50	60,0
6S32DSB20	38	31	-20	M52X2	154,2	6.07	98,0	3.86	25,2	0.99	89,0	3.50	60,0

Weatherhead by Danfoss

# Spiral fittings

1W series



# Weatherhead

Spiral – 1W series

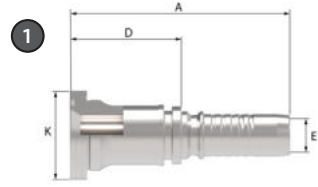

## FH

Straight SAE Code 62 Flange

PART	HOSE SIZE INFO				DIMENSIONS					
	1W part #	Flange head Dia. K Ø	DN	Hose size	A		D		EØ	
	mm	in			mm	in	in	mm	in	mm
<b>1W12FH12</b>	41,3	1.62	19	-12	110,6	4.35	58,6	2.31	15,1	0.59
<b>1W16FH16</b>	47,6	1.88	25	-16	134,0	5.28	67,4	2.65	19,6	0.77
<b>1W20FH20*</b>	54,0	2.13	31	-20	145,2	5.72	70,3	2.77	25,5	1.00
<b>1W24FH24*</b>	63,5	2.5	38	-24	203	7.99	104,5	4.11	30	1.18
<b>1W32FH32*</b>	79,4	3.126	51	-32	200,8	7.91	92,4	3.64	42,1	1.66

\* Requires separate installation of (2) O-rings  
 -20 p/n: 05.071-27.30x2.40  
 -24 p/n: 05.071-32.99x2.62  
 -32 p/n: 05.071-44.12x2.62  
 (must be ordered separately)

O-rings must be installed with PAG oil (only) prior to crimping.

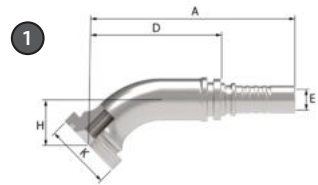

## FHA

45° SAE Code 62 Flange Elbow

PART	HOSE SIZE INFO				DIMENSIONS					
	1W part #	Flange head Dia. K Ø	DN	Hose size	A		D		H	
	mm	in			mm	in	mm	in	mm	in
<b>1W12FHA12</b>	41,3	1.62	19	-12	130,1	5.12	78,1	3.07	27,0	1.06
<b>1W16FHA16</b>	47,6	1.88	25	-16	160,6	6.32	94,0	3.70	31,0	1.22
<b>1W20FHA20*</b>	54,0	2.13	31	-20	190,0	7.48	115,1	4.53	39,0	1.54

\* Requires separate installation of (2) O-rings  
 -20 p/n: 05.071-27.30x2.40  
 (must be ordered separately).

O-rings must be installed with PAG oil (only) prior to crimping.

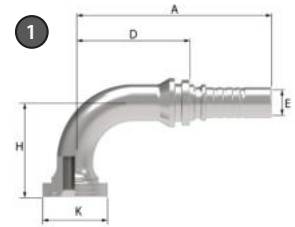

## FHB

90° SAE Code 62 Flange Elbow

PART	HOSE SIZE INFO				DIMENSIONS					
	1W part #	Flange head Dia. K Ø		DN	Hose size	A		D		EØ
	mm	in			mm	in	mm	in	mm	in
<b>1W12FHB12</b>	41,3	1.62	19	-12	124,8	4,91	72,8	2.87	59,0	2.32
<b>1W16FHB16</b>	47,6	1.88	25	-16	155,6	6.13	89,0	3.50	71,0	2.80
<b>1W20FHB20*</b>	54,0	2.13	31	-20	185,0	7.28	110,1	4.33	89,0	3.50

\* Requires separate installation of (2) O-rings  
-20 p/n: 05.071-27.30x2.40  
(must be ordered separately).  
O-rings must be installed with PAG oil (only) prior to crimping.

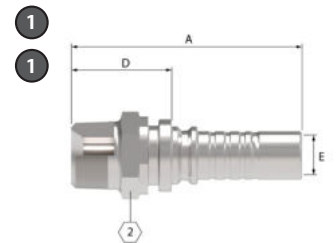

## MP

90° SAE Code 62 Flange Elbow

PART	HOSE SIZE INFO				DIMENSIONS							
	1W part #	Terminal hose end size		DN	Hose size	A		D		EØ		①
					mm	in	mm	in	mm	in	mm	
<b>1W12MP12</b>		-12	19	-12	3/4-14	92,1	3.63	40,1	1.58	15,1	0.59	30
<b>1W16MP16</b>		-16	25	-16	1-11 1/2	114,5	4.51	47,9	1.88	19,6	0.77	36

\* Requires separate installation of (2) O-rings  
-20 p/n: 05.071-27.30x2.40  
(must be ordered separately).  
O-rings must be installed with PAG oil (only) prior to crimping.

**Weatherhead**

Spiral – 1W series

**1W sockets**

Sockets for 1W fittings

Part  ① 1W part #	Hose size info		Dimensions			
	DN	Hose size	L		OD	
			mm	in	mm	in
<b>1WA12</b>	20	-12	52,1	2.05	43,1	1.70
<b>1WA16</b>	25	-16	66,5	2.62	48,8	1.92
<b>1WA20</b>	31	-20	77,7	3.06	57,2	2.25
<b>1WB24</b>	38	-24	96,6	3.80	70,6	2.78
<b>1WB32</b>	51	-32	107,1	4.22	87,6	3.45
<b>1WD12</b>	20	-12	57,0	2.24	42,1	1.66
<b>1WD16</b>	25	-16	67,5	2.66	51,4	2.02
<b>1WE20</b>	31	-20	78,7	3.10	63,5	2.50

## Socket type by hose

Part  ① Hose part #	Dimensions  Socket
<b>H600-12</b>	1WD12
<b>H600-16</b>	1WD16
<b>H600-20</b>	1WE20
<b>H600-24</b>	1WB24
<b>H600-32</b>	1WB32
<b>H850-10</b>	1WD10
<b>H850-12</b>	1WD12
<b>H850-16</b>	1WD16
<b>H850-20</b>	1WE20
<b>H464-12</b>	1WA12
<b>H464-16</b>	1WA16
<b>H464-20</b>	1WA20
<b>H464-24</b>	1WA24
<b>H464-32</b>	1WA32



Weatherhead by Danfoss

# Flange | Flange kit | O-rings



Split flange

# Split flanges

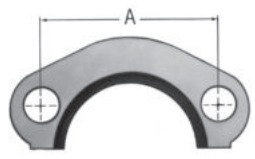

Danfoss has standard pressure series (code 61) and high pressure series (code 62) split flange components in kit form that save time in selecting and ordering. Each kit includes two flange halves, four grade-8 hex bolts, four lock washers and an O-Ring. The standard kit has a Buna-N 90 durometer O-Ring that is compatible with petroleum and water-base hydraulic fluids. Optional kits contain EPDM and Viton\* O-Ring for applications where fluid compatibility or high temperatures require other than Buna-N O-Ring.

\*Viton is a trademark of The Chemours Company FC, LLC

Two methods can be used to determine the flange dash size and code. The first is by measuring the flange head diameter on the fitting itself. This is referred to as the "K" dimension. The second is by measuring the "A" dimension on the flange or the flange port. Either will determine the dash size and the code since these dimensions are exclusive to either code 61 or code 62 split flange kits. See chart below for these dimensions. In some cases, split flange fittings are available for hoses which exceed the pressures listed; when ordering fittings or hose assemblies, the terminal end performance rating may reduce the overall rating of the assembly.

Split flange						
"A" Dim.	"K" Flange head diameter	Flange dash size	Maximum operating pressure*		Recommended bolt torque	
in	in	mm	bar	psi	lb-in	
Code 61						
1.50	1.19	-08	350,0	5000	175–225	
1.88	1.50	-12	350,0	5000	225–350	
2.06	1.75	-16	350,0	5000	325–425	
2.31	2.00	-20	280,0	4000	425–550	
2.75	2.38	-24	210,0	3000	550–700	
3.06	2.81	-32	210,0	3000	650–800	
3.50	3.31	-40	175,0	2500	950–1100	
4.19	4.00	-48	140,0	2000	1650–1800	
Code 62						
1.59	1.25	-08	420,0	6000	175–225	
2.00	1.63	-12	420,0	6000	300–400	
2.25	1.88	-16	420,0	6000	500–600	
2.62	2.12	-20	420,0	6000	750–900	
3.12	2.50	-24	420,0	6000	1400–1600	
3.81	3.12	-32	420,0	6000	2400–2600	

\*Per SAE J518 standard.

Many leakage problems can be avoided if the split flanges are properly assembled.

1. Clean all mating surfaces.
2. Lubricate the O-Ring.
3. Partially tighten each bolt in rotation until all are fully tightened to the recommended torque value.
1. Determine the dash size and the code.
2. Select O-Ring for fluid compatibility.
3. Order by kit number shown on pages 231-233.

## Split flange kits

SAE standard pressure series  
(Code 61) SAE J518

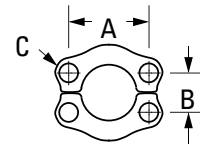
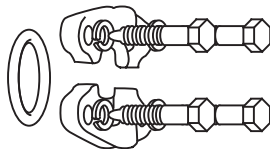

**O-Rings material:** Buna-N 90 Durometer  
**Temperature range:** -40°F to +250°F (-40°C to + 121°C)

### Split flange SAE standard pressure series

Nominal Flange Size	Complete Kit	*Flange halves 2 required	*Buna-N O-Ring 1 required	*Bolts 4 required	*Lock washer 4 required	A	B	C	Bolt torque lb.-in
1/2	<b>FF593-08</b>	449-74446-8	FF9446-210	FF9442-0520-94	210104-5S	1.50	0.68	0.34	175-225
3/4	<b>FF593-12</b>	449-74446-12	FF9446-214	FF9442-0620-94	210104-6S	1.88	0.88	0.41	250-350
1	<b>FF593-16</b>	449-74446-16	FF9446-219	FF9442-0620-94	210104-2-6S	2.06	1.04	0.41	325-425
1-1/4	<b>FF593-20</b>	449-74446-20	FF9446-222	FF9442-0724-94	210104-7S	2.31	1.18	0.48	425-550
1-1/2	<b>FF593-24</b>	449-74446-24	FF9446-225	FF9442-0824-94	210104-8S	2.75	1.40	0.53	550-700
2	<b>FF593-32</b>	449-74446-32	FF9446-228	FF9442-0824-94	210104-8S	3.06	1.68	0.53	650-800
2-1/2	<b>FF593-40</b>	449-74446-40	FF9446-232	FF9442-0828-94	210104-8S	3.50	2.00	0.53	950-1100
3	<b>FF593-48</b>	449-74446-48	FF9446-237	FF9442-1028-94	210104-10S	4.19	2.44	0.66	1650-1800

\* Included in kit.

\*Viton kit available as part # FF687-Size. EPDM kit available as part # FF688-size. See pg. 230 for Viton and EPDM O-Ring part numbers.

Note: All measurements in inches.

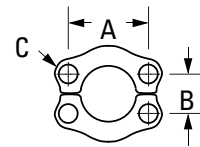
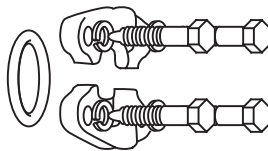

SAE high pressure series  
(Code 62) SAE J518

**O-Ring material:** Buna-N 90 Durometer  
**Temperature range:** -40°F to +250°F (-40°C to + 121°C)

### Split flange SAE high pressure series

Nominal Flange Size	Complete Kit	*Flange halves 2 required	*Buna-N O-Ring 1 required	*Bolts 4 required	*Lock washer 4 required	A	B	C	Bolt torque lb.-in
3/4	<b>FF595-12</b>	FC3425-12-449	FF9446-214	FF9442-0624-94	210104-6S	2.00	0.94	0.42	300-400
1	<b>FF595-16</b>	FC3425-16-449	FF9446-219	FF9442-0728-94	210104-7S	2.25	1.10	0.50	500-600
1-1/4	<b>FF595-20</b>	FC3425-20-449	FF9446-222	FF9442-0828-94	210104-8S	2.62	1.24	0.60	750-900
1-1/2	<b>FF595-24</b>	FC3425-24-449	FF9446-225	FF9442-1036-94	210104-10S	3.12	1.44	0.66	1400-1600
2	<b>FF595-32</b>	FC3425-32-449	FF9446-228	FF9442-1244-94	210104-12S	3.81	1.76	0.78	2400-2600

\* Included in kit.

\* Viton kit available as part #FF689-size. See page 230 for Viton O-Ring part numbers.

**Note:** All measurements in inches.

**Note:** Code 62 split flange kits cannot be used with Cat flange fittings. Use existing split flanges.

# Weatherhead

Split flange kits

## Split flange kits

4 hole flange  
SAE standard  
pressure series  
(Code 61) SAE J518

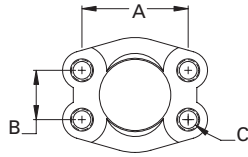

4-hole flange SAE standard pressure				
Nominal Flange Size	4 bolt flange	A	B	C (Threaded)
3/4	FC2119-12-449	1.88	0.88	3/8-16
1	FC2119-16-449	2.06	1.03	7/16-14
1-1/4	FC2119-20-449	2.31	1.19	3/8-16
1-1/2	FC2119-24-449	2.75	1.41	1/2-13
2	FC2119-32-449	3.06	1.69	1/2-13
2-1/2	FC2119-40-449	3.50	2.00	1/2-13

\*Available without threads as part #FC3459-size-449.

**NOTE:** All measurements in inches.

## O-Ring for SAE J518 Split flange

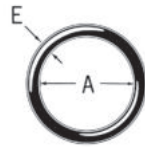

O-Ring for split flange		
O-Ring base #	Material	Operating temperature range
<b>FF9016</b> <b>EPDM</b>	80 Durometer	-65°F to +300°F (-55°C to +150°C)
<b>FF9446</b> <b>Buna-N</b>	90 Durometer Buna-N	-40°F to +250°F (-40°C to +121°C)
<b>22046</b> <b>Viton</b>	90 Durometer	-15°F to +400°F (-25°C to +205°C)

Available without threads part #FC3459-size-449.

O-Ring for split flange							
O-Ring dash size designation	Flange Dash Size	Nominal flange Size	A		E		
			mm	in	mm	in	
-210	08	1/2	18,5	0.734	3,5	0.139	
-214	12	3/4	24,9	0.984	3,5	0.139	
-219	16	1	32,9	1.296	3,5	0.139	
-222	20	1 1/4	37,7	1.484	3,5	0.139	
-225	24	1 1/2	47,2	1.859	3,5	0.139	
-228	32	2	56,7	2.234	3,5	0.139	
-232	40	2 1/2	69,4	2.734	3,5	0.139	
-237	48	3	85,3	3.359	3,5	0.139	

# O-Rings

## Cat flange D-Ring\*

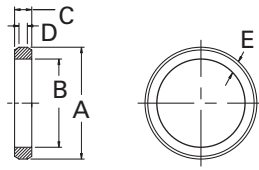

Cat flange D-Ring*										
Part #	A		B		C		D		E	
	mm	in	mm	in	mm	in	mm	in	mm	in
<b>FF90319-12</b>	32,3	1.27	25,4	1.00	5,1	0.20	2,5	0.10	3,6	0.14
<b>FF90319-16</b>	38,6	1.52	31,8	1.25	5,1	0.20	2,5	0.10	3,6	0.14
<b>FF90319-20</b>	45,0	1.77	38,1	1.50	5,1	0.20	2,5	0.10	3,6	0.14
<b>FF90319-24</b>	51,6	2.03	44,7	1.76	5,1	0.20	2,5	0.10	3,6	0.14
<b>FF90319-32</b>	70,6	2.78	64,0	2.52	5,1	0.20	2,5	0.10	3,6	0.14

Temperature range: -40°F to +212°F

Material: Nitrile (Buna-N).

\*To be used only with Cat flange.

## O-Rings for bump tube O-Ring seal and O-Ring pilot fitting

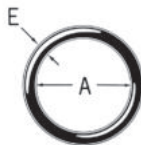

O-Rings for bump tube O-Ring seal and O-Ring pilot fitting					
Part #	O-Ring pilot dash size	A		E	
		mm	in	mm	in
<b>FF90319-12</b>	-06	7,6	0.30	1,8	0.07
<b>FF90319-16</b>	-08	10,9	0.43	1,8	0.07
<b>FF90319-20</b>	-10	14,0	0.55	1,8	0.07
<b>FF90319-24</b>	-12	17,3	0.68	1,8	0.07

O-Rings & Kits

**O-Rings**  
O-Ring seal kit  
FF16087-01



FF16087-01

- Metal box,
- O-Rings for ORS -4 through -24,
- O-Ring boss -04 through -32,
- Split flange -08 through -32,
- 24 packages with twelve 90 durometer nitrile O-Ring per package.

Replacement O-Ring can be ordered individually by part number listed.

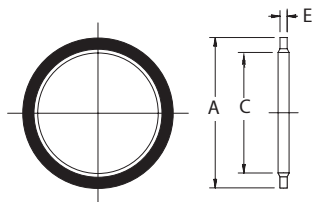

BSPP bonded seal for DIN 3852-2 ports  
FF9895

O-Ring seal kit

Connection	Size	Individual O-Ring part #
ORS	-04	<b>FF9446-11</b>
ORS	-06	<b>FF9446-12</b>
ORS	-08	<b>FF9446-14</b>
ORS	-10	<b>FF9446-16</b>
ORS	-12	<b>FF9446-18</b>
ORS	-16	<b>FF9446-21</b>
ORS	-20	<b>FF9446-25</b>
ORS	-24	<b>FF9446-29</b>
O-Ring Boss	-04	<b>22617-4</b>
O-Ring Boss	-05	<b>22617-5</b>
O-Ring Boss	-06	<b>22617-6</b>
O-Ring Boss	-08	<b>22617-8</b>
O-Ring Boss	-10	<b>22617-10</b>
O-Ring Boss	-12	<b>22617-12</b>
O-Ring Boss	-16	<b>22617-16</b>
O-Ring Boss	-20	<b>22617-20</b>
O-Ring Boss	-24	<b>22617-24</b>
O-Ring Boss	-32	<b>22617-32</b>
Split Flange	-08	<b>FF9446-210</b>
Split Flange	-12	<b>FF9446-214</b>
Split Flange	-16	<b>FF9446-219</b>
Split Flange	-20	<b>FF9446-222</b>
Split Flange	-24	<b>FF9446-225</b>
Split Flange	-32	<b>FF9446-228</b>

O-Ring for split flange

Bonded Seal Part #	BSPP Thread Size	A Ref	B Ref	C ref
	inch	inch	inch	inch
<b>FF9895-02</b>	1/8-28	0.625	0.403	0.080
<b>FF9895-04</b>	1/4-19	0.810	0.536	0.080
<b>FF9895-06</b>	3/8-19	0.937	0.675	0.080
<b>FF9895-08</b>	1/2-14	1.125	0.843	0.097
<b>FF9895-10</b>	5/8-14	1.250	0.920	0.097
<b>FF9895-12</b>	3/4-14	1.375	1.060	0.097
<b>FF9895-16</b>	1-11	1.685	1.329	0.133
<b>FF9895-20</b>	1 1/4-11	2.062	1.685	0.133
<b>FF9895-24</b>	1 1/2-11	2.307	1.902	0.133
<b>FF9895-32</b>	2-11	2.875	2.380	0.133

Material: steel with bonded nitrile (buna-n) seal.

## O-Rings & kits

Designating separate SAE O-Ring boss

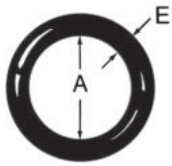

To order Danfoss O-Ring separately without fittings specify the size and material by using the O-Ring base number and dash size. The charts offer a simple method to assure the correct O-Ring for your application.

SAE O-Rings		
O-Ring Base #	Material	Operating temperature range
<b>22617 (Standard)</b>	Buna-N Nitrile rubber 90 Durometer	Buna-N Nitrile rubber 90 Durometer
<b>22033</b>	EPDM Ethylene propylene diene monomer	EPDM Ethylene propylene diene monomer
<b>22068</b>	Viton Fluoroelastomer 90 Durometer	Viton Fluoroelastomer 90 Durometer
<b>22012</b>	Buna-N, Low temperature nitrile rubber 90 Durometer	Buna-N, Low temperature nitrile rubber 90 Durometer

SAE O-Ring size					
O-Ring dash size	Tube size	A		E	
		mm	in	mm	in
-4	-04 (1/4)	8,9	0.351	1,8	0.072
-6	-06 (3/8)	11,9	0.468	2,0	0.078
-8	-08 (1/2)	16,3	0.644	2,3	0.087
-10	-10 (5/8)	19,3	0.755	2,5	0.097
-12	-12 (3/4)	23,4	0.924	3,0	0.116
-16	-16 (1)	29,7	1.171	3,0	0.116
-20	-20 (1 1/4)	37,6	1.475	3,0	0.118
-24	-24 (1 1/2)	43,7	1.720	3,0	0.118



**Weatherhead**

Split flange kit

## O-Rings & kits

Designating separate  
ORS O-Ring boss

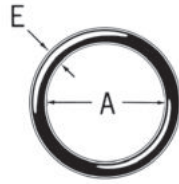

To order Danfoss O-Ring separately without fittings specify the size and material by using the O-Ring base number and dash size. The charts offer a simple method to assure the correct O-Ring for your application.

**ORS O-Rings**

O-Ring Base #	Material	Operating temperature range
<b>FF9446</b> <b>(Standard)</b>	Buna-N Nitrile Rubber 90 Durometer	-40°F to +250°F (-40°C to +121°C)
<b>FF9807</b>	EPDM Ethylene propylene diene monomer	-65°F to +300°F (-55°C to +150°C)
<b>22046</b>	Viton Fluoroelastomer 90 Durometer	-15°F to +400°F (-25°C to +205°C)
<b>FF9855</b>	Buna-N, Low Temperature Nitrile Rubber 90 Durometer	-65°F to +225°F (-55°C to +107°C)
<b>22546</b>	Neoprene 90 Durometer	-65°F to +300°F (-55°C to +150°C)

**ORS O-Ring size**

O-Ring dash size	Tube size	A		E	
		mm	in	mm	in
-11	-04	7,6	0.301	1,8	0.07
-12	-06	9,2	0.364	1,8	0.07
-14	-08	12,4	0.489	1,8	0.07
-16	-10	15,6	0.614	1,8	0.07
-18	-12	18,8	0.739	1,8	0.07
-21	-16	23,5	0.926	1,8	0.07
-25	-20	29,9	1.176	1,8	0.07
-29	-24	37,8	1.489	1,8	0.07



Weatherhead by Danfoss

## Hose accessories



# Weatherhead

Hose accessories

## Round-wire spring guard

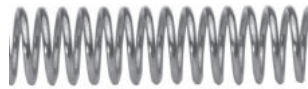

Spring guards should be considered for applications that call for tough, steel armor protection. They offer heavy-duty defense against cuts and abrasion, with the added benefit of kink resistance and the ability to mold hose assembly routing for applications requiring tight bends. Round-wire spring guards can be welded together for longer lengths.

Hot dipped Galvanized steel, chemically treated and oiled

see Accessories to hose chart pg 250 - 261

Round-wire spring guard				
Guard I.D.	Part #	Package length	Wire diameter	Pitch
0.532	<b>A1900</b>	100	0.063	0.188
0.532	<b>A1900-20</b>	20	0.063	0.188
0.532	<b>A1901</b>	100	0.063	0.188
0.532	<b>A1901-20</b>	20	0.063	0.188
0.610	<b>A1902</b>	100	0.063	0.188
0.610	<b>A1902-20</b>	20	0.063	0.188
0.660	<b>A1903</b>	100	0.080	0.188
0.660	<b>A1903-20</b>	20	0.080	0.188
0.750	<b>A1904</b>	100	0.080	0.188
0.750	<b>A1904-20</b>	20	0.080	0.188
0.840	<b>A1905</b>	100	0.080	0.188
0.840	<b>A1905-20</b>	20	0.080	0.188
0.910	<b>A1906</b>	100	0.080	0.188
0.910	<b>A1906-20</b>	20	0.080	0.188
0.990	<b>A1907</b>	100	0.080	0.188
0.990	<b>A1907-20</b>	20	0.080	0.188
1.048	<b>A1908</b>	100	0.080	0.188
1.048	<b>A1908-20</b>	20	0.080	0.188
1.180	<b>A1910</b>	100	0.080	0.250
1.180	<b>A1910-20</b>	20	0.080	0.250
1.340	<b>A1912</b>	60	0.105	0.375
1.642	<b>A1913</b>	60	0.120	0.375
1.880	<b>A1916</b>	60	0.120	0.375
2.125	<b>A1917</b>	40	0.120	0.375
2.300	<b>A1919</b>	40	0.120	0.375

## Flat-wire spring guard



Spring guards should be considered for applications that call for tough, steel armor protection. They offer heavy-duty defense against cuts and abrasion, with the added benefit of kink resistance and the ability to mold hose assembly routing for applications requiring tight bends.

1/4" width Galvanized steel

see Accessories to hose chart pg 250 - 261

Flat-wire spring guard					
Guard I.D.	Part #	Package length (ft.)	Strip thickness	Strip width	Pitch
0.500	<b>A2900</b>	100	0.028	0.250	0.37
0.570	<b>A2901</b>	100	0.028	0.250	0.37
0.625	<b>900705-25</b>	100	0.028	0.250	0.37
0.750	<b>900705-35</b>	100	0.028	0.250	0.37
0.875	<b>900705-45</b>	100	0.028	0.250	0.37
0.900	<b>A2906</b>	100	0.028	0.500	0.69
0.990	<b>A2907</b>	100	0.028	0.500	0.69
1.031	<b>A2908</b>	100	0.028	0.500	0.69
1.110	<b>A2909</b>	100	0.028	0.500	0.69
1.219	<b>A2910</b>	100	0.028	0.500	0.69
1.300	<b>A2911</b>	60	0.028	0.500	0.69
1.380	<b>A2912</b>	60	0.028	0.500	0.81
1.630	<b>A2913</b>	60	0.028	0.500	0.81
2.130	<b>A2917</b>	40	0.028	0.500	0.81
2.300	<b>A2919</b>	40	0.028	0.500	0.81

## Heavy-duty poly hose guard



Poly Hose ID

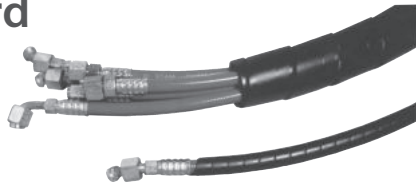

A heavy-duty hose guard can be easily placed around a single or bundle of hydraulic and pneumatic hose. It protects against abrasion and also provides crush resistance, reducing or eliminating costly premature hose failures.

High density Polyethylene

Resists oils, lubricants, gasoline and most solvents.

-100°F to +220°F

Black

see Accessories to hose chart pg 250 - 261

Heavy-duty poly hose guard				
Guard I.D.	Part #	Wall thickness	Guard O.D.	Roll length (ft)
0.492	<b>A9900</b>	.069	.630	100
0.668	<b>A9901</b>	.086	.840	100
1.014	<b>A9902</b>	.118	1.250	100
1.600	<b>A9903</b>	.150	1.900	50
2.457	<b>A9904</b>	.209	2.875	50
3.065	<b>A9905</b>	.218	3.500	35

## Locator clamps

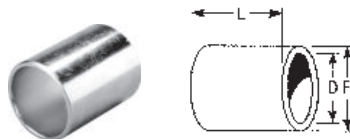

Locator clamps are designed for crimping to H14510 or H42510 hydraulic hose to provide a support for routing clamps. They are popular in Case® equipment applications.

Note: Crimp using collet T-400-5C and spacer ring T-400-62 (yellow), flat side up.

see Accessories to hose chart pg 250 - 261

Abrasion sleeve				
Hose I.D.	Part #	L	D	F
5/8	<b>A4910</b>	1.60	1.084	1.25

## Abrasion sleeve

MSHA Accepted ISO 6945



Abrasion sleeve is used to help safeguard hose covers from abrasions and cuts. The sleeve is also useful for bundling two or more hose assemblies together, adding to its protective qualities.

It is available in .045" thin-wall and .090" thick-wall sleeving.

Bulk continuous filament nylon

Agriculture

\* Slide sleeve onto the hose before assembling the fittings. After assembly, clamp the sleeve over the fittings.

Logging

Construction

Mining

see Accessories to hose chart pg 250 - 261

Abrasion sleeve				
Sleeve thin wall I.D.	.045" thin wall part #	.090" thick wall part #	Package length (ft)	I.D. (flat)
0.90	<b>A4900</b>	A3900	100	1.32-1.51
1.06	<b>A4901</b>	A3901	100	1.57-1.76
1.22	<b>A4902</b>	A3902	100	1.82-2.01
1.35	<b>A4903</b>	A3903	100	2.03-2.21
1.66	<b>A4904</b>	A3904	100	2.63-2.87
1.81	<b>A4905</b>	A3905	100	2.75-2.94
2.19	<b>A4906</b>	A3906	100	3.43-3.53
2.62	<b>A4907</b>	A3907	100	4.02-4.21
2.80	<b>A4908</b>	A3908	100	4.43-4.62

\*Package contains two pieces that are not less than 30 feet long each.

Note: Wall thickness is for single wall.

Note: Abrasion sleeve temp rating is 250°F.

## Weatherhead

Hose accessories

### Hose bend restrictors



For use in protecting the last section of hose at the fitting connection, bend restrictors are designed to allow for an appropriate degree of "bend" without compromising the integrity of hose assemblies. They are also recommended for hose assemblies that receive substantial handling, such as in pressure washer, air, oil, and hydraulic fluid transfer applications.

Plastisol MR 436 gloss PVC

see Accessories to hose chart pg 250 - 261

#### Bend restrictors

Restrictor I.D.	Part #	Restrictor length (inch)
0.530	<b>A5953</b>	6
0.625	<b>A5962</b>	6
0.690	<b>A5969</b>	6
0.750	<b>A5975</b>	7
0.840	<b>A5984</b>	7
0.875	<b>A5987</b>	7

\*Add "BG" to part number for bagged quantity of six

### Firesleeve



Firesleeve is a flame-resistant sheathing constructed of tightly woven fiberglass, which is coated with a specially compounded, highly temperature-resistant silicone rubber. Firesleeve offers protection in high temperature environments with heat extremes. It is not compatible with hydrocarbons.

Continuous exposure up to 500°F

Up to 2000°F for 15 to 20 minutes

Up to 3000°F for durations of 15 to 30 seconds

Red-orange

see Accessories to hose chart pg 250 - 261

#### Firesleeve

Sleeve I.D.	Part #	Roll length (ft)
0.50	<b>A6908</b>	100
0.63	<b>A6910</b>	100
0.75	<b>A6912</b>	100
0.88	<b>A6914</b>	100
1.00	<b>A6916</b>	100
1.25	<b>A6920</b>	100
1.50	<b>A6924</b>	100
1.75	<b>A6928</b>	100
2.00	<b>A6932</b>	50
2.25	<b>A6936</b>	50

### Firesleeve tape



**CAUTION**

Tests should be conducted to determine the suitability of Firesleeve for each application.

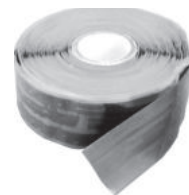

Firesleeve tape provides protection in high temperature environments. It acts as an end sealant in preventing moisture and hydraulic oils from wicking into the inner braids of Firesleeve.

High temperature-resistant, non-adhesive, silicone elastomer

+475°F continuous

#### Firesleeve tape

Tape coverage	Part #	Roll length
All sizes	<b>A6900W</b>	1x432

## Pressure gauge kit

FF14802



### Pressure gauge kit

Kit FF14802 Component Part #	Description	Quantity per kit
<b>FF14783</b>	1/8" NPT Test Coupling	2
<b>FF14784</b>	1/4" NPT Test Coupling	2
<b>FF14787</b>	7/16-20 UNF Test Coupling	1
<b>FF14788</b>	9/16-20 UNF Test Coupling	1
<b>FF14794</b>	1/4" NPT Gauge Adapter	3
<b>FF14796</b>	Union Adapter	2
<b>FF14798</b>	60" Test Hose Assembly	2
<b>FF14799</b>	(-) 30 in/Hg - 30 psi Gauge	1
<b>FF14800</b>	1,000 psi Gauge	1
<b>FF14801</b>	7,500 psi Gauge	1

## Thread measuring kit

FT1341



Measuring tube and pipe fitting threads can be a most difficult task if not completely understood. Tools needed include a thread pitch gauge, calipers and seat angle gauges. To aid you, Danfoss has a kit to fit your needs; the FT1341 thread measuring kit.

- Thread pitch gauge (Imperial and metric)
- Inside/outside caliper (inches and millimeters)
- 2 seat angle gauges (37°/45° and a 12°/30°)
- How to identify fluid ports and connectors bulletin
- Carrying case for easy and convenient storage

Weight: .5 lb.



## Band style clamp

FF9217

Recommended for attaching sleeve to hose lines.

### Clamp numbers:

FF9217- 0622S, FF9217-0648S;  
3/8 inch wide  
FF9217-0664C; 1/2 inch wide.

see Accessories to hose chart  
pg 250 - 261



## Band style clamp tool

F2636

Installation tool for FF9217 clamps. Recommended for attaching sleeve to hose lines.



## Assembly lube

222070 | 222070-8

Specially compounded petroleum based hose assembly lubricant.



# Weatherhead

Hose accessories

## Guardian Sleeve

FF90754



see Accessories to hose chart pg 250 - 261

FF90754		
Properties	Specification	Description
Burst pressure	16,000 psi	Capable to contain hose burst up to 16,000 psi
Pin hole leak pressure	4,000 psi	Sustained 4,000 psi pin hole deflection from focused 1mm pin hole
Abrasion cycles	250,000	Holds up to 250,000 abrasion cycles per ISO 6945

### General and dimensional information

Part #	Nominal I.D. (in)	A – Flat width (in) +/- 0.125	Weights in lbs per 300 ft Roll	Rolls per box
FF90754-68	0.68	1.290	7.43	8
FF90754-79	0.79	1.400	8.50	7
FF90754-91	0.91	1.590	9.70	6
FF90754-98	0.98	1.590	10.13	6
FF90754-106	1.06	1.825	11.10	5
FF90754-122	1.22	2.076	12.60	4
FF90754-142	1.42	2.390	14.50	4
FF90754-157	1.57	2.650	16.10	3
FF90754-173	1.73	2.910	17.70	3
FF90754-185	1.85	3.100	18.80	3
FF90754-209	2.09	3.470	21.10	2
FF90754-219	2.19	3.630	22.10	2
FF90754-238	2.38	3.925	23.90	2
FF90754-288	2.88	4.714	28.60	2
FF90754-366	3.66	5.938	36.10	1

### Guardian sleeve selection chart

Suggested sleeve part #	Sleeve I.D. (in)	Max hose OD that sleeve can accept (in)	Hose size as a ref.
FF90754-68	0.68	0.52	-4
FF90754-79	0.79	0.61	-4
FF90754-91	0.91	0.70	-6
FF90754-98	0.98	0.76	-6
FF90754-106	1.06	0.80	-6
FF90754-122	1.22	0.92	-8
FF90754-142	1.42	1.02	-10
FF90754-157	1.57	1.13	-10
FF90754-173	1.73	1.24	-12
FF90754-185	1.85	1.34	-16
FF90754-209	2.09	1.50	-16
FF90754-219	2.19	1.54	-20
FF90754-238	2.38	1.70	-20
FF90754-288	2.88	2.00	-20
FF90754-366	3.66	2.40	-24

Danfoss' Guardian Sleeve is designed to provide protection against hydraulic hose failure by containing pressure and fluids that may escape during a hose burst or pinhole leak.

1260

215°C/420°F

Polyamide 6, made with pre-dyed yarn

Great resistance to sun, atmospheric agents and aging

Non-Toxic

Black

Danfoss Guardian Sleeve comes in a 300 foot roll with no more than 3 cuts per roll and no piece shorter than 30 feet.

must be ordered by the roll.

### Guardian sleeve chemical compatibility

Chemical	Compatibility
Gasoline	Very Good
Oil	Very Good
Mineral and vegetable oil	Very Good
Ionic metallic solutions	Very Good
Alcohols	Very Good
Diluted bases	Very Good
Diluted acids *	Good
Benzene	Very Good
Acetone	Very Good
Ether	Very Good
Carbon Tetrachloride	Very Good
Chlorine based solvent	Very Good
Mold, bacteria, moths	Very Good

\*Strong and concentrated acids; ie. Hcl or Formic acid may have some corrosive action.

Select the correct sleeve part number for the hose.

Cut the sleeve 2 inches longer than the cut length of the hose to allow full hose bend radius.

The ends of the sleeves must be seared to prevent sleeve from fraying.

Slide the sleeve over the hose.

Properly assemble the hose ends.

Secure the sleeve over hose sockets with a metal banding product.

## Support Clamp



These lightweight vinyl-coated steel support clamps are designed to support hose where long runs are necessary. This clamp not only furnishes a cleaner installation, but prevents damage, exposure and chafing. The lining will withstand high ambient temperatures.

C1010 steel with 1/32" thick black vinyl cushion, Zinc-plated

**Note:** Vinyl coating will withstand 300°F for 2 hours or 180°F for 2000 hours.

see Accessories to hose chart pg 250 - 261

Support clamp		
Clamping diameter	Part #	Bolt hole
1/4	<b>HK0509</b>	13/32
3/8	<b>HK0709</b>	13/32
7/16	<b>HK0809</b>	13/32
1/2	<b>HK0913</b>	13/32
9/16	<b>HK1013</b>	13/32
5/8	<b>HK1113</b>	13/32
11/16	<b>HK1213</b>	13/32
3/4	<b>HK1313</b>	13/32
13/16	<b>HK1413</b>	13/32
7/8	<b>HK1513</b>	13/32
15/16	<b>HK1613</b>	13/32
1	<b>HK1713</b>	13/32
1-1/16	<b>HK1813</b>	13/32
1-1/8	<b>HK1913</b>	17/32
1-3/16	<b>HK2017</b>	17/32
1-1/4	<b>HK2117</b>	17/32
1-3/8	<b>HK2317</b>	17/32
1-1/2	<b>HK2517</b>	17/32
1-9/16	<b>HK2617</b>	17/32
1-3/4	<b>HK2917</b>	17/32
1-7/8	<b>HK3117</b>	17/32
1-15/16	<b>HK3217</b>	17/32
2	<b>HK3317</b>	17/32
2-1/8	<b>HK3417</b>	17/32
2-5/8	<b>HK3817</b>	17/32

\*Add **"BG"** to part number for bagged quantity of **ten**.

NOTE: Bagged quantity is **five** for HK2117, HK2317, HK2517, HK2917, HK3317, HK3817

## Heavy duty hose support clamps

FF90311

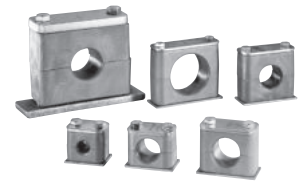

Heavy-duty weld-based clamps are designed to securely hold hose in applications subject to impulsing, flexing, and vibrating conditions.

The clamps help prevent abrasion and extend hose life through proper routing. Clamps are rated to ambient temperature of +250°F.

see Accessories to hose chart pg 250 - 261

FF90311		
Clamp Part #	Inside diameter	
	mm	in.
<b>FF90311-127</b>	12,7	0.50
<b>FF90311-137</b>	13,7	0.54
<b>FF90311-150</b>	15,0	0.59
<b>FF90311-160</b>	16,0	0.63
<b>FF90311-171</b>	17,1	0.67
<b>FF90311-174</b>	17,4	0.69
<b>FF90311-190</b>	19,0	0.75
<b>FF90311-205</b>	20,5	0.81
<b>FF90311-222</b>	22,2	0.87
<b>FF90311-239</b>	23,9	0.94
<b>FF90311-254</b>	25,4	1.00
<b>FF90311-266</b>	26,6	1.05
<b>FF90311-280</b>	28,0	1.10
<b>FF90311-300</b>	30,0	1.18
<b>FF90311-320</b>	32,0	1.26
<b>FF90311-334</b>	33,4	1.31
<b>FF90311-357</b>	35,7	1.41
<b>FF90311-381</b>	38,1	1.50
<b>FF90311-400</b>	40,0	1.57
<b>FF90311-422</b>	42,2	1.66
<b>FF90311-445</b>	44,5	1.75
<b>FF90311-483</b>	48,3	1.90
<b>FF90311-508</b>	50,8	2.00
<b>FF90311-635</b>	63,5	2.50
<b>FF90311-700</b>	70,0	2.76

# Weatherhead

Hose accessories

## Round-wire clamps

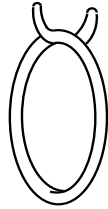

Carbon steel spring wire, Zinc plated.

- Industrial
- Automotive
- Agriculture
- General market applications

Round-wire clamps					
Clamp size	Hose size	Part #	Minimum diameter	Maximum diameter	Nominal diameter
06	1/4	1538	.370	.380	.375
08	5/16	1539	.551	.573	.562
10	3/8	1540	.610	.640	.625

## 6207 E.F.I. hose clamps

Electronic fuel injection hose clamps

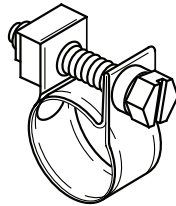

Plated carbon steel  
23/64" (9 mm) band width

6207 - E.F.I. hose clamps				
Clamp size	Part #	Minimum diameter	Maximum diameter	Nominal diameter
04	<b>6207-004</b>	.433	.551	.512
05	<b>6207-005</b>	.472	.590	.551
06	<b>6207-006</b>	.551	.669	.630

## Partial stainless steel clamps

Full-sized and micro-sized clamps SAE J1508 Type F

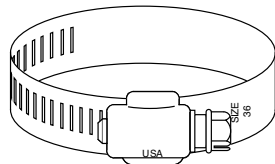

Partial stainless steel clamps utilize a 300 Series stainless steel band and housing with a steel case-hardened, zinc-plated screw. They feature a 14.3mm (9/16") band housing with a 8mm (5/16") hexagon and screwdriver slotted screw.

- Heavy-duty equipment
- Agriculture
- General industry

6205/6203 - Partial stainless steel clamps					
Clamp size	Part #	Minimum diameter	Maximum diameter	Nominal diameter	BG Bag Qty
*004	<b>6205-004</b>	7/32	5/8	1/4	10
*006	<b>6205-006</b>	5/16	7/8	1/2	10
006	<b>6203-006</b>	3/8	7/8	1/2	
008	<b>6203-008</b>	7/16	1	9/16	
010	<b>6203-010</b>	9/16	1-1/16	5/8	10
012	<b>6203-012</b>	9/16	1-1/4	3/4	10
016	<b>6203-016</b>	11/16	1-1/2	1	
020	<b>6203-020</b>	3/4	1-3/4	1-1/4	
024	<b>6203-024</b>	1-1/16	2	1-1/2	
028	<b>6203-028</b>	1-5/16	2-1/4	1-3/4	
032	<b>6203-032</b>	1-9/16	2-1/2	2	
036	<b>6203-036</b>	1-13/16	2-3/4	2-1/4	5
040	<b>6203-040</b>	2-1/16	3	2-1/2	5
044	<b>6203-044</b>	2-5/16	3-1/4	2-3/4	
048	<b>6203-048</b>	2-9/16	3-1/2	3	
052	<b>6203-052</b>	2-13/16	3-3/4	3-1/4	
056	<b>6203-056</b>	3-1/16	4	3-1/2	
064	<b>6203-064</b>	3-9/16	4-1/2	4	
072	<b>6203-072</b>	4-1/16	5	4-1/2	
080	<b>6203-080</b>	4-5/8	5-1/2	5	5
088	<b>6203-088</b>	4-3/32	6	5-1/2	
096	<b>6203-096</b>	4-1/2	6-1/2	6	
104	<b>6203-104</b>	5	7	6-1/2	5

\*Micro-sized clamps



## All stainless steel clamps

### Full-sized and micro-sized clamps SAE J1508 Type F

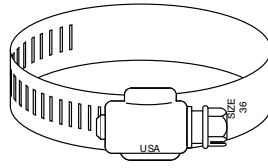

Clamps with an all stainless steel construction offers maximum protection against corrosion.

Full-sized all stainless clamps have a 14.3mm (9/16") band and housing manufactured with 300 Series stainless steel. The 8mm (5/16") hexagon and screwdriver slotted screw features 410 stainless steel.

Micro-sized all stainless clamps have a 5/16" (8mm) band and housing manufactured with 300 Series stainless steel. The 6.35mm (1/4") hexagon and screwdriver slotted screw features 410 stainless steel.

- Chemical
- Marine
- Food processing
- Dairy
- Automotive
- Electrical
- Plumbing

#### All stainless steel clamps

Clamp size	Part #	Minimum diameter	Maximum diameter	Nominal diameter	BG Bag Qty
*004	<b>6206-004</b>	7/32	5/8	1/4	10
*006	<b>6206-006</b>	5/16	7/8	1/2	10
006	<b>6204-006</b>	3/8	7/8	1/2	
008	<b>6204-008</b>	7/16	1	9/16	
010	<b>6204-010</b>	9/16	1-1/16	5/8	10
012	<b>6204-012</b>	9/16	1-1/4	3/4	
016	<b>6204-016</b>	11/16	1-1/2	1	
020	<b>6204-020</b>	3/4	1-3/4	1-1/4	
024	<b>6204-024</b>	1-1/16	2	1-1/2	
028	<b>6204-028</b>	1-5/16	2-1/4	1-3/4	
032	<b>6204-032</b>	1-9/16	2-1/2	2	10
036	<b>6204-036</b>	1-13/16	2-3/4	2-1/4	
040	<b>6204-040</b>	2-1/16	3	2-1/2	
044	<b>6204-044</b>	2-5/16	3-1/4	2-3/4	
048	<b>6204-048</b>	2-9/16	3-1/2	3	
052	<b>6204-052</b>	2-13/16	3-3/4	3-1/4	
056	<b>6204-056</b>	3-1/16	4	3-1/2	5
064	<b>6204-064</b>	3-9/16	4-1/2	4	
072	<b>6204-072</b>	4-1/16	5	4-1/2	
080	<b>6204-080</b>	4-5/8	5-1/2	5	
088	<b>6204-088</b>	4-3/32	6	5-1/2	
096	<b>6204-096</b>	4-1/2	6-1/2	6	
104	<b>6204-104</b>	5	7	6-1/2	

\*Micro-sized clamps

## Weatherhead

### Hose accessories

## HP Series

### Hose protectors



Easy installation in minutes – no need to remove hose, formulated to resist solvents, oils, grease and gasoline.

Hose protectors		
Part #	Description	Color
<b>HP4-B</b>	4" Hose protector case of 50	Black
<b>HP4-O</b>	4" Hose protector case of 50	Orange
<b>HP6-B</b>	6" Hose protector case of 50	Black
<b>HP6-O</b>	6" Hose protector case of 50	Orange
<b>HP8-B</b>	8" Hose protector case of 50	Black
<b>HP8-O</b>	8" Hose protector case of 50	Orange
<b>HP10-B</b>	10" Hose protector case of 10	Black
<b>HP10-O</b>	10" Hose protector case of 10	Orange
<b>HP12-B</b>	12" Hose protector case of 10	Black
<b>HP12-O</b>	12" Hose protector case of 10	Orange
<b>HPMB-60*</b>	Mixed hose protectors case of 60	Black
<b>HPMO-60*</b>	Mixed hose protectors case of 60	Orange

\*The HPM multi-pack contain 60 pieces, 20 of each size, -4, -6, and -8

- Operating temperature range is -40° to 430°F
- Exceptionally cost effective
- Packed in easy to assemble, colorful, counter display box
- Available in 5 sizes: -4, -6 -8 -10 & -12; cable ties included
- Farming
- Industrial
- Trucking
- Mining
- Construction
- Aviation support
- Road maintenance
- Waste management
- Original equip. manuf.

## HLM-48

### Hose looms



Hose looms	
Part #	Description
<b>HLM-48</b>	Case of 48 mixed hose looms

- Prevents hose abrasion at points of contact
- Keeps multiple hoses organized
- Simplifies hose routing
- Prevents damage from unrestrained hoses
- Available in 4 sizes – 3/4", 1", 1-1/8", 1-3/8"
- Packed in colorful counter display boxes of 48
- Also available in mixed boxes of 48 (12 each size) or refill bags of 12

## HSM-48

### Hose spacers



Hose spacers	
Part #	Description
<b>HSM-48</b>	Case of 48 mixed Hose Spacers

- Prevents hose abrasion at points of contact
- Helps keep hoses organized
- Prevents damage from unrestrained hoses
- Available in 4 sizes – 3/4", 1", 1-1/8", 1-3/8"
- Packed in colorful counter display boxes of 48 – cable ties included
- Also available in mixed boxes of 48 (12 each size) or refill bags of 12

## FF90308

### Hose insertion gauge



Improve hose assembly reliability with these easy to use aluminum gauges that are designed to ensure proper fitting depth during pre-assembly.

Simply bottom the hose in the appropriately marked cavity and scribe a mark on the hose flush with the top surface of the gauge. Insert the fitting until the back of the socket is aligned with scribe line.

Hose insertion gauge	
Part #	Usage
<b>FF90308-01</b>	For use with all hoses that mate with -4 through -16 1A (TTC)/Z series
<b>FF90308-02</b>	For use with all hoses that mate with -20 through -32 1A (TTC)/Z series
<b>FF90308-04</b>	For use with all hoses that mate with -06, -08, -10, -12, -16 spiral 4S/6S fittings
<b>FF90308-05</b>	For use with all hoses that mate with -20, -24, -32 spiral 4S/6S fittings

# Flaretite seals

The ideal product to enhance new installations of SAE 37° connections, as well as seal off minor leaks and weeping connections.



- Ribbed insert design
- Coated with Loctite sealant
- Economical method to reduce minor leaks and weeping connections
- Built-in clip to attach the Flaretite seal to the nose of the SAE 37 degree connection
- Available sizes: -04 through -32
- Multiple surface contact points
- Locks the joint and fills surface imperfections
- Saves time & money associated with maintenance and rework
- Quick & easy assembly

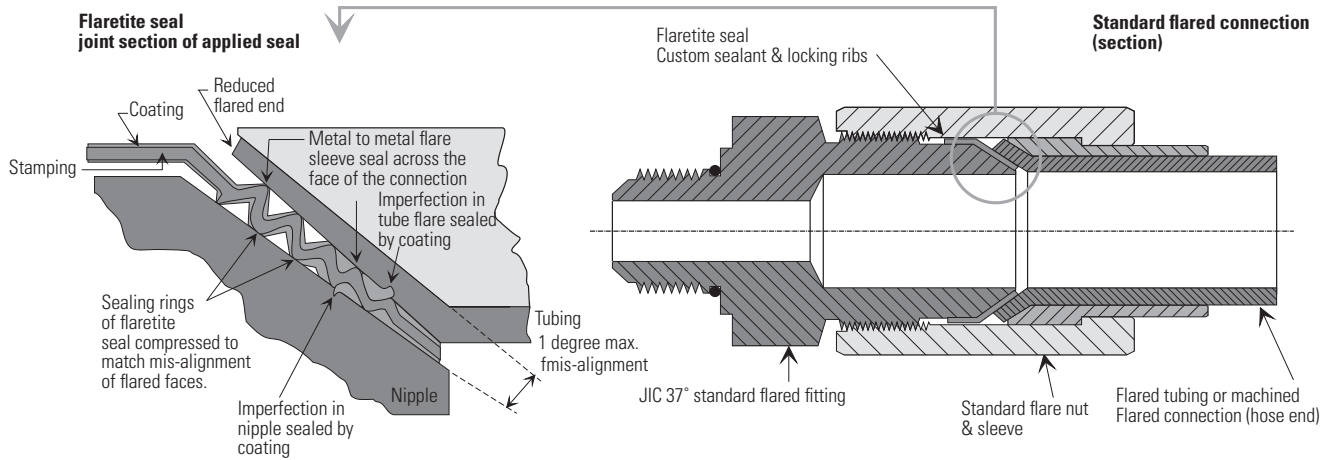

Error calculation for a 37 degree jic 1/2" connection

Flaretite seals		
Seal size	Package part #	Number of seals per package
-04	<b>FF13267</b>	100
-06	<b>FF13268</b>	100
-08	<b>FF13269</b>	100
-10	<b>FF13270</b>	100
-12	<b>FF13271</b>	100
-16	<b>FF13272</b>	50
-20	<b>FF13273</b>	50
-24	<b>FF13570</b>	25
-32	<b>FF13571</b>	10

To assemble an SAE 37° connection using a Flaretite seal, simply push the Flaretite seal onto the male portion of the connection. The built-in clip will hold the Flaretite seal onto the male half.

**During assembly ensure:**

- The seal is fitted squarely to the conical nose of the JIC fitting -37° flare.
- The sealing faces of the flared connector part are clean and free of burrs.
- The flared joint is correctly tightened with recommended torque settings noted below.

**Recommended torque settings:**

Tolerance: +10% -0%

-04 (1/4")	SAE 37°: 14lb-ft.	-10 (5/8")	SAE 37°: 80lb-ft.	-20 (1-1/4")	SAE 37°: 190lb-ft.
-06 (3/8")	SAE 37°: 26lb-ft.	-12 (3/4")	SAE 37°: 110lb-ft.	-24 (1-1/2")	SAE 37°: 220lb-ft.
-08 (1/2")	SAE 37°: 55lb-ft.	-16 (1")	SAE 37°: 140lb-ft.	-32 (2")	SAE 37°: 325lb-ft.

\* Flaretite is a registered trademark of Flaretite Inc. All photos and the name Flaretite are the property of Flaretite Inc.

\*\* Loctite is a registered trademark of the Henkel Corporation.

## Weatherhead

Hose protection

### Bundling sleeves



Hydraulic lines are often subjected to tremendous stress and wear during use. Lines that are allowed to move freely are easily abraded, crimped, or cut. Common methods for binding hydraulic lines, such as cable ties, can restrict movement too much as the lines expand and contract.

Bundling sleeves hold lines securely in place to protect them from damage, while providing enough flexibility for normal operation.

The sleeves can be removed and replaced quickly, allowing easy access for hose repair.

Bundling sleeve specifications						
Part #	Fits bundle outer diameter	Circumference of bundle to be covered (laid flat)	Sleeve width	Bulk roll length (ft)	Length tolerance	
<b>A4926</b>	2	6.0	7-3/4	150	(+1 ft., - 0 ft)	
<b>A4927</b>	3	9.4	11	150	(+1 ft., - 0 ft)	
<b>A4928</b>	4	12.5	14	150	(+1 ft., - 0 ft)	

Part numbers above are stocked in 150 foot shrink – wrapped bulk rolls, as rolled up and unfastened

Orders the number of rolls needed, not footage.

150 foot bulk rolls are one continuous length.

Order per foot

1050 Ballistic nylon, .71 mm thickness

Urethane coating

Black

175° F

Tight bundling and secure hose containment  
Resistant to heat, ozone, and abrasion  
Easy removal and replacement

Increase productivity in assembly and reassembly of hose bundles

Reduce contamination of hose during bundle assembly

Force routing of hydraulic lines for safety and efficiency

Reduce risk of hose bursts, resulting in greater operator safety

Reduce time spent on field repairs

Replace inefficient bundling methods and line-damaging cable ties

Eliminate cumbersome winding of spiral-formed products

Reduce old-sock-syndrome bunching at end of bundled lines

Eliminate line contamination during hose replacement

## Bundling straps

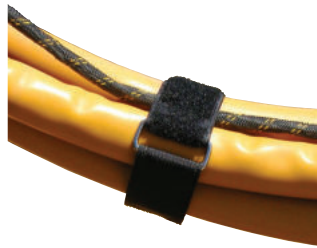

Bundling straps hold hose, cables, pipes, tubes, and other items securely in place. They can be removed, adjusted, and put back in place easily.

Unlike cable ties, bundling straps allow hose and tubes to expand and contract in changing conditions. Cable ties cannot be reused. Bundling straps, however, can be used again and again, with no loss of strength. Their hook-and-loop fasteners, developed for industrial applications, the safety industry, and the military, have superior sheer strength and peel compared to those used in the garment industry.

**Cinching strap (CS Series)** bundling straps are designed for economical service applications, such as hose and cable bundling. All joints are ultrasonically welded and tested.

**Hanging strap (HS Series)** bundling straps are held in place by a 3/8" grommet. The straps can be mounted vertically or horizontally.

Both cinching and hanging straps are available in standard duty or heavy duty. Heavy-duty bundling straps are designed for severe industrial applications and ultrasonically welded to 1-1/2" hook-and-loop material. All heavy-duty hardware is nickel-plated steel.

Bundling straps are sold in packages of five, and discounts are offered for volume quantities of 50, 100, 250, 500, and 1,000. Special sizes, materials, colors, and configurations are available. Ordering information on next page.

1050 Ballistic nylon II webbing, .71 mm thickness with dense nylon backing

Delrin plastic fastening loop on cinch and hanging straps

Urethane coating

1000 nylon webbing, 3.18 mm thickness with dense nylon backing

Nickel-plated steel 12 L.14 fastening loop on cinch and hanging straps

Urethane coating

Black

-40° to +250° F

Easy to remove and replace  
Adjustable to any size bundle  
Industrial strength strap fabric and fasteners  
Secure containment of hose, cables, and other items  
Clean professional appearance

Reduce cost of managing cables and hose  
Improve worker safety and productivity  
Reduce abrasion of bundles items  
Save money through reusability

## Weatherhead

Hose protection

### Bundling straps (cont.)



Bulk packed or  
Individually wrapped

Cinch straps						
Standard duty		Heavy duty		Circumference of hose bundle	Strap length (flat)	Ordering measurement
Bulk packed	Individually cellophane wrapped	Bulk packed	Individually cellophane wrapped			
Part #	Part #	Part #	Part #			
<b>FF90519-8</b>	<b>FF90520-8</b>	<b>FF90521-8</b>	<b>FF90522-8</b>	8"	14"	Each
<b>FF90519-12</b>	<b>FF90520-12</b>	<b>FF90521-12</b>	<b>FF90522-12</b>	12"	20-3/8"	Each
<b>FF90519-16</b>	<b>FF90520-16</b>	<b>FF90521-16</b>	<b>FF90522-16</b>	16"		Each
<b>FF90519-20</b>	<b>FF90520-20</b>	<b>FF90521-20</b>	<b>FF90522-20</b>	20"		Each

## Bundling straps (cont.)

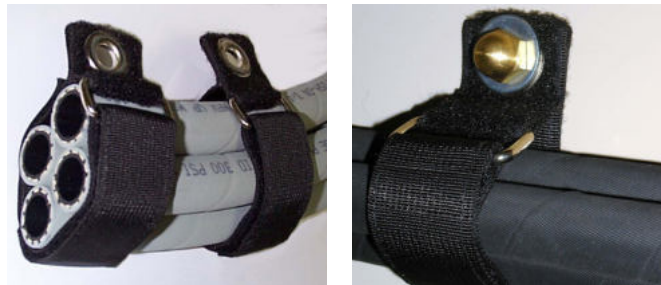











Bulk packed or Individually wrapped











Hanging straps						
Standard duty		Heavy duty		Circumference of hose bundle	Strap length (flat)	Ordering measurement
Bulk packed	Individually cellophane wrapped	Bulk packed	Individually cellophane wrapped			
Part #	Part #	Part #	Part #			
<b>FF90523-8</b>	<b>FF90524-8</b>	<b>FF90525-8</b>	<b>FF90526-8</b>	8"	14"	Each
<b>FF90523-12</b>	<b>FF90524-12</b>	<b>FF90525-12</b>	<b>FF90526-12</b>	12"	20-3/8"	Each
<b>FF90523-16</b>	<b>FF90524-16</b>	<b>FF90525-16</b>	<b>FF90526-16</b>	16"		Each
<b>FF90523-20</b>	<b>FF90524-20</b>	<b>FF90525-20</b>	<b>FF90526-20</b>	20"		Each

WARNING: Do not use this product for overhead lifting, support of human weight or athletic equipment, or other situations where personal safety or valuable property can be endangered.











## Accessories to hose chart











Match accessories to hose										
Hose Part #	Hose clamp	Heavy duty hose clamp	Round-wire spring guard	Flat-wire spring guard	Nylon (.045) abrasion sleeve	Nylon (.090) abrasion sleeve	Silicone fiberglass Firesleeve	Poly hose guard	Guardian sleeve*	Bend restrictor
										
2807-3	HK0709	-	A1901	A2900	A4900	A3900	A6908	A9900	FF90754-68	A5953
2807-4	HK0709	-	A1901	A2900	A4900	A3900	A6908	A9900	FF90754-68	A5953
2807-5	HK0809	-	A1901	A2900	A4900	A3900	A6908	A9900	FF90754-68	A5953
2807-6	HK0913	-	A1901	A2901	A4900	A3900	A6908	A9900	FF90754-68	A5953
2807-8	HK1113	FF90311-137	A1902	A2902	A4900	A3900	A6910	A9901	FF90754-79	A5962
2807-10	HK1213	FF90311-160	A1904	A2904	A4900	A3900	A6912	A9902	FF90754-91	A5969
2807-12	HK1413	FF90311-190	A1905	A2905	A4900	A3900	A6914	A9902	FF90754-122	A5984
2807-16	HK1913	FF90311-266	A1912	A2909	A4902	A3902	A6920	A9903	FF90754-157	-
2807-20	HK2317	FF90311-334	A1912	A2912	A4904	A3904	A6926	A9903	FF90754-288	-
3TR7-02	HK0509	-	A1901	A2900	A4900	A3900	A6910	A9900	FF90754-91	A5953
3TR7-03	HK0709	-	A1901	A2900	A4900	A3900	A6911	A9900	FF90754-98	A5953
3TR7-04	HK0809	-	A1901	A2900	A4900	A3900	A6912	A9900	FF90754-106	A5953
3TR7-05	HK1013	FF90311-137	A1902	A2902	A4900	A3900	A6913	A9901	FF90754-142	A5962
3TR7-06	HK1113	FF90311-160	A1903	A2904	A4900	A3900	A6916	A9901	FF90754-142	A5969
3TR7-08	HK1413	FF90311-205	A1905	A2905	A4902	A3902	A6918	A9902	FF90754-173	A5987
3TR7-10	HK1513	FF90311-222	A1907	A2907	A4902	A3902	A6920	A9902	FF90754-185	-
3TR7-12	HK1713	FF90311-254	A1908	A2909	A4903	A3903	A6922	A9903	FF90754-209	-
3TR7-16	HK2317	FF90311-334	A1912	A2912	A4904	A3904	A6926	A9903	FF90754-288	-
3TR7N-03	HK0709	-	A1901	A2900	A4900	A3900	A6911	A9900	FF90754-98	A5953
3TR7N-04	HK0809	-	A1901	A2900	A4900	A3900	A6912	A9900	FF90754-106	A5953
3TR7N-05	HK1013	FF90311-137	A1902	A2902	A4900	A3900	A6913	A9901	FF90754-142	A5962
3TR7N-06	HK1113	FF90311-160	A1903	A2904	A4900	A3900	A6916	A9901	FF90754-142	A5969
3TR7N-08	HK1413	FF90311-205	A1905	A2905	A4902	A3902	A6918	A9902	FF90754-173	A5987
3TR7N-10	HK1513	FF90311-222	A1907	A2907	A4902	A3902	A6920	A9902	FF90754-185	-
3TR7N-12	HK1713	FF90311-254	A1908	A2909	A4903	A3903	A6922	A9903	FF90754-209	-
3TR7N-16	HK2317	FF90311-334	A1912	A2912	A4904	A3904	A6926	A9903	FF90754-288	-
3TR8-04	HK1013	FF90311-137	A1902	A2902	A4900	A3900	A6914	A9901	FF90754-142	A5962
3TR8-06	HK1213	FF90311-174	A1905	A2905	A4901	A3901	A6916	A9902	FF90754-157	A5984
3TR8-08	HK1513	FF90311-222	A1906	A2907	A4902	A3902	A6920	A9902	FF90754-185	-
3TR8-12	HK1913	FF90311-280	A1910	A2910	A4904	A3904	A6922	A9903	FF90754-219	-
3TR8-16	HK2317	FF90311-357	A1913	A2913	A4904	A3904	A6928	A9903	FF90754-288	-
3TR8N-04	HK1013	FF90311-137	A1902	A2902	A4900	A3900	A6914	A9901	FF90754-142	A5962
3TR8N-06	HK1213	FF90311-174	A1905	A2905	A4901	A3901	A6916	A9902	FF90754-157	A5984
3TR8N-08	HK1513	FF90311-222	A1906	A2907	A4902	A3902	A6920	A9902	FF90754-185	-
3TR8N-12	HK1913	FF90311-280	A1910	A2910	A4904	A3904	A6922	A9903	FF90754-219	-
3TR8N-16	HK2317	FF90311-357	A1913	A2913	A4904	A3904	A6928	A9903	FF90754-288	-
3TR18CT-04	HK0809	-	A1901	A2900	A4900	A3900	A6912	A9900	FF90754-106	A5953
3TR18CT-05	HK1013	FF90311-137	A1902	A2902	A4900	A3900	A6914	A9901	FF90754-142	A5962
3TR18CT-06	HK1113	FF90311-160	A1904	A2904	A4900	A3900	A6916	A9901	FF90754-142	A5969
3TR18CT-08	HK1413	FF90311-205	A1906	A2905	A4902	A3902	A6918	A9902	FF90754-173	A5987
3TR18CT-10	HK1713	FF90311-266	A1910	A2909	A4903	A3903	A6922	A9903	FF90754-209	-













Match accessories to hose										
Hose clamp	Heavy duty hose clamp	Round-wire spring guard	Flat-wire spring guard	Nylon (.045) abrasion sleeve	Nylon (.090) abrasion sleeve	Silicone fiberglass Firesleeve	Poly hose guard	Guardian sleeve*	Bend restrictor	
										
Hose Part #										
<b>8008</b>	HK1513	FF90311-205	A1905	A2905	A4900	A3900	A6914	A9902	FF90754-122	A5987
<b>8012</b>	HK1913	FF90311-280	A1912	A2910	A4902	A3902	A6920	A9903	FF90754-157	-
<b>8016</b>	HK2317	FF90311-334	A1913	A2912	A4904	A3904	A6924	A9903	FF90754-209	-
<b>8020</b>	HK2917	FF90311-400	A1913	A2913	A4904	A3904	A6928	A9904	FF90754-238	-
<b>8024</b>	HK3117	FF90311-445	A1916	A2917	A4906	A3906	A6932	A9904	FF90754-288	-
<b>8032</b>	HK3817	FF90311-572	-	-	A4907	A3907	A6948	A9904	-	-
<b>8508</b>	HK1513	FF90311-205	A1905	A2905	A4900	A3900	A6914	A9902	FF90754-122	A5987
<b>8512</b>	HK1913	FF90311-280	A1912	A2910	A4902	A3902	A6920	A9903	FF90754-157	-
<b>8516</b>	HK2317	FF90311-334	A1913	A2912	A4904	A3904	A6924	A9903	FF90754-209	-
<b>8520</b>	HK2917	FF90311-400	A1913	A2913	A4904	A3904	A6928	A9904	FF90754-238	-
<b>8524</b>	HK3117	FF90311-445	A1916	A2917	A4906	A3906	A6932	A9904	FF90754-288	-
<b>8532</b>	HK3817	FF90311-572	-	-	A4907	A3907	A6948	A9904	-	-
<b>EC038-04</b>	HK1213	FF90311-150	A1904	A2904	A4900	A3900	A6912	A9902	FF90754-91	A5969
<b>EC038-06</b>	HK1413	FF90311-174	A1905	A2905	A4900	A3900	A6914	A9902	FF90754-106	A5984
<b>EC038-08</b>	HK1613	FF90311-205	A1907	A2907	A4901	A3901	A6916	A9902	FF90754-122	-
<b>EC115-04</b>	HK0809	FF90311-127	A1901	A2901	A4900	A3900	A6912	A9901	FF90754-106	A5953
<b>EC115-05</b>	HK0913	FF90311-127	A1902	A2901	A4900	A3900	A6913	A9901	FF90754-122	A5962
<b>EC115-06</b>	HK1113	FF90311-150	A1903	A2904	A4900	A3900	A6914	A9901	FF90754-142	A5969
<b>EC115-08</b>	HK1313	FF90311-190	A1905	A2905	A4902	A3902	A6918	A9902	FF90754-157	A5984
<b>EC115-10</b>	HK1513	FF90311-222	A1906	A2906	A4902	A3902	A6918	A9902	FF90754-173	-
<b>EC115-12</b>	HK1713	FF90311-254	A1908	A2908	A4903	A3903	A6922	A9903	FF90754-209	-
<b>EC115-16</b>	HK2317	FF90311-334	A1912	A2912	A4904	A3904	A6926	A9903	FF90754-288	-
<b>EC115-20</b>	HK2617	FF90311-400	A1913	A2913	A4905	A3905	A6930	A9904	FF90754-288	-
<b>EC115-24</b>	HK3117	FF90311-445	A1917	A2917	A4906	A3906	A6936	A9904	FF90754-366	-
<b>EC115-32</b>	HK3417	FF90311-572	-	-	A4907	A3907	A6946	A9904	-	-
<b>EC116-04</b>	HK0809	-	A1901	A2900	A4900	A3900	A6912	A9900	FF90754-106	A5953
<b>EC116-05</b>	HK0913	FF90311-137	A1902	A2901	A4900	A3900	A6913	A9901	FF90754-122	A5962
<b>EC116-06</b>	HK1013	FF90311-150	A1903	A2902	A4900	A3900	A6914	A9901	FF90754-142	A5969
<b>EC116-08</b>	HK1313	FF90311-190	A1905	A2905	A4901	A3901	A6916	A9902	FF90754-157	A5984
<b>EC118-04</b>	HK0809	-	A1901	A2900	A4900	A3900	A6912	A9900	FF90754-106	A5953
<b>EC118-05</b>	HK0913	FF90311-137	A1902	A2901	A4900	A3900	A6913	A9901	FF90754-122	A5962
<b>EC118-06</b>	HK1113	FF90311-150	A1903	A2904	A4900	A3900	A6914	A9901	FF90754-142	A5969
<b>EC118-08</b>	HK1313	FF90311-190	A1905	A2905	A4902	A3902	A6918	A9902	FF90754-157	A5984
<b>EC118-10</b>	HK1613	FF90311-239	A1907	A2907	A4902	A3902	A6920	A9902	FF90754-185	-
<b>EC118-12</b>	HK1913	FF90311-280	A1910	A2910	A4904	A3904	A6922	A9903	FF90754-219	-
<b>EC118-16</b>	HK2317	FF90311-357	A1913	A2913	A4904	A3904	A6928	A9903	FF90754-288	-
<b>EC215-04</b>	HK0913	FF90311-127	A1901	A2901	A4900	A3900	A6913	A9901	FF90754-122	A5962
<b>EC215-05</b>	HK1013	FF90311-150	A1902	A2902	A4900	A3900	A6914	A9901	FF90754-142	A5962
<b>EC215-06</b>	HK1213	FF90311-171	A1904	A2904	A4901	A3901	A6916	A9902	FF90754-157	A5975
<b>EC215-08</b>	HK1413	FF90311-205	A1905	A2905	A4902	A3902	A6918	A9902	FF90754-173	A5987
<b>EC215-10</b>	HK1613	FF90311-222	A1907	A2907	A4902	A3902	A6920	A9902	FF90754-185	-











Accessories to hose chart

Match accessories to hose										
Hose Part #	Hose clamp	Heavy duty hose clamp	Round-wire spring guard	Flat-wire spring guard	Nylon (.045) abrasion sleeve	Nylon (.090) abrasion sleeve	Silicone fiberglass Firesleeve	Poly hose guard	Guardian sleeve*	Bend restrictor
										
<b>EC215-12</b>	HK1813	FF90311-266	A1910	A2909	A4904	A3904	A6922	A9903	FF90754-209	-
<b>EC215-16</b>	HK2317	FF90311-334	A1913	A2913	A4904	A3904	A6928	A9903	FF90754-288	-
<b>EC215-20</b>	HK2617	FF90311-422	A1916	A2917	A4906	A3906	A6932	A9904	FF90754-366	-
<b>EC215-24</b>	HK3317	FF90311-508	A1917	A2917	A4907	A3907	A6936	A9904	FF90754-366	-
<b>EC215-32</b>	HK3417	FF90311-572	-	-	A4908	A3908	A6946	A9905	-	-
<b>EC216-04</b>	HK0913	FF90311-127	A1902	A2901	A4900	A3900	A6913	A9901	FF90754-122	A5962
<b>EC216-05</b>	HK1013	FF90311-137	A1902	A2902	A4900	A3900	A6914	A9901	FF90754-142	A5962
<b>EC216-06</b>	HK1213	FF90311-160	A1904	A2904	A4901	A3901	A6916	A9902	FF90754-157	A5975
<b>EC216-08</b>	HK1413	FF90311-190	A1905	A2905	A4902	A3902	A6918	A9902	FF90754-173	A5987
<b>EC415-06</b>	HK1313	-	A1905	A2905	A4902	A3902	A6918	A9902	FF90754-173	A5984
<b>EC415-08</b>	HK1613	FF90311-239	A1907	A2907	A4902	A3902	A6920	A9902	FF90754-185	-
<b>EC415-10</b>	HK1813	-	A1910	A2909	A4903	A3903	A6922	A9903	FF90754-209	-
<b>EC415-12</b>	HK2017	FF90311-300	A1912	A2910	A4904	A3904	A6924	A9903	FF90754-219	-
<b>EC415-16</b>	HK2317	FF90311-381	A1913	A2913	A4904	A3904	A6928	A9903	FF90754-288	-
<b>EC415-20</b>	HK3117	FF90311-445	A1916	A2917	A4906	A3906	A6936	A9904	FF90754-366	-
<b>EC415-24</b>	HK3317	FF90311-508	A1917	A2917	A4907	A3907	A6938	A9904	-	-
<b>EC415-32</b>	HK3817	FF90311-635	-	-	-	-	A6946	A9905	-	-
<b>EC420-12</b>	HK2117	FF90311-300	A1912	A2911	A4904	A3904	A6924	A9903	FF90754-219	-
<b>EC420-16</b>	HK2517	FF90311-381	A1913	A2913	A4904	A3904	A6930	A9903	FF90754-288	-
<b>EC420-20</b>	HK3217	FF90311-483	A1917	A2917	A4907	A3907	A6936	A9904	FF90754-366	-
<b>EC420-24</b>	HK3417	FF90311-572	A1919	A2919	A4907	A3907	A6940	A9904	-	-
<b>EC420-32</b>	HK3817	FF90311-700	-	-	-	-	A6950	A9905	-	-
<b>EC-4TW</b>	HK0709	-	A1901	A2900	A4900	A3900	A6908	A9900	FF90754-68	A5953
<b>EC-5TW</b>	HK0809	-	A1901	A2900	A4900	A3900	A6908	A9900	FF90754-68	A5953
<b>EC-6TW</b>	HK0913	-	A1901	A2901	A4900	A3900	A6908	A9900	FF90754-68	A5953
<b>EC-7TW</b>	HK0913	FF90311-127	A1901	A2901	A4900	A3900	A6912	A9901	FF90754-106	A5962
<b>EC-8TW</b>	HK1113	FF90311-137	A1902	A2902	A4900	A3900	A6910	A9901	FF90754-79	A5962
<b>EC-10TW</b>	HK1213	FF90311-160	A1904	A2904	A4900	A3900	A6912	A9902	FF90754-91	A5969
<b>EC-12TW</b>	HK1413	FF90311-190	A1905	A2905	A4900	A3900	A6914	A9902	FF90754-122	A5984
<b>EC-14TW</b>	HK1513	FF90311-222	A1907	A2907	A4902	A3902	A6920	A9902	FF90754-185	-
<b>EC-16TW</b>	HK1913	FF90311-254	A1912	A2909	A4902	A3902	A6920	A9903	FF90754-157	-
<b>EC-18TW</b>	HK1913	FF90311-280	A1910	A2910	A4904	A3904	A6924	A9903	FF90754-219	-
<b>EN-4TW</b>	HK0709	-	A1901	A2900	A4900	A3900	A6908	A9900	FF90754-68	A5953
<b>EN-5TW</b>	HK0809	-	A1901	A2900	A4900	A3900	A6908	A9900	FF90754-68	A5953
<b>EN-6TW</b>	HK0913	-	A1901	A2901	A4900	A3900	A6908	A9900	FF90754-68	A5953
<b>EN-7TW</b>	HK0913	FF90311-127	A1901	A2901	A4900	A3900	A6912	A9901	FF90754-106	A5962
<b>EN-8TW</b>	HK1113	FF90311-137	A1902	A2902	A4900	A3900	A6910	A9901	FF90754-79	A5962
<b>EN-10TW</b>	HK1213	FF90311-160	A1904	A2904	A4900	A3900	A6912	A9902	FF90754-91	A5969
<b>EN-12TW</b>	HK1413	FF90311-190	A1905	A2905	A4900	A3900	A6914	A9902	FF90754-122	A5984
<b>EN-14TW</b>	HK1513	FF90311-222	A1907	A2907	A4902	A3902	A6920	A9902	FF90754-185	-
<b>EN-16TW</b>	HK1913	FF90311-254	A1912	A2909	A4902	A3902	A6920	A9903	FF90754-157	-

Match accessories to hose										
Hose Part #	Hose clamp	Heavy duty hose clamp	Round-wire spring guard	Flat-wire spring guard	Nylon (.045) abrasion sleeve	Nylon (.090) abrasion sleeve	Silicone fiberglass Firesleeve	Poly hose guard	Guardian sleeve*	Bend restrictor
										
<b>EN-18TW</b>	HK1913	FF90311-280	A1910	A2910	A4904	A3904	A6924	A9903	FF90754-219	-
<b>FC800-12</b>	HK1913	FF90311-266	A1912	A2909	A4902	A3902	A6920	A9903	FF90754-157	-
<b>FC800-16</b>	HK2517	FF90311-300	A1913	A2913	A4904	A3904	A6924	A9903	FF90754-209	-
<b>FC800-20</b>	HK2617	FF90311-381	A1913	A2913	A4904	A3904	A6928	A9903	FF90754-238	-
<b>FC800-24</b>	HK3117	FF90311-445	A1916	A2917	A4906	A3906	A6932	A9904	FF90754-288	-
<b>GH001-4</b>	HK0913	-	A1901	A2900	A4900	A3900	A6908	A9900	FF90754-68	A5953
<b>GH001-6</b>	HK1113	FF90311-137	A1902	A2902	A4900	A3900	A6910	A9901	FF90754-79	A5962
<b>GH001-8</b>	HK1313	FF90311-174	A1904	A2904	A4900	A3900	A6912	A9902	FF90754-98	A5975
<b>GH001-10</b>	HK1413	FF90311-190	A1905	A2905	A4900	A3900	A6914	A9902	FF90754-122	A5984
<b>GH001-12</b>	HK1713	FF90311-239	A1908	A2908	A4901	A3901	A6920	A9903	FF90754-142	-
<b>GH001-16</b>	HK2117	FF90311-300	A1912	A2911	A4903	A3903	A6924	A9903	FF90754-185	-
<b>H03912</b>	HK2317	FF90311-280	A1912	A2911	A4903	A3903	A6924	A9903	FF90754-185	-
<b>H03916</b>	HK2617	FF90311-357	A1913	A2913	A4904	A3904	A6928	A9903	FF90754-219	-
<b>H03920</b>	HK3117	FF90311-445	A1916	A2917	A4906	A3906	A6932	A9904	FF90754-288	-
<b>H03924</b>	HK3417	FF90311-508	A1917	A2917	A4906	A3906	A6936	A9904	FF90754-366	-
<b>H03932</b>	HK3817	FF90311-635	-	-	A4907	A3907	A6948	A9905	-	-
<b>H05703</b>	HK0809	-	A1901	A2900	A4900	A3900	A6908	A9900	FF90754-68	A5953
<b>H05704</b>	HK1013	FF90311-127	A1901	A2901	A4900	A3900	A6910	A9901	FF90754-79	A5953
<b>H05705</b>	HK1113	FF90311-137	A1902	A2902	A4900	A3900	A6910	A9901	FF90754-79	A5962
<b>H05706</b>	HK1213	FF90311-150	A1903	A2904	A4900	A3900	A6912	A9901	FF90754-91	A5969
<b>H05904</b>	HK1013	FF90311-137	A1901	A2901	A4900	A3900	A6910	A9901	FF90754-79	A5962
<b>H05905</b>	HK1113	FF90311-150	A1902	A2902	A4900	A3900	A6910	A9901	FF90754-79	A5962
<b>H05906</b>	HK1313	FF90311-174	A1904	A2904	A4901	A3901	A6912	A9902	FF90754-98	A5975
<b>H05908</b>	HK1413	FF90311-190	A1905	A2905	A4901	A3901	A6914	A9902	FF90754-106	A5984
<b>H05910</b>	HK1713	FF90311-239	A1907	A2907	A4901	A3901	A6916	A9902	FF90754-142	-
<b>H05912</b>	HK1913	FF90311-266	A1910	A2909	A4902	A3902	A6920	A9903	FF90754-173	-
<b>H05916</b>	HK2317	FF90311-320	A1912	A2911	A4903	A3903	A6924	A9903	FF90754-185	-
<b>H10004</b>	HK1013	-	A1901	A2901	A4900	A3900	A6910	A9901	FF90754-79	A5953
<b>H10005</b>	HK1013	FF90311-137	A1902	A2901	A4900	A3900	A6910	A9901	FF90754-79	A5962
<b>H10006</b>	HK1213	FF90311-150	A1903	A2904	A4900	A3900	A6912	A9901	FF90754-91	A5969
<b>H10008</b>	HK1413	FF90311-174	A1905	A2905	A4900	A3900	A6914	A9902	FF90754-106	A5984
<b>H10010</b>	HK1713	FF90311-222	A1907	A2907	A4901	A3901	A6916	A9902	FF90754-142	-
<b>H10012</b>	HK1813	FF90311-254	A1912	A2909	A4902	A3902	A6920	A9903	FF90754-157	-
<b>H010504</b>	HK1113	FF90311-150	A1903	A2904	A4900	A3900	A6910	A9901	FF90754-91	A5969
<b>H010506</b>	HK1313	FF90311-174	A1904	A2904	A4900	A3900	A6912	A9902	FF90754-98	A5975
<b>H010508</b>	HK1513	FF90311-205	A1906	A2906	A4900	A3900	A6914	A9902	FF90754-122	-
<b>H010510</b>	HK1813	FF90311-239	A1908	A2908	A4901	A3901	A6920	A9902	FF90754-142	-
<b>H010512</b>	HK2017	FF90311-280	A1912	A2910	A4902	A3902	A6920	A9903	FF90754-173	-
<b>H010516</b>	HK2517	FF90311-334	A1913	A2912	A4904	A3904	A6924	A9903	FF90754-209	-
<b>H010520</b>	HK3117	FF90311-422	A1916	A2917	A4905	A3905	A6932	A9904	FF90754-288	-
<b>H010524</b>	HK3417	FF90311-508	A1917	A2917	A4906	A3906	A6936	A9904	FF90754-366	-











Accessories to hose chart

Match accessories to hose										
Hose Part #	Hose clamp	Heavy duty hose clamp	Round-wire spring guard	Flat-wire spring guard	Nylon (.045) abrasion sleeve	Nylon (.090) abrasion sleeve	Silicone fiberglass Firesleeve	Poly hose guard	Guardian sleeve*	Bend restrictor
										
H14504	HK1013	FF90311-127	A1901	A2901	A4900	A3900	A6910	A9901	FF90754-68	A5953
H14506	HK1213	FF90311-160	A1903	A2904	A4900	A3900	A6912	A9901	FF90754-91	A5969
H14508	HK1413	FF90311-205	A1905	A2905	A4900	A3900	A6914	A9902	FF90754-122	A5987
H14510	HK1713	FF90311-239	A1907	A2908	A4901	A3901	A6916	A9902	FF90754-142	-
H14512	HK2017	FF90311-280	A1912	A2910	A4902	A3902	A6920	A9903	FF90754-173	-
H14516	HK2517	FF90311-357	A1913	A2913	A4904	A3904	A6924	A9903	FF90754-209	-
H145R04	HK1013	FF90311-127	A1901	A2901	A4900	A3900	A6910	A9901	FF90754-68	A5953
H145R06	HK1213	FF90311-160	A1904	A2904	A4900	A3900	A6912	A9901	FF90754-91	A5969
H145R08	HK1413	FF90311-205	A1905	A2905	A4900	A3900	A6914	A9902	FF90754-122	A5987
H145R10	HK1713	FF90311-239	A1908	A2908	A4901	A4901	A6916	A9902	FF90754-142	-
H145R12	HK2017	FF90311-280	A1912	A2910	A4902	A3902	A6920	A9903	FF90754-173	-
H145R16	HK2517	FF90311-334	A1913	A2913	A4904	A3904	A6924	A9903	FF90754-209	-
H16604	HK1013	FF90311-127	A1902	A2901	A4900	A3900	A6910	A9901	FF90754-79	A5962
H16605	HK1113	FF90311-137	A1902	A2902	A4900	A3900	A6910	A9901	FF90754-79	A5962
H16606	HK1313	FF90311-171	A1904	A2904	A4900	A3900	A6912	A9902	FF90754-98	A5975
H16608	HK1413	FF90311-190	A1905	A2905	A4900	A3900	A6914	A9902	FF90754-106	A5984
H16610	HK1713	FF90311-222	A1907	A2907	A4901	A3901	A6916	A9902	FF90754-142	-
H16612	HK1913	FF90311-266	A1910	A2910	A4902	A3902	A6920	A9903	FF90754-157	-
H16616	HK2317	FF90311-300	A1912	A2911	A4903	A3903	A6924	A9903	FF90754-185	-
H16620	HK2617	FF90311-357	A1913	A2913	A4904	A3904	A6928	A9903	FF90754-219	-
H16906	HK1313	FF90311-171	A1904	A2904	A4900	A3900	A6912	A9902	FF90754-91	A5975
H16908	HK1413	FF90311-174	A1905	A2905	A4900	A3900	A6914	A9902	FF90754-106	A5984
H16910	HK1713	FF90311-222	A1907	A2907	A4901	A3901	A6916	A9902	FF90754-142	-
H16912	HK1913	FF90311-266	A1912	A2910	A4902	A3902	A6920	A9903	FF90754-157	-
H16916	HK2317	FF90311-300	A1912	A2911	A4903	A3903	A6924	A9903	FF90754-185	-
H16920	HK2617	FF90311-357	A1913	A2913	A4904	A3904	A6928	A9903	FF90754-219	-
H16924	HK3117	FF90311-422	A1916	A2917	A4905	A3905	A6932	A9904	FF90754-288	-
H16932	HK3817	FF90311-508	A1919	A2919	A4907	A3907	A6948	A9904	FF90754-366	-
H18004	HK1013	FF90311-127	A1901	A2901	A4900	A3900	A6910	A9901	FF90754-79	A5962
H18006	HK1213	FF90311-160	A1903	A2904	A4900	A3900	A6912	A9901	FF90754-91	A5969
H18008	HK1413	FF90311-190	A1905	A2905	A4900	A3900	A6914	A9902	FF90754-106	A5984
H18010	HK1613	FF90311-222	A1906	A2907	A4901	A3901	A6916	A9902	FF90754-122	-
H18012	HK1813	FF90311-254	A1908	A2908	A4901	A3901	A6920	A9903	FF90754-157	-
H18016	HK2317	FF90311-334	A1913	A2912	A4904	A3904	A6924	A9903	FF90754-209	-
H18020	HK2917	FF90311-400	A1913	A2917	A4905	A3905	A6928	A9904	FF90754-238	-
H18024	HK3217	FF90311-445	A1917	A2917	A4906	A3906	A6932	A9904	FF90754-288	-
H18032	HK3817	FF90311-635	-	-	A4907	A3907	A6948	A9905	-	-
H19004	HK1013	FF90311-127	A1902	A2901	A4900	A3900	A6910	A9901	FF90754-79	A5962
H19006	HK1313	FF90311-171	A1904	A2904	A4900	A3900	A6912	A9902	FF90754-91	A5975
H19008	HK1413	FF90311-190	A1905	A2905	A4900	A3900	A6914	A9902	FF90754-122	A5984
H19010	HK1713	FF90311-222	A1907	A2907	A4901	A3901	A6916	A9902	FF90754-142	-

Match accessories to hose										
Hose clamp	Heavy duty hose clamp	Round-wire spring guard	Flat-wire spring guard	Nylon (.045) abrasion sleeve	Nylon (.090) abrasion sleeve	Silicone fiberglass Firesleeve	Poly hose guard	Guardian sleeve*	Bend restrictor	
Hose Part #										
H19012	HK1913	FF90311-266	A1912	A2909	A4902	A3902	A6920	A9903	FF90754-157	-
H19016	HK2517	FF90311-334	A1913	A2913	A4904	A3904	A6924	A9903	FF90754-209	-
H19020	HK2917	FF90311-422	A1916	A2917	A4905	A3905	A6928	A9904	FF90754-288	-
H19024	HK3317	FF90311-483	A1917	A2917	A4906	A3906	A6932	A9904	FF90754-288	-
H19032	HK3817	FF90311-635	-	-	A4907	A3907	A6948	A9905	-	-
H190H04	HK1013	FF90311-127	A1902	A2901	A4900	A3900	A6910	A9901	FF90754-79	A5962
H190H06	HK1313	FF90311-171	A1904	A2904	A4900	A3900	A6912	A9902	FF90754-91	A5975
H190H08	HK1413	FF90311-190	A1905	A2905	A4900	A3900	A6914	A9902	FF90754-122	A5984
H190H10	HK1713	FF90311-222	A1907	A2907	A4901	A3901	A6916	A9902	FF90754-142	-
H190H12	HK1913	FF90311-266	A1912	A2909	A4902	A3902	A6920	A9903	FF90754-157	-
H190H16	HK2517	FF90311-357	A1913	A2913	A4904	A3904	A6924	A9903	FF90754-209	-
H190H20	HK2917	FF90311-422	A1916	A2917	A4905	A3905	A6928	A9904	FF90754-288	-
H190H24	HK3417	FF90311-483	A1917	A2917	A4906	A3906	A6936	A9904	FF90754-288	-
H190H32	HK3817	FF90311-572	-	-	A4907	A3907	A6948	A9905	-	-
H20104	HK1013	FF90311-127	A1901	A2901	A4900	A3900	A6910	A9901	FF90754-79	A5953
H20105	HK1113	FF90311-137	A1902	A2902	A4900	A3900	A6910	A9901	FF90754-79	A5962
H20106	HK1313	FF90311-160	A1904	A2904	A4900	A3900	A6912	A9902	FF90754-91	A5975
H20108	HK1413	FF90311-190	A1905	A2905	A4900	A3900	A6914	A9902	FF90754-106	A5984
H20110	HK1713	FF90311-222	A1907	A2907	A4901	A3901	A6916	A9902	FF90754-142	-
H20112	HK1913	FF90311-254	A1912	A2909	A4902	A3902	A6920	A9903	FF90754-157	-
H20116	HK2517	FF90311-334	A1913	A2913	A4904	A3904	A6924	A9903	FF90754-209	-
H20904	HK0913	-	A1901	A2900	A4900	A3900	A6908	A9900	FF90754-68	A5953
H20906	HK1013	FF90311-137	A1902	A2901	A4900	A3900	A6910	A9901	FF90754-79	A5962
H20908	HK1313	FF90311-174	A1904	A2904	A4900	A3900	A6912	A9902	FF90754-98	A5975
H21304	HK1013	-	A1901	A2901	A4900	A3900	A6910	A9901	FF90754-68	A5953
H21305	HK1113	FF90311-137	A1902	A2902	A4900	A3900	A6910	A9901	FF90754-79	A5962
H21306	HK1213	FF90311-150	A1903	A2904	A4900	A3900	A6912	A9901	FF90754-91	A5969
H21308	HK1413	FF90311-174	A1905	A2905	A4900	A3900	A6914	A9902	FF90754-98	A5984
H21310	HK1513	FF90311-205	A1906	A2905	A4900	A3900	A6914	A9902	FF90754-122	A5987
H21312	HK1713	FF90311-239	A1907	A2907	A4901	A3901	A6916	A9902	FF90754-142	-
H21316	HK2117	FF90311-300	A1912	A2911	A4903	A3903	A6920	A9903	FF90754-173	-
H22904	HK1013	FF90311-127	A1902	A2901	A4900	A3900	A6910	A9901	FF90754-79	A5962
H22906	HK1413	FF90311-171	A1905	A2905	A4900	A3900	A6914	A9902	FF90754-98	A5975
H22908	HK1613	FF90311-190	A1907	A2907	A4901	A3901	A6916	A9902	FF90754-122	A5984
H22910	HK1813	FF90311-222	A1908	A2908	A4901	A3901	A6920	A9903	FF90754-142	-
H22912	HK2317	FF90311-266	A1912	A2911	A4903	A3903	A6924	A9903	FF90754-185	-
H23904	HK1013	FF90311-127	A1902	A2901	A4900	A3900	A6910	A9901	FF90754-79	A5962
H23906	HK1313	FF90311-171	A1904	A2904	A4900	A3900	A6912	A9902	FF90754-98	A5975
H23908	HK1413	FF90311-190	A1905	A2905	A4900	A3900	A6914	A9902	FF90754-122	A5984
H23910	HK1713	FF90311-222	A1907	A2907	A4901	A3901	A6916	A9902	FF90754-142	-
H23912	HK1813	FF90311-266	A1908	A2908	A4901	A3901	A6920	A9903	FF90754-142	-











Accessories to hose chart

Match accessories to hose										
Hose Part #	Hose clamp	Heavy duty hose clamp	Round-wire spring guard	Flat-wire spring guard	Nylon (.045) abrasion sleeve	Nylon (.090) abrasion sleeve	Silicone fiberglass Firesleeve	Poly hose guard	Guardian sleeve*	Bend restrictor
H23916	HK2317	FF90311-300	A1912	A2911	A4903	A3903	A6924	A9903	FF90754-185	-
H23920	HK2617	FF90311-357	A1913	A2913	A4904	A3904	A6928	A9903	FF90754-219	-
H245L04	HK1013	FF90311-137	A1902	A2901	A4900	A3900	A6910	A9901	FF90754-79	A5962
H245L06	HK1213	FF90311-174	A1904	A2904	A4900	A3900	A6912	A9902	FF90754-91	A5975
H245L08	HK1513	FF90311-205	A1906	A2905	A4900	A3900	A6914	A9902	FF90754-122	A5987
H245L10	HK1713	FF90311-239	A1908	A2908	A4901	A3901	A6916	A9902	FF90754-142	-
H245L12	HK1913	FF90311-280	A1912	A2910	A4902	A3902	A6920	A9903	FF90754-157	-
H245L16	HK2517	FF90311-357	A1912	A2913	A4904	A3904	A6924	A9903	FF90754-209	-
H245L20	HK2917	FF90311-422	A1916	A2917	A4905	A3905	A2928	A9904	FF90754-288	-
H245L24	HK3417	FF90311-508	A1917	A2917	A4906	A3906	A6936	A9904	FF90754-366	-
H245L32	HK3817	FF90311-635	-	-	A4907	A3907	A6948	A9905	-	-
H250H04	HK0809	-	A1901	A2900	A4900	A3900	A6911	A9900	FF90754-98	A5953
H250H06	HK1013	FF90311-137	A1902	A2902	A4900	A3900	A6913	A9901	FF90754-142	A5962
H250H08	HK1113	FF90311-160	A1904	A2904	A4901	A3901	A6916	A9902	FF90754-142	A5975
H250H10	HK1313	FF90311-190	A1905	A2905	A4902	A3902	A6918	A9902	FF90754-157	A5984
H250H12	HK1513	FF90311-222	A1906	A2907	A4902	A3902	A6920	A9902	FF90754-185	-
H250H16	HK1913	FF90311-280	A1910	A2910	A4904	A3904	A6924	A9903	FF90754-219	-
H27504	HK0913	-	A1901	A2900	A4900	A3900	A6908	A9900	FF90754-68	A5953
H27506	HK1213	FF90311-150	A1903	A2904	A4900	A3900	A6912	A9901	FF90754-91	A5969
H27508	HK1413	FF90311-190	A1905	A2905	A4900	A3900	A6914	A9902	FF90754-106	A5984
H27510	HK1613	FF90311-222	A1907	A2907	A4901	A3901	A6916	A9902	FF90754-122	-
H27512	HK1813	FF90311-254	A1912	A2909	A4901	A3901	A6920	A9903	FF90754-157	-
H27516	HK2317	FF90311-320	A1912	A2912	A4903	A3903	A6924	A9903	FF90754-185	-
H27520	HK2917	FF90311-422	A1916	A2917	A4905	A3905	A6928	A9904	FF90754-288	-
H27524	HK3317	FF90311-483	A1917	A2917	A4906	A3906	A6932	A9904	FF90754-288	-
H27532	HK3817	FF90311-572	-	-	A4907	A3907	A6948	A9905	-	-
H28004	HK1013	FF90311-137	A1902	A2901	A4900	A3900	A6910	A9901	FF90754-79	A5962
H28006	HK1313	FF90311-171	A1904	A2904	A4900	A3900	A6912	A9902	FF90754-91	A5975
H28008	HK1513	FF90311-205	A1905	A2905	A4900	A3900	A6914	A9902	FF90754-122	A5987
H28010	HK1713	FF90311-222	A1907	A2907	A4901	A3901	A6916	A9902	FF90754-142	-
H28012	HK1913	FF90311-266	A1912	A2910	A4902	A3902	A6920	A9903	FF90754-157	-
H28016	HK2517	FF90311-334	A1913	A2913	A4904	A3904	A6924	A9903	FF90754-209	-
H28020	HK2917	FF90311-422	A1916	A2917	A4905	A3905	A6928	A9904	FF90754-288	-
H28024	HK3417	FF90311-508	A1917	A2917	A4906	A3906	A6936	A9904	FF90754-366	-
H28032	HK3817	FF90311-635	-	-	A4907	A3907	A6948	A9905	-	-
H28503	HK0709	-	A1901	A2900	A4900	A3900	A6908	A9900	FF90754-68	A5953
H28504	HK0913	-	A1901	A2900	A4900	A3900	A6908	A9900	FF90754-68	A5953
H28505	HK1013	FF90311-127	A1902	A2901	A4900	A3900	A6910	A9901	FF90754-79	A5962
H28506	HK1113	FF90311-137	A1902	A2902	A4900	A3900	A6910	A9901	FF90754-79	A5962
H28508	HK1413	FF90311-174	A1905	A2905	A4900	A3900	A6914	A9902	FF90754-98	A5984
H28510	HK1513	FF90311-205	A1906	A2905	A4900	A3900	A6914	A9902	FF90754-122	-











Match accessories to hose										
Hose clamp	Heavy duty hose clamp	Round-wire spring guard	Flat-wire spring guard	Nylon (.045) abrasion sleeve	Nylon (.090) abrasion sleeve	Silicone fiberglass Firesleeve	Poly hose guard	Guardian sleeve*	Bend restrictor	
Hose Part #										
H28512	HK1813	FF90311-239	A1908	A2908	A4901	A3901	A6920	A9903	FF90754-157	-
H28516	HK2317	FF90311-320	A1912	A2912	A4903	A3903	A6924	A9903	FF90754-185	-
H28520	HK2917	FF90311-400	A1916	A2917	A4905	A3905	A6928	A9904	FF90754-238	-
H28524	HK3317	FF90311-445	A1917	A2917	A4906	A3906	A6932	A9904	FF90754-288	-
H28532	HK3817	FF90311-572	-	-	A4907	A3907	A6948	A9905	-	-
H29004	HK1113	FF90311-137	A1902	A2902	A4900	A3900	A6910	A9901	FF90754-79	A5962
H29006	HK1413	FF90311-174	A1905	A2905	A4900	A3900	A6914	A9902	FF90754-98	A5984
H29008	HK1613	FF90311-205	A1906	A2906	A4900	A3900	A6916	A9902	FF90754-122	-
H29010	HK1813	FF90311-254	A1908	A2908	A4901	A3901	A6920	A9902	FF90754-142	-
H29012	HK2017	FF90311-280	A1912	A2910	A4902	A3902	A6920	A9903	FF90754-173	-
H29016	HK2617	FF90311-357	A1913	A2913	A4904	A3904	A6928	A9903	FF90754-219	-
H29020	HK3217	FF90311-445	A1917	A2917	A4906	A3906	A6932	A9904	FF90754-288	-
H29024	HK3817	FF90311-508	A1919	A2919	A4906	A3906	A6936	A9904	FF90754-366	-
H29032	HK3817	FF90311-635	-	-	A4907	A3907	A6948	A9905	-	-
H290H04	HK1113	FF90311-137	A1902	A2902	A4900	A3900	A6912	A9901	FF90754-79	A5962
H290H06	HK1413	FF90311-174	A1905	A2905	A4900	A3900	A6914	A9902	FF90754-98	A5984
H290H08	HK1513	FF90311-205	A1906	A2905	A4900	A3900	A6924	A9902	FF90754-122	-
H290H10	HK1713	FF90311-239	A1908	A2908	A4901	A3901	A6916	A9902	FF90754-142	-
H290H12	HK2017	FF90311-280	A1912	A2910	A4902	A3902	A6920	A9903	FF90754-173	-
H290H16	HK2517	FF90311-357	A1913	A2913	A4904	A3904	A6924	A9903	FF90754-209	-
H290H20	HK3217	FF90311-483	A1917	A2917	A4906	A3906	A6932	A9904	FF90754-288	-
H290H24	HK3817	FF90311-508	A1919	A2919	A4906	A3906	A6936	A9904	FF90754-366	-
H290H32	-	FF90311-635	-	-	A4908	A3908	A6948	A9905	-	-
H33204	HK1013	-	A1901	A2901	A4900	A3900	A6910	A9901	FF90754-79	A5953
H33206	HK1213	FF90311-150	A1903	A2904	A4900	A3900	A6912	A9901	FF90754-91	A5969
H33208	HK1413	FF90311-174	A1905	A2905	A4900	A3900	A6914	A9902	FF90754-106	A5984
H33210	HK1713	FF90311-222	A1907	A2907	A4901	A3901	A6916	A9902	FF90754-142	-
H33212	HK1913	FF90311-254	A1912	A2910	A4902	A3902	A6920	A9903	FF90754-157	-
H34504	HK0809	-	A1901	A2900	A4900	A3900	A6912	A9902	FF90754-106	A5953
H34506	HK1113	FF90311-150	A1903	A2904	A4900	A3900	A6914	A9904	FF90754-142	A5969
H34508	HK1313	FF90311-190	A1905	A2905	A4902	A3902	A6918	A9904	FF90754-173	A5984
H353H04	HK0913	FF90311-127	A1901	A2901	A4900	A3900	A6913	A9901	FF90754-106	A5962
H353H05	HK1013	FF90311-137	A1902	A2902	A4900	A3900	A6914	A9901	FF90754-142	A5962
H353H06	HK1113	FF90311-171	A1904	A2904	A4901	A3901	A6916	A9902	FF90754-142	A5975
H353H08	HK1313	FF90311-190	A1905	A2905	A4902	A3902	A6918	A9902	FF90754-157	A5984
H353H10	HK1513	FF90311-222	A1907	A2907	A4902	A3902	A6920	A9902	FF90754-185	-
H353H12	HK1813	FF90311-266	A1910	A2909	A4903	A3903	A6922	A9903	FF90754-209	-
H353H16	HK2017	FF90311-300	A1912	A2911	A4904	A3904	A6924	A9903	FF90754-219	-
H353H20	HK2317	FF90311-357	A1913	A2913	A4904	A3904	A6928	A9903	FF90754-288	-
H353H24	HK2917	FF90311-445	A1916	A2917	A4906	A3906	A6936	A9904	FF90754-366	-
H40010	HK1013	FF90311-254	A1908	A2908	A4901	A3901	A6920	A9903	FF90754-142	-
H40012	HK1313	FF90311-280	A1912	A2910	A4902	A3902	A6920	A9903	FF90754-173	-
H42104	HK1013	FF90311-137	A1902	A2901	A4900	A3900	A6910	A9901	FF90754-79	A5962
H42106	HK1413	FF90311-190	A1905	A2905	A4900	A3900	A6914	A9902	FF90754-91	A5984
H43006	HK1413	FF90311-190	A1905	A2905	A4900	A3900	A6914	A9902	FF90754-122	A5984













Accessories to hose chart











Match accessories to hose										
Hose clamp	Heavy duty hose clamp	Round-wire spring guard	Flat-wire spring guard	Nylon (.045) abrasion sleeve	Nylon (.090) abrasion sleeve	Silicone fiberglass Firesleeve	Poly hose guard	Guardian sleeve*	Bend restrictor	
Hose Part #										
H43008	HK1613	FF90311-222	A1907	A2907	A4901	A3901	A6916	A9902	FF90754-142	-
H43010	HK1913	FF90311-266	A1912	A2909	A4902	A3902	A6920	A9903	FF90754-157	-
H43012	HK2117	FF90311-300	A1912	A2910	A4902	A3902	A6920	A9903	FF90754-173	-
H43016	HK2517	FF90311-357	A1913	A2913	A4904	A3904	A6924	A9903	FF90754-219	-
H43020	HK3117	FF90311-445	A1916	A2917	A4906	A3906	A6932	A9904	FF90754-288	-
H43024	HK3417	FF90311-508	A1917	A2917	A4906	A3906	A6936	A9904	FF90754-366	-
H43032	-	FF90311-635	-	-	A4908	A3908	A6948	A9905	-	-
H430R06	HK1413	FF90311-190	A1905	A2905	A4900	A3900	A6914	A9902	FF90754-122	A5984
H430R08	HK1613	FF90311-222	A1907	A2907	A4901	A3901	A6916	A9902	FF90754-142	-
H430R10	HK1913	FF90311-266	A1912	A2909	A4902	A3902	A6920	A9903	FF90754-157	-
H430R12	HK2117	FF90311-300	A1912	A2910	A4902	A3902	A6920	A9903	FF90754-173	-
H430R16	HK2617	FF90311-357	A1913	A2913	A4904	A3904	A6928	A9903	FF90754-219	-
H430R20	HK3117	FF90311-445	A1916	A2917	A4906	A3906	A6932	A9904	FF90754-288	-
H430R24	HK3417	FF90311-508	A1917	A2917	A4906	A3906	A6936	A9904	FF90754-366	-
H430R32	-	FF90311-635	-	-	A4908	A3908	A6948	A9905	-	-
H46412	HK2317	FF90311-320	A1912	A2911	A4903	A3903	A6924	A9903	FF90754-185	-
H46416	HK2617	FF90311-381	A1913	A2913	A4904	A3904	A6928	A9903	FF90754-219	-
H46420	HK3117	FF90311-357	A1916	A2917	A4905	A3905	A6932	A9904	FF90754-288	-
H46424	HK3417	FF90311-508	A1917	A2917	A4906	A3906	A6936	A9904	FF90754-366	-
H46432	-	FF90311-635	-	-	A4908	A3908	A6948	A9905	-	-
H47112	HK2117	FF90311-300	A1912	A2911	A4903	A3903	A6924	A9903	FF90754-173	-
H47116	HK2617	FF90311-381	A1913	A2913	A4904	A3904	A6928	A9903	FF90754-219	-
H47120	HK3117	FF90311-445	A1916	A2917	A4906	A3906	A6932	A9904	FF90754-288	-
H47124	HK3817	FF90311-508	A1919	A2919	A4906	A3906	A6936	A9904	FF90754-366	-
H47132	-	FF90311-700	-	-	-	-	A6948	A9905	-	-
H504	HK0809	-	A1900	A2900	A4900	A3900	A6908	A9900	FF90754-68	A5953
H506	HK1013	FF90311-127	A1900	A2901	A4900	A3900	A6910	A9901	FF90754-79	A5962
H508	HK1213	FF90311-150	A1903	A2904	A4900	A3900	A6912	A9901	FF90754-91	A5969
H510	HK1413	FF90311-190	A1905	A2905	A4900	A3900	A6914	A9902	FF90754-106	A5984
H512	HK1713	FF90311-239	A1908	A2908	A4901	A3901	A6916	A9902	FF90754-142	-
H516	HK2317	FF90311-334	A1912	A2912	A4903	A3903	A6924	A9903	FF90754-185	-
H520	HK2917	FF90311-400	A1913	A2913	A4904	A3904	A6928	A9904	FF90754-238	-
H524	HK3117	FF90311-445	A1916	A6917	A4906	A3906	A6932	A9904	FF90754-288	-
H525H12	HK2017	FF90311-300	A1912	A2910	A4904	A3904	A6924	A9903	FF90754-219	-
H525H16	HK2317	FF90311-357	A1913	A2913	A4904	A3904	A6928	A9903	FF90754-288	-
H525H20	HK3117	FF90311-445	A1916	A2917	A4906	A3906	A6936	A9904	FF90754-366	-
H525H24	HK3317	FF90311-508	A1917	A2917	A4907	A3907	A6938	A9904	-	-
H525H32	HK3817	FF90311-635	-	-	-	-	A6948	A9905	-	-
H54504	HK1013	FF90311-127	A1901	A2901	A4900	A3900	A6910	A9901	FF90754-79	-
H54506	HK1213	FF90311-150	A1903	A2904	A4900	A3900	A6912	A9901	FF90754-91	-
H54508	HK1513	FF90311-190	A1905	A2905	A4900	A3900	A6914	A9902	FF90754-122	-
H54510	HK1713	FF90311-239	A1907	A2907	A4901	A3901	A6916	A9902	FF90754-142	-
H54512	HK2017	FF90311-280	A1912	A2910	A4902	A3902	A6920	A9903	FF90754-173	-
H54516	HK2517	FF90311-357	A1913	A2913	A4904	A3904	A6924	A9903	FF90754-209	-
H56904	HK1013	FF90311-127	A1902	A2901	A4900	A3900	A6910	A9901	FF90754-79	A5962
H56905	HK1113	FF90311-137	A1902	A2902	A4900	A3900	A6910	A9901	FF90754-79	A5962



Match accessories to hose										
Hose clamp	Heavy duty hose clamp	Round-wire spring guard	Flat-wire spring guard	Nylon (.045) abrasion sleeve	Nylon (.090) abrasion sleeve	Silicone fiberglass Firesleeve	Poly hose guard	Guardian sleeve*	Bend restrictor	
Hose Part #										
H56906	HK1313	FF90311-171	A1904	A2904	A4900	A3900	A6912	A9902	FF90754-98	A5975
H56908	HK1413	FF90311-190	A1905	A2905	A4900	A3900	A6914	A9902	FF90754-106	A5984
H56910	HK1713	FF90311-222	A1907	A2907	A4901	A3901	A6916	A9902	FF90754-142	-
H56912	HK1913	FF90311-266	A1912	A2910	A4902	A3902	A6920	A9903	FF90754-157	-
H56916	HK2317	FF90311-300	A1912	A2911	A4903	A3903	A6924	A9903	FF90754-185	-
H56920	HK2617	FF90311-357	A1913	A2913	A4904	A3904	A6928	A9903	FF90754-219	-
H60012	HK2117	FF90311-320	A1912	A2911	A4904	A3904	A6926	A9903	FF90754-238	-
H60016	HK2517	FF90311-381	A1913	A2913	A4904	A3904	A6930	A9903	FF90754-288	-
H60020	HK3217	FF90311-483	A1917	A2917	A4907	A3907	A6936	A9904	FF90754-366	-
H60024	HK3417	FF90311-572	A1919	A2919	A4907	A3907	A6940	A9904	-	-
H60032	HK3817	FF90311-700	-	-	-	-	A6950	A9905	-	-
H810L12	HK2117	FF90311-320	A1912	A2912	A4905	A3905	A6928	A9903	FF90754-142	-
H810L16	HK2517	FF90311-381	A1913	A2913	A4906	A3906	A6936	A9903	FF90754-157	-
H810L20	HK3317	FF90311-508	A1917	A2917	A4906	A3906	A6932	A9904	FF90754-209	-
H810L24	HK3817	FF90311-572	A1919	A2919	A4907	A3907	A6948	A9904	FF90754-238	-
H810L32	-	FF90311-700	-	-	A4908	A3908	A6948	A9905	FF90754-288	-
H85010	HK1813	FF90311-266	A1910	A2909	A4904	A3904	A6922	A9903	FF90754-209	-
H85012	HK2117	FF90311-300	A1912	A2911	A4904	A3904	A6926	A9903	FF90754-238	-
H85016	HK2517	FF90311-381	A1913	A2913	A4905	A3905	A6930	A9903	FF90754-288	-
H85020	HK3217	FF90311-483	A1917	A2917	A4906	A3906	A6936	A9904	FF90754-366	-
H88104	HK0913	FF90311-127	A1902	A2901	A4900	A3900	A6913	A9901	FF90754-122	A5962
H88105	HK1013	FF90311-150	A1903	A2902	A4900	A3900	A6914	A9901	FF90754-142	A5969
H88106	HK1113	FF90311-171	A1904	A2904	A4901	A3901	A6916	A9902	FF90754-142	A5975
H88108	HK1413	FF90311-205	A1905	A2905	A4902	A3902	A6918	A9902	FF90754-173	A5987
H88110	HK1613	FF90311-222	A1907	A2907	A4902	A3902	A6920	A9902	FF90754-185	-
H88112	HK1813	FF90311-266	A1910	A2909	A4904	A3904	A6922	A9903	FF90754-209	-
H88116	HK2317	FF90311-334	A1913	A2912	A4904	A3904	A6926	A9903	FF90754-288	-
H88120	HK2617	FF90311-422	A1916	A2917	A4906	A3906	A6932	A9904	FF90754-366	-
H88124	HK3317	FF90311-508	A1917	A2917	A4907	A3907	A6938	A9904	-	-
H88132	HK3417	FF90311-635	-	-	A4908	A3908	A6946	A9905	-	-
H010604	HK1013	-	A1902	A2901	A4900	A3900	A6910	A9901	FF90754-79	A5953
H010605	HK1213	FF90311-150	A1904	A2904	A4900	A3900	A6912	A9901	FF90754-91	A5969
H010606	HK1313	FF90311-171	A1905	A2904	A4900	A3900	A6912	A9902	FF90754-98	A5975
H010608	HK1513	FF90311-190	A1906	A2905	A4900	A3900	A6914	A9902	FF90754-122	A5984
H010610	HK1713	FF90311-222	A1908	A2907	A4901	A3901	A6916	A9902	FF90754-142	-
H010612	HK2017	FF90311-280	A1912	A2910	A4902	A3902	A6920	A9903	FF90754-173	-
H171910	HK1513	-	A1906	A2905	A4900	A3900	A6914	A9902	FF90754-122	-
H171912	HK1813	-	A1912	A2909	A4902	A3902	A6920	A9903	FF90754-157	-
H177604	HK1113	FF90311-137	A1903	A2902	A4900	A3900	A6910	A9901	FF90754-79	A5962
H177606	HK1313	FF90311-174	A1904	A2904	A4900	A3900	A6912	A9902	FF90754-98	A5975
H177608	HK1613	FF90311-205	A1906	A2906	A4901	A3901	A6916	A9902	FF90754-122	-
H177610	HK1713	FF90311-239	A1908	A2908	A4901	A3901	A6920	A9902	FF90754-142	-
H177612	HK2017	FF90311-280	A1912	A2910	A4902	A3902	A6920	A9903	FF90754-173	-
H177616	HK2517	FF90311-357	A1913	A2913	A4904	A3904	A6924	A9903	FF90754-209	-
H177620	HK2917	FF90311-422	A1916	A2917	A4905	A3905	A6932	A9904	FF90754-288	-
H177624	HK3317	FF90311-483	A1917	A2917	A4906	A3906	A6936	A9904	FF90754-366	-

Accessories to hose chart

Match accessories to hose										
Hose clamp	Heavy duty hose clamp	Round-wire spring guard	Flat-wire spring guard	Nylon (.045) abrasion sleeve	Nylon (.090) abrasion sleeve	Silicone fiberglass Firesleeve	Poly hose guard	Guardian sleeve*	Bend restrictor	
										
Hose Part #										
H177704	HK0913	FF90311-127	A1901	A2901	A4900	A3900	A6910	A9901	FF90754-68	A5962
H177705	HK1213	FF90311-150	A1903	A2904	A4900	A3900	A6912	A9901	FF90754-91	A5969
H177706	HK1213	FF90311-160	A1904	A2904	A4900	A3900	A6912	A9902	FF90754-91	A5969
H177708	HK1513	FF90311-190	A1905	A2905	A4900	A3900	A6914	A9902	FF90754-122	A5984
H181204	HK1113	FF90311-137	A1902	A2902	A4900	A3900	A6910	A9901	FF90754-79	A5962
H181206	HK1313	FF90311-174	A1904	A2904	A4900	A3900	A6912	A9902	FF90754-98	A5975
H181208	HK1613	FF90311-205	A1906	A2906	A4901	A3901	A6916	A9902	FF90754-122	-
H181210	HK1713	FF90311-239	A1908	A2908	A4901	A3901	A6920	A9902	FF90754-142	-
H181212	HK2017	FF90311-280	A1912	A2910	A4902	A3902	A6920	A9903	FF90754-173	-
H181216	HK2517	FF90311-357	A1913	A2913	A4904	A3904	A6924	A9903	FF90754-209	-
H181220	HK2917	FF90311-422	A1916	A2917	A4905	A3905	A6932	A9904	FF90754-288	-
H181224	HK3317	FF90311-483	A1917	A2917	A4906	A3906	A6936	A9904	FF90754-366	-
H198104	HK0913	-	A1901	A2901	A4900	A3900	A6910	A9901	FF90754-68	A5953
H198105	HK1213	FF90311-150	A1903	A2904	A4900	A3900	A6912	A9901	FF90754-91	A5969
H198106	HK1313	FF90311-174	A1904	A2904	A4900	A3900	A6912	A9902	FF90754-91	A5975
H198108	HK1413	FF90311-205	A1905	A2905	A4900	A3900	A6914	A9902	FF90754-122	-
H198112	HK2117	FF90311-280	A1912	A2910	A4902	A3902	A6920	A9903	FF90754-173	-
H198204	HK1213	FF90311-137	A1903	A2904	A4900	A3900	A6912	A9901	FF90754-91	A5962
H198205	HK1313	FF90311-171	A1904	A2904	A4900	A3900	A6912	A9902	FF90754-91	A5975
H198206	HK1313	FF90311-174	A1905	A2905	A4900	A3900	A6914	A99002	FF90754-98	A5975
H198208	HK1613	FF90311-205	A1906	A2906	A4901	A3901	A6916	A9902	FF90754-122	-
H198210	HK1813	FF90311-239	A1908	A2909	A4902	A3902	A6920	A9903	FF90754-157	-
H198212	HK1913	FF90311-280	A1912	A2909	A4902	A3902	A6920	A9903	FF90754-157	-
H198216	HK2517	FF90311-357	A1913	A2913	A4904	A3904	A6924	A9903	FF90754-209	-
H198710	HK1713	FF90311-239	A1907	A2907	A4901	A3901	A6916	A9902	FF90754-142	-
H198712	HK1913	FF90311-266	A1912	A2909	A4902	A3902	A6920	A9903	FF90754-157	-
H994904	HK1113	FF90311-137	A1902	A2902	A4900	A3900	A6910	A9901	FF90754-79	A5962
H994906	HK1313	FF90311-174	A1904	A2904	A4900	A3900	A6912	A9902	FF90754-98	A5975
H994908	HK1613	FF90311-205	A1906	A2906	A4901	A3901	A6916	A9902	FF90754-122	-
H994912	HK2017	FF90311-280	A1912	A2910	A4902	A3902	A6920	A9903	FF90754-173	-
H994916	HK2517	FF90311-357	A1913	A2913	A4904	A3904	A6924	A9903	FF90754-209	-
S-3	HK0709	-	A1901	A2900	A4900	A3900	A6908	A9900	FF90754-68	A5953
S-4	HK0709	-	A1901	A2900	A4900	A3900	A6908	A9900	FF90754-68	A5953
S-5	HK0809	-	A1901	A2900	A4900	A3900	A6908	A9900	FF90754-68	A5953
S-6	HK0913	-	A1901	A2901	A4900	A3900	A6908	A9900	FF90754-68	A5953
S-8	HK1113	FF90311-137	A1902	A2902	A4900	A3900	A6910	A9901	FF90754-79	A5962
S-10	HK1213	FF90311-171	A1904	A2904	A4900	A3900	A6912	A9902	FF90754-91	A5975
S-12	HK1413	FF90311-190	A1905	A2905	A4900	A3900	A6914	A9902	FF90754-122	A5984
S-16	HK1913	FF90311-266	A1912	A2909	A4902	A3902	A6920	A9903	FF90754-157	-
S-16Z	HK2017	FF90311-280	A1912	A2910	A4902	A3902	A6920	A9903	FF90754-173	-
S-20Z	HK2517	FF90311-334	A1913	A2913	A4904	A3904	A6924	A9903	FF90754-209	-
SC-3	HK0709	-	A1901	A2900	A4900	A3900	A6908	A9900	FF90754-68	A5953
SC-4	HK0709	-	A1901	A2900	A4900	A3900	A6908	A9900	FF90754-68	A5953
SC-5	HK0809	-	A1901	A2900	A4900	A3900	A6908	A9900	FF90754-68	A5953
SC-6	HK0913	-	A1901	A2901	A4900	A3900	A6908	A9900	FF90754-68	A5953
SC-8	HK1113	FF90311-137	A1902	A2902	A4900	A3900	A6910	A9901	FF90754-79	A5962

Match accessories to hose										
Hose Part #	Hose clamp	Heavy duty hose clamp	Round-wire spring guard	Flat-wire spring guard	Nylon (.045) abrasion sleeve	Nylon (.090) abrasion sleeve	Silicone fiberglass Firesleeve	Poly hose guard	Guardian sleeve*	Bend restrictor
										
<b>SC-10</b>	HK1213	FF90311-171	A1904	A2904	A4900	A3900	A6912	A9902	FF90754-91	A5975
<b>SC-12</b>	HK1413	FF90311-190	A1905	A2905	A4900	A3900	A6914	A9902	FF90754-122	A5984
<b>SC-16</b>	HK1913	FF90311-266	A1912	A2909	A4902	A3902	A6920	A9903	FF90754-157	-
<b>WH004-12</b>	HK1913	FF90311-280	A1910	A2910	A4904	A3904	A6922	A9903	FF90754-219	-
<b>WH004-16</b>	HK2317	FF90311-334	A1913	A2913	A4904	A3904	A6928	A9903	FF90754-288	-
<b>WH004-20</b>	HK2617	FF90311-400	A1916	A2917	A4905	A3905	A6932	A9904	FF90754-366	-
<b>WH004-24</b>	HK3217	FF90311-483	A1917	A2917	A4906	A3906	A6936	A9904	FF90754-366	-
<b>WH004-32</b>	HK3417	FF90311-572	-	-	A4908	A3908	A6946	A9904	-	-

## **Weatherhead**

---



Weatherhead by Danfoss

## Machines and tooling



## Weatherhead

Crimp machines

# Core crimp machines

With the Danfoss branded core crimp machine portfolio, all customers have access to the same crimp machines and tooling. This simplified and improved offering includes lower cost options as well as both positive stop and variable machines to meet all of your application needs. Compare our new offering of crimp machines and their associated features to understand which crimper is best for you.



Quick reference crimp machine comparison chart				
<b>Crimp Machines</b>				
<b>Production volume</b>	Low	Low	Medium	Medium
<b>Type</b>	Variable	Positive stop	Variable	Positive stop
<b>Capability-braided "up to"</b>	1-1/4"	1"	1-1/4"	1-1/4"
<b>Capability-spiral "up to"</b>	1"	1"	1-1/4"	1-1/4"
<b>Capability-industrial "up to"</b>	1-1/4"	1"	1-1/4"	1-1/4"
<b>Application</b>	Portable, job shops, maintenance departments	Portable, job shops, maintenance departments	Hose distributors, small assembly shops	Hose distributors, small assembly shops, factory, construction, mines
<b>*Pump options</b>	110v, air/hydraulic, 12v, hand pump	110v, air/hydraulic, 12v, hand pump	115v, 230v	110v, 220v

\*Capabilities based on Danfoss core hose and fitting products

\*See pump ordering options for each machine for specific kit numbers

# Core crimp machines (cont.)

Quick reference crimp machine comparison chart

<p><b>Crimp Machines</b></p>			
<p><b>Production volume</b></p>	<p>Medium/high</p>	<p>Medium</p>	<p>High</p>
<p><b>Type</b></p>	<p>Variable</p>	<p>Positive stop</p>	<p>Variable</p>
<p><b>Capability-braided (up to)</b></p>	<p>2"</p>	<p>2"</p>	<p>3"</p>
<p><b>Capability-spiral (up to)</b></p>	<p>2"</p>	<p>2"</p>	<p>2.5"</p>
<p><b>Capability-industrial (up to)</b></p>	<p>2"</p>	<p>2"</p>	<p>4"</p>
<p><b>Application</b></p>	<p>Hose distributors, assembly shops</p>	<p>Hose distributors, assembly shops, construction, mines</p>	<p>Industrial production facility, specialty</p>
<p><b>*Pump options</b></p>	<p>115v, 230v</p>	<p>220v</p>	<p>230v, 380v, 400v, 420v, 440v, 460v, 480v</p>

\*Capabilities based on Danfoss core hose and fitting products

\*See pump ordering options for each machine for specific kit numbers



# Weatherhead

## Crimp machines

### ET1187

#### Portable crimp machine

The ET1187 machine is our most economical variable crimp machine to date. It boasts a broad crimp capability with a new "ease-of-use" that is sure to excite hose assemblers in the field.



This machine is designed to easily adjust to Danfoss' core products. It's as simple as turning the collar to the correct color to match the layline on the hose, adjust the ring so that the correct size dot aligns with the correct size line on the collar and the machine is set for the correct crimp. Load the correct crimp die based on the crimp die chart attached to the machine, and the machine is ready to crimp.

Tooling	Tooling capabilities			Tooling packages	
	1 wire braid: Z/Winner	2 wire braid: Z/Winner	4 wire spiral: 4S	ET4020TP-0002	ET4020TP-0003
Die cage part #					
<b>FT1380-200-M150</b>	-4	-4		X	X
<b>FT1380-200-M180</b>	-6	-4†		X	X
<b>FT1380-200-M210</b>	-8	-6	-6	X	X
<b>FT1380-200-M240</b>	-10	-8	-8††	X	X
<b>FT1381-200-M280</b>	-12	-10, -12†	-8, -10	X	X
<b>FT1380-200-M320</b>		-12	-12	X	X
<b>FT1380-200-M370</b>	-16	-16		X	X
<b>FT1380-200-M420</b>			-16		X
<b>FT1382-200-M465</b>	-20	-20			X

†Die cage used to crimp Winner hose with two piece Winner fitting

††Die cage used to crimp Winner hose with 4S fitting

\*Consult the PowerSource Crimp Spec tool for the die cage needed to crimp -16 Winner two piece fittings

**NOTE:** Visit the Danfoss PowerSource Crimp Specs tool at [danfoss.com/crimp](http://danfoss.com/crimp) to find the tooling needed for all of the hoses and fittings you plan to crimp

#### Specifications

##### Dimensions:

22" high x 9" wide x 11" deep

##### Weight:

65 lbs

Available with bench and truck mount brackets



Bench mount    Truck mount

#### Capabilities

- **Braided hose:** -4 thru -20
- **Spiral hose:** -6 thru -16

#### Features

- Can be mounted on service vehicles or bench tops
- Can be used remotely, 65lbs
- Can be powered with virtually any 10,000 psi hydraulic power source (minimum of 36 cu. inch pump reservoir capacity is required)
- Utilizes existing FT1380 dies

#### Benefits

- Color-coded collar for core hose products makes setup fast and easy
- Easily transported between job sites
- Versatile power source options
- Lower investment cost than other variable crimpers
- Comes with high efficiency PTFE grease



# ET1187

## Portable crimp machine

### ET1187-001

Bench mount machine, no pump, no tooling (includes bracket) — for premium hose GH681/H180, GH781/H280, GH493/H430)

### ET1187-011

Bench mount machine, no pump, no tooling (includes bracket) — for premium hose GH681/H180, GH781/H280, EC881/H881)

### ET1187-002

Truck mount machine, no pump, no tooling (includes bracket) — for premium hose GH681/H180, GH781/H280, GH493/H430)

### ET1187-012

Truck mount machine, no pump, no tooling (includes bracket) — for premium hose GH681/H180, GH781/H280, EC881/H881)

### ET1187-003

Bench mount machine, no pump, no tooling (includes bracket) — for Winner hose EC115, EC215, EC118

### ET1187-004

Truck mount machine, no pump, no tooling (includes bracket) — for Winner hose EC115, EC215, EC118

### ET1187-008

Contains ET1187 Bench mount machine (includes bracket) for premium hose, 110v pump kit, and ET4020TP-0002 tooling package

### ET1187-010

Contains ET1187-001 bench mount crimper, ET9000-45-110 portable saw, 110v pump, ET4020TP-0002 tooling package, and the ET1187-0029 crimper portability kit

### ET1000PK-001

2-Stage hand pump

### ET1000PK-002

Air/hydraulic pump

### ET1000PK-003

110v electric pump

### ET1000PK-004

12v DC electric pump

\*These pump kits include the pump, connecting hose assembly, and all of the adapters necessary to connect the pump to the ET1187 crimp machine

### T-400-G

1.5 oz. tube, high efficiency PTFE grease

### FF91455

16 oz. can, high efficiency PTFE grease

### ET1187C-0008PR

Replacement barrel for the ET1187-001 or ET1187-002 machine (for premium hose GH681/H180, GH781/H280, GH493/H430)

### ET1187C-0008PR2

Replacement barrel for the ET1187-001 or ET1187-002 machine (for premium hose GH681/H180, GH781/H280, EC881/H881)

### ET1187C-0008WR

Replacement barrel for the ET1187-003 or ET1187-004 machine (for Winner hose EC115, EC215, EC415)

### ET1187C-0009PR

Replacement knob for the ET1187-001 or ET1187-002 machine (for premium hose GH681/H180, GH781/H280, GH493/H430)

### ET1187C-0009PR2

Replacement knob for the ET1187-001 or ET1187-002 machine (for premium hose GH681/H180, GH781/H280, EC881/H881)

### ET1187C-0009WR

Replacement knob for the ET1187-003 or ET1187-004 machine (for Winner hose EC115, EC215, EC118)

### ET1187C-0017

Bench mount bracket (separate)

### ET1187C-0019

Truck mount bracket (separate)

### ET1187C-0028

Handle kit  
Includes 2 easy grip handles and mounting hardware

### ET1187C-0029

Portability kit  
Includes handle kit, longer hose assembly, and FF series QD couplings

### FT1380DR-12

Lazy Susan die rack  
Holds twelve FT1380 dies

### ET1187C-COVER

Crimper Cover

**Place your order for the desired machine, pump, and tooling separately,** following the chart below  
OR order a machine package with tooling and include the part number ET1187-008 and part number ET1187-010.

### Tooling can also be ordered a la carte.

Visit the Danfoss PowerSource Crimp Specs tool at [danfoss.com/crimp](http://danfoss.com/crimp) to find the tooling needed for all of the hoses and fittings you plan to crimp.

ET1187 ordering			Package with tooling
Select your base machine	Select your pump kit	Select your tooling package	Order a machine package with tooling
<b>ET1187-001</b> Base machine with bench mount only	<b>ET1000PK-003</b> 110v pump kit	<b>ET4020TP-0002</b>	<b>ET1187-008</b>
<b>ET1187-002</b> Base machine with truck mount only	<b>ET1000PK-002</b> A/H pump kit	<b>ET4020TP-0003</b>	<b>ET1187-010</b>
<b>ET1187-003</b> Base machine with bench mount only (for Winner hose EC115, EC215, EC415)	<b>ET1000PK-004</b> 12v pump kit		
<b>ET1187-004</b> Base machine with truck mount only (for Winner hose EC115, EC215, EC415)	<b>ET1000PK-001</b> Hand pump kit		

**Note:** All available pump kits shown include hose assembly and are CSA compliant

# Weatherhead

## Crimp machines

### ET1000

#### Portable crimp machine

The portable ET1000 crimp machine boasts a broad crimp capability with an ease-of-use that is sure to please hose assemblers. With four pump options—air/hydraulic, hand, 110v, or 12v DC—this portable machine can travel to the worksite. The machine comes equipped with a stand pre-drilled for mounting to a workbench or table-top.



Tooling	Tooling capabilities			Tooling packages	
	1 wire braid Z/Winner	2 wire braid Z/Winner	4 wire spiral 4S	*ET1000TP-1002 New placement package	*ET1000TP-1001 Conversion package
Die cage part #					
<b>ET313DC-4Z</b>	-4	-4		X	X
<b>ET313DC-5Z</b>	-5	-5			
<b>ET313DC-6Z</b>	-6	-6		X	X
<b>ET313DC-8Z</b>	-8	-8		X	X
<b>ET313DC-10Z</b>	-10	-10			
<b>ET1000DC-12Z</b>	-12	-12		X	X
<b>ET1000DC-16Z</b>	-16	-16		X	X
<b>ET313DC-4S6</b>			-6		
<b>ET313DC-4S8</b>			-8	X	X
<b>ET313DC-4S10</b>			-10		
<b>ET1000DC-4S12</b>			-12	X	X
<b>ET1000DC-4S16</b>			-16	X	X

\*ET1000TP-1002 includes the following spacer rings—ET425SR-150A, ET313SR-090A, ET313SR-030D  
 \*ET1000TP-1002 includes pusher extension—ET1000C-0012  
 \*ET1000TP-1002 includes adapter ring—ET1000AR-001  
 \*ET1000TP-1001 includes the following spacer rings—ET425SR-150A, ET313SR-090A

**NOTE:** Visit the Danfoss PowerSource Crimp Specs tool at [danfoss.com/crimp](http://danfoss.com/crimp) to find the tooling needed for all of the hoses and fittings you plan to crimp

#### Specifications

**Dimensions:**  
22" high x 16" wide x 14" deep

**Weight:** 65 lbs

Available with bench and truck mount brackets

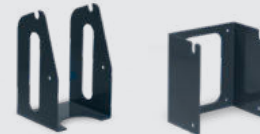

Bench mount      Truck mount

#### Capabilities

- **Braided hose:** -4 thru -16
- **Spiral hose:** -6 thru -16

#### Features

- Portable, positive stop, economical
- Can be mounted on service vehicles
- Utilizes 2-piece collet assemblies
- Spacer rings control the crimp diameter

#### Benefits

- Sliding pusher allows for easier fitting insertion into the machine
- Simple positive-stop crimp diameter control system for consistent crimping time after time with no operator adjustments required
- Easily transported between job sites
- Versatile power source options
- Electricity is required only when using an electric pump
- Comes with high efficiency PTFE grease

# ET1000

## Portable crimp machine

### ET1000-001

Base machine

### ET1000-020

Contains ET1000 crimper, / 110v pump kit, and ET1000TP-1002 tooling package

### ET1000-021

Contains ET1000 crimper, air/hydraulic pump kit, and ET1000TP-1002 tooling package

### ET1000-022

Contains ET1000-001 bench mount crimper, ET9000-45-110 portable saw, 110v pump, ET4020TP-0002 tooling package, and the ET1187-0029 crimper portability kit

### ET1000PK-001

Hand pump

### ET1000PK-002

Air/hydraulic pump

### ET1000PK-003

110 volt electric pump

### ET1000PK-004

12 volt DC electric pump

\*Pump kits contain hose assembly and fittings to attach pump to machine

### T-400-G

1.5 oz. tube high efficiency PTFE grease

### FF91455

16 oz. can, high efficiency PTFE grease

### ET1187C-0028

Handle kit  
Includes 2 easy grip handles and mounting hardware

### ET1187C-0029

Portability kit  
Includes handle kit, longer hose assembly, and FF series QD couplings

### ET1000C-0021

Wall bracket

### ET1000C-0001

Bench mount bracket (included with base machine)

### ET1187C-COVER

Crimper Cover

For your convenience, we have created one to two optimized machine and tooling package options for each of the core crimp machines. **If the available options do not meet your needs, place your order for the desired machine, pump, and tooling separately,** following the chart below.

**Tooling can also be ordered a la carte.** Visit the Danfoss PowerSource Crimp Specs tool at [danfoss.com/crimp](http://danfoss.com/crimp) to find the tooling needed for all of the hoses and fittings you plan to crimp.

ET1000 ordering		
Select your base machine	Select your pump kit	Select your tooling package
<b>ET1000-001</b> Base ET1000 Machine	<b>ET1000PK-003</b> 110v pump kit	<b>ET1000TP-1002</b> New placement tooling package
	<b>ET1000PK-002</b> A/H pump kit	<b>ET1000TP-1001</b> Conversion tooling package
	<b>ET1000PK-004 1</b> 2v pump kit	
	<b>ET1000PK-001</b> Hand pump kit	

Package with tooling
Order a machine package with tooling
<b>ET1000-020</b>
<b>ET1000-021</b>
<b>ET1000-022</b>

**NOTE:** All available pump kits shown include hose assembly and are CSA compliant

## Weatherhead

### Crimp machines

## FT1380/FT1380e

### General purpose crimp machine

The FT1380 crimp machine from Danfoss crimps all your hose needs up to and including -20 spiral wire hose. The FT1380 is electronically controlled to give fast, accurate crimps the first time and every time you need a hose assembly. The electronic keypad is easy to adjust, with up to 10 programmable crimp settings. For hose styles and sizes used less frequently, simply enter the 3 digit code of that hose.

For FT1380e specifications and ordering details, please refer to:  
FT1380e Electronic Crimper by Danfoss: [Spec Sheet AV418159937321en-000201](#)



Tooling	Tooling Capabilities				Tooling Packages	
	1 wire braid Z/Winner	2 wire braid Z/Winner	4 wire spiral 4S	6 wire spiral 6S	ET4020TP-0002	ET4020TP-0003
Die cage part #						
<b>FT1380-200-M150</b>	-4	-4			X	X
<b>FT1380-200-M180</b>	-6	-4 <sup>†</sup>			X	X
<b>FT1380-200-M210</b>	-8	-6	-6		X	X
<b>FT1380-200-M240</b>	-10	-8	-8 <sup>††</sup>		X	X
<b>FT1381-200-M280</b>	-12	-10,-12 <sup>†</sup>	-8,-10		X	X
<b>FT1380-200-M320</b>		-12	-12		X	X
<b>FT1380-200-M370</b>	-16	-16			X	X
<b>FT1380-200-M420</b>			-16			X
<b>FT1382-200-M465</b>	-20	-20	-20	-16		X
<b>FT1382-275-M520</b>				-20		

<sup>†</sup>Die cage used to crimp designated hose diameter with two piece Winner fitting

<sup>††</sup>Die cage used to crimp Winner hose with 4S fitting

\*Consult the PowerSource Crimp Spec tool for the die cage needed to crimp -16 Winner two piece fittings

**NOTE:** Visit the Danfoss PowerSource Crimp Specs tool at [danfoss.com/crimp](http://danfoss.com/crimp) to find the tooling needed for all of the hoses and fittings you plan to crimp

#### FT1380-115/FT1380e-115

Base machine with 115v pump

#### FT1380-115CSA/FT1380e-115CSA

Base machine with 115v pump, CSA approved

#### FT1380-230/FT1380e-230

Base machine with 230v pump

#### FT1380-230CSA/FT1380e-230CSA

Base machine with 230v pump, CSA approved

All pumps are included with machine purchase. To review machine and pump package options please refer to the ordering options on the following page.

#### FT1380-115-8

Contains FT1380 crimper, 115v pump, and ET4020TP-0003 tooling package

#### FT1380-115-8CSA

Contains FT1380 crimper, 115v pump, and ET4020TP-0003 tooling package, CSA approved

#### FT1380e-115-9

Contains FT1380e crimper, 115v pump, and ET4020TP-0003 tooling package

#### FT1380e-115-9CSA

Contains FT1380e crimper, 115v pump, and ET4020TP-0003 tooling package, CSA approved

### Specifications

#### Dimensions:

28.5" high x 12.75" wide x 25.75" deep

**Weight:** 238 lbs.

### Capabilities

- **Braided hose:** -4 thru -20
- **Spiral hose:** -6 thru -20

### Features

#### FT1380e

- FT1380e model features pre-loaded crimp specs, unlimited favorites, color assembly photos, and administrator capabilities

#### FT1380/FT1380e

- User-friendly operation to minimize training and mistakes
- Pre-set crimp settings and simple die cage insertion reduce setup time
- Electronic controls for minimal maintenance
- Upright design for easy hose insertion
- Compact design that requires little space

### Benefits

#### FT1380e

- FT1380e model increases operator safety, speeds up assembly process, and reduces operator error and waste

#### FT1380/FT1380e

- Easy and quick to electronically enter crimp settings
- Can pre-program 10 most popular crimp settings
- Die cages easily slip in and out of machine
- Comes with high efficiency PTFE grease
- FT1380e comes with USB drive, stylus, and microfiber cloth

## FT1380/FT1380e

### General purpose crimp machine

#### FT1380-2-4

Optional die holder kit—kit includes 4 die holder plates each of which will hold 2 die cages. Holes are pre-drilled on base of FT1380 machine to accept these 4 plates. Not intended for use with the FT1380e electronic crimp machine.

#### FT1380-4

Optional fitting backstop—kit includes backstop and 5/32" hex wrench. The backstop allows the FT1380 to crimp PTFE hose and to be utilized for a fitting locator to increase efficiency.

#### FT1330-XL

Z fitting locators

#### FT1380-XL

4S fitting locators

#### T-400-G

1.5 oz. tube high efficiency PTFE grease

#### FF91455

16 oz. can, high efficiency PTFE grease

#### FT1380-2-9

Die cage repair kits for FT1380-200-size, FT1380-275-size

#### FF91042

Crimper cart

#### FT1380DR-12

Lazy Susan die rack

Holds twelve FT1380 dies

Standard FT1380 crimpers can be upgraded to the FT1380e electronic platform.

#### FT1380e-115-UP

#### FT1380e-115-UPCSA

#### FT1380e-230-UP

#### FT1380e-230-UPCSA

For your convenience, we have created one to two optimized machine and tooling package options for each of the core crimp machines. **If the available options do not meet your needs, place your order for the desired machine, pump, and tooling separately,** following the chart below.

**Tooling can also be ordered a la carte.** Visit the Danfoss PowerSource Crimp Specs tool at [danfoss.com/crimp](http://danfoss.com/crimp) to find the tooling needed for all of the hoses and fittings you plan to crimp.

FT1380/FT1380e ordering		
Select your base machine	Pump included	Select your tooling package
<b>FT1380-115/FT1380e-115</b> Base machine with 115v pump	115v pump included	<b>ET4020TP-0003</b>
<b>FT1380-115CSA/FT1380e-115CSA</b> Base machine with 115v pump, CSA approved	115v pump included	<b>ET4020TP-0002</b>
<b>FT1380-230/FT1380e-230</b> Base machine with 230v pump	230v pump included	
<b>FT1380-230CSA/FT1380e-230CSA</b> Base machine with 230v pump, CSA approved	230v pump included	

Package with tooling
Order a machine package with tooling:
<b>FT1380-115-8</b>
<b>FT1380-115-8CSA</b>
<b>FT1380e-115-9</b>
<b>FT1380e-115-9CSA</b>

Note: Consider an alternative positive stop machine when crimping large quantities of -20 90 degree fittings.

Specialty crimp die cages		
Tooling	Tooling capabilities	
Die cage part #	Hose size	Hose style
<b>FT1380-275-M070</b>	-03	PTFE
<b>FT1380-275-M090</b>	-03 Synflex, -04, -05 PTFE	Synflex, PTFE
<b>FT1380-275-M120</b>	-04 Synflex, -06 PTFE	Synflex, PTFE
<b>FT1382-275-M370</b>	-16	Two-piece Winner
<b>FT1382-275-M520</b>	-20	6S
<b>*FT1380-275-R5-04</b>	-04	Truck and fuel 100R5
<b>*FT1380-275-R5-05</b>	-05	Truck and fuel 100R5
<b>*FT1380-275-R5-06</b>	-06	Truck and fuel 100R5
<b>*FT1380-275-R5-08</b>	-08	Truck and fuel 100R5
<b>*FT1380-275-R5-10</b>	-10	Truck and fuel 100R5
<b>*FT1380-275-R5-12</b>	-12	Truck and fuel 100R5
<b>*FT1380-275-R5-16</b>	-16	Truck and fuel 100R5
<b>*FT1380-275-R5-20</b>	-20	Truck and fuel 100R5

\*Tooling above for use with Weatherhead hose and fittings

## Weatherhead

### Crimp machines

# T-420

## General purpose crimp machine

The T-420 is a versatile machine ideal for your shop, factory, construction, and mine locations. Large capacity combined with lever-activated crimping gives you wide coverage and a quick and simple way to make factory-quality hose assemblies.



Tooling	Tooling capabilities			Tooling packages	
	1 wire braid Z/Winner	2 wire braid Z/Winner	4 wire spiral 4S	T420TP-1001	*T420TP-1002 (for Winner hose with Z fittings)
Die cage part #					
<b>ET425DC-4Z</b>	-4	-4		X	X
<b>ET425DC-5Z</b>	-5	-5			
<b>ET425DC-6Z</b>	-6	-6		X	X
<b>ET425DC-8Z</b>	-8	-8		X	X
<b>ET425DC-10Z</b>	-10	-10			
<b>ET425DC-12Z</b>	-12	-12		X	X
<b>ET425DC-16Z</b>	-16	-16		X	X
<b>ET425DC-20Z</b>	-20	-20			X
<b>ET425DC-4S6</b>			-6		X
<b>ET425DC-4S8</b>			-8	X	X
<b>ET425DC-4S10</b>			-10		
<b>ET425DC-4S12</b>			-12	X	X
<b>ET425DC-4S16</b>			-16	X	X
<b>ET425DC-4S20</b>			-20	X	X

\*T420TP-1001 includes spacer ring ET425SR-105A

\*T420TP-1001 includes adapter ring ET425AR-14

\*T420TP-1002 includes adapter ring ET425AR-14

\*T420TP-1002 includes the following spacer rings—ET425SR-075A, ET425SR-030D, ET425SR-015A, ET425SR-060D, ET425SR-030A, ET425SR-045A, ET425SR-015D, ET425SR-060A, ET425SR-165A, ET425SR-105A, ET425SR-090A

**NOTE:** Visit the Danfoss PowerSource Crimp Specs tool at [danfoss.com/crimp](http://danfoss.com/crimp) to find the tooling needed for all of the hoses and fittings you plan to crimp

### Specifications

#### Dimensions:

22" high x 10" wide x 20-1/2" dee

**Weight:** 210 lbs

#### Capabilities

- **Braided hose:** -4 thru -20
- **Spiral hose:** -6 thru -20

#### Features

- Positive stop, economical
- Utilizes 2-piece collet assemblies
- Spacer rings control the crimp diameter
- Can be mounted on a bench, the C-40X cabinet, or the FF91042 crimper cart

#### Benefits

- Simple positive-stop crimp diameter control system for consistent crimping time after time with no operator adjustments required
- Versatile power source options
- Comes with high efficiency PTFE grease

# T-420

## General purpose crimp machine

### T-420-1

Base T-420 machine

### T-420-1CSA

Base T-420 machine, CSA approved

### T-420-001

Contains T-420 crimper, 220v pump kit, T420TP-1001 tooling package

### T-420-002

Contains T-420 crimper, 110v pump kit, T420TP-1001 tooling package

### T-420-001CSA

Contains T-420 crimper, 220v pump kit, T420TP-1001 tooling package, CSA approved

### T-420-002CSA

Contains T-420 crimper, 110v pump kit, T420TP-1001 tooling package, CSA approved

### ET420-007

110 volt electric pump

### ET420-007CSA

110 volt electric pump, CSA approved

### ET420-008

220 volt electric pump

### ET420-008CSA

220 volt electric pump, CSA approved

### T-400-G

1.5 oz. tube high efficiency PTFE grease

### FF91455

16 oz. can, high efficiency PTFE grease

### FF91042

Crimper cart

For your convenience, we have created one to two optimized machine and tooling package options for each of the core crimp machines. **If the available options do not meet your needs, place your order for the desired machine, pump, and tooling separately,** following the chart below.

**Tooling can also be ordered a la carte.** Visit the Danfoss PowerSource Crimp Specs tool at [danfoss.com/crimp](http://danfoss.com/crimp) to find the tooling needed for all of the hoses and fittings you plan to crimp.

T-420 ordering		
Select your base machine	Select your pump kit	Select your tooling package
<b>T-420-1</b> Base T-420 machine	<b>ET420-007</b> 110v pump	<b>T420TP-1001</b>
<b>T-420-1CSA</b> Base T-420 machine, CSA approved	<b>ET420-007CSA</b> 110v pump, CSA approved	<b>T420TP-1002</b> (for Winner hose with Z fittings)
	<b>ET420-008</b> 220v pump	
	<b>ET420-008CSA</b> 220v pump, CSA approved	

Package with tooling
Order a machine package with tooling
<b>T-420-001</b>
<b>T-420-002</b>
<b>T-420-001CSA</b>
<b>T-420-002CSA</b>

## Weatherhead

### Crimp machines

# FT1390

## General purpose crimp machine

The FT1390 crimp machine is a stand-alone machine and will crimp up to 2" braided, 2" four spiral, and 2" six spiral hydraulic hose assemblies. It boasts a programmable electronic keypad with 10 presets.

This keypad simplifies the hose crimping operation by allowing the machine operator to enter a predetermined setting for a specific hose type and size. The ten most often used crimp settings can be stored for one-touch retrieval. The machine will automatically crimp to the exact crimp diameter required for that hose type and size. The electronic crimp machine settings eliminate the need for spacers or shims in the crimping operation.



Tooling	Tooling capabilities				Tooling packages	
	1 wire braid Z/Winner	2 wire braid Z/Winner	4 wire spiral 4S	6 wire spiral 6S	ET4040TP-0007	ET4040TP-0008
Die cage part #						
<b>FT1307-200-M150</b>	-4	-4			X	
<b>FT1307-200-M180</b>	-6				X	
<b>FT1307-200-M210</b>	-8	-6	-6		X	
<b>FT1307-200-M240</b>	-10	-8			X	
<b>FT1307-200-M280</b>	-12	-10, -12†	-8, -10		X	
<b>FT1307-200-M320</b>		-12			X	
<b>FT1307-200-M370</b>	-16	-16			X	
<b>FT1307-200-M420</b>	-20		-16		X	
<b>FT1307-200-M465</b>	-20	-20			X	
<b>FT1307-200-M520</b>	-24				X	
<b>FT1307-200-M550</b>	-32††	-24			X	
<b>FT1307-200-M690</b>	-32	-32			X	
<b>FT1209-200-82</b>			-12		X	
<b>FT1209-200-15</b>		-24†				
<b>FT1209-200-46</b>		-20†				
<b>*FT1390-200-14</b>			-20			X
<b>*FT1390-200-20</b>			-24			X
<b>*FT1390-200-23</b>			-32			X
<b>*FT1390-200-15</b>				-20		
<b>*FT1390-200-16</b>				-24		
<b>*FT1390-200-21</b>		-40		-32		

\*Die cages are hinged for ease of use when crimping large elbows

†Die cage used to crimp designated hose diameter with two piece Winner fitting

††Die cage used to crimp Winner hose with Z fitting

**NOTE:** Visit the Danfoss PowerSource Crimp Specs tool at [danfoss.com/crimp](http://danfoss.com/crimp) to find the tooling needed for all of the hoses and fittings you plan to crimp

### Specifications

#### Dimensions:

49" high, 29" wide, 28" deep

#### Weight: 825 lbs

### Capabilities

• **Braided hose:** -4 thru -32

• **Spiral hose:** -6 thru -32

### Features

- Front-end loading design
- Electronic keypad control of crimp diameter
- Power return stroke, return limit control
- Drop-in tooling (crimp die cages)
- Backstop fitting locator
- Worklamp equipped
- Includes footswitch

### Benefits

- Easy and quick to electronically enter crimp setting
- Can pre-program 10 most popular crimp settings
- Die cages easily slip in and out of machine
- Comes with high efficiency PTFE grease



# FT1390

## General purpose crimp machine

### FT1390-115

Base machine with 115v pump

### FT1390-115CSA

Base machine with 115v pump, CSA approved

### FT1390-230

Base machine with 230v pump

### FT1390-230CSA

Base machine with 230v pump, CSA approved

All pumps are included with machine purchase.

To review machine and pump package options please refer to the ordering options below.

### T-400-G

1.5 oz. tube high efficiency PTFE grease

### FF91455

16 oz. can, high efficiency PTFE grease

### FT1390-115-12

Contains FT1390 crimper with 115v pump, and ET4040TP-0007 tooling package

### FT1390-115-12CSA

Contains FT1390 crimper with 115v pump, and ET4040TP-0007 tooling package, CSA approved

For your convenience, we have created one to two optimized machine and tooling package options for each of the core crimp machines. **If the available options do not meet your needs, place your order for the desired machine, pump, and tooling separately**, following the chart below.

**Tooling can also be ordered a la carte.** Visit the Danfoss PowerSource Crimp Specs tool at [danfoss.com/crimp](http://danfoss.com/crimp) to find the tooling needed for all of the hoses and fittings you plan to crimp.

### FT1390 ordering

Select your base machine	Pump included	Select your tooling package
<b>FT1390-115</b> Base machine with 115v pump	<b>FT1390-115</b> 115v pump included	<b>ET4040TP-0007</b>
<b>FT1390-115CSA</b> Base machine with 115v pump, CSA approved	<b>FT1390-115CSA</b> 115v pump included	<b>ET4040TP-0008</b>
<b>FT1390-230</b> Base machine with 230v pump	<b>FT1390-230</b> 230v pump included	
<b>FT1390-230CSA</b> Base machine with 230v pump, CSA approved	<b>FT1390-230CSA</b> 230v pump included	

### Package with tooling

Order a machine package with tooling

**FT1390-115-12**

**FT1390-115-12CSA**

## Weatherhead

Crimp machines

### FT1390

General purpose crimp machine (cont.)



Specialty crimp die cages		
Tooling	Tooling capabilities	
Die cage part #	Hose size	Hose style
FT1209-200-14	-20	4S
FT1209-200-15	-20	6S
FT1209-200-16	-24	6S
FT1209-200-20	-24	4S
FT1209-200-21	-32	6S
FT1209-200-23	-32	4S
FT1390-200-21	-40	2B
FT1307-200-M070	-03 PTFE	PTFE
FT1307-200-M090	-03 Synflex, -04, -05 PTFE	Synflex, PTFE
FT1307-200-M120	-04 Synflex, -06 PTFE	Synflex, PTFE

**NOTE:** Additional dies and die cage assemblies also available. Refer to website or contact Danfoss

**NOTE:** FT1209-200-size & FT1390-200-size are for use with internal skive and 4S/6S fittings (SAE100R11 & SAE100R13 hose styles).

**NOTE:** FT1390-200-size dies cages are hinged to allow ease of use when crimping large elbows

Barrel crimp die cages		
Die cage part #	Hose size	Hose style
FT1307-200-R5-04	-04	Truck and fuel 100R5
FT1307-200-R5-05	-05	Truck and fuel 100R5
FT1307-200-R5-06	-06	Truck and fuel 100R5
FT1307-200-R5-08	-08	Truck and fuel 100R5
FT1307-200-R5-10	-10	Truck and fuel 100R5
FT1307-200-R5-12	-12	Truck and fuel 100R5
FT1307-200-R5-16	-16	Truck and fuel 100R5
FT1307-200-R5-20	-20	Truck and fuel 100R5
FT1307-200-R5-24	-24	Truck and fuel 100R5
FT1307-200-R5-32	-32	Truck and fuel 100R5
*FT1392-200-R5-24	-24	Truck and fuel 100R5
*FT1392-200-R5-32	-32	Truck and fuel 100R5

\*Hinged die cage

**NOTE:** Tooling above for use with Weatherhead hose and fittings

Die cage repair kits	
Die cage part #	Order
FT1307-200-size	FT1307-2-9
FT1390-200-size	FT1390-2-9
FT1209-200-size	FT1209-2-9

Crimp machines

## Weatherhead

### Crimp machines

# ET4001

## General purpose crimp machine

The ET4001 is ideal for factory, high-performance machine operations, construction and mine locations. This machine offers the capabilities of crimping all of the crimp-style hose ends through -32. With this coverage, this heavy-duty crimper can handle all of your crimping needs.



Tooling	Tooling capabilities				Tooling packages			
	Die cage part #	1- wire braid Z/Winner	2- wire braid Z/Winner	4 wire spiral 4S	6 wire spiral 6S	*ET4001TP-1002 new placement package	*ET4001TP-1001 conversion package	*ET4001TP-1003 (for Winner hose with Z fittings)
ET525DC-4Z	-4	-4				X	X	X
ET525DC-5Z	-5	-5						X
ET525DC-6Z	-6	-6				X	X	X
ET525DC-8Z	-8	-8				X	X	X
ET525DC-10Z	-10	-10						X
ET525DC-12Z	-12	-12				X	X	X
ET525DC-16Z	-16	-16				X	X	X
ET525DC-20Z	-20	-20						X
ET525DC-24Z	-24	-24						X
ET525DC-32Z	-32	-32						X
ET525DC-4S6				-6				X
ET525DC-4S8				-8		X	X	X
ET525DC-4S10				-10				
ET525DC-4S12				-12		X	X	X
ET525DC-4S16				-16		X	X	X
ET525DC-4S20				-20		X	X	X
ET575DC-4S24				-24		X	X	X
ET575DC-4S32				-32		X	X	X
ET525DC-6S20					-20			
ET575DC-6S24					-24			
ET575DC-6S32					-32			

\*ET4000AR-001 adapter ring included with base machine

\*ET4001TP-1002 includes the following spacer rings -  
ET575SR-135A, ET525SR-120A, ET525SR-180A,  
ET525SR-225A, ET525SR-240A

\*ET4001TP-1002 includes adapter ring ET4000AR-002

\*ET4001TP-1001 includes the following spacer rings—ET575SR-135A, ET525SR-120A

\*ET4001TP-1003 includes the following spacer rings—ET525SR-030A, ET575SR-120A, ET575SR-015A,  
ET525SR-075A, ET525SR-015A, ET525SR-180A, ET525SR-090A, ET525SR-075D, ET525SR-045A,  
ET525SR-240A, ET525SR-015D, ET525SR-060A, ET525SR-195A, ET525SR-120A, ET525SR-105A

**NOTE:** Visit the Danfoss PowerSource Crimp Specs tool at [danfoss.com/crimp](http://danfoss.com/crimp) to find the tooling needed for all of the hoses and fittings you plan to crimp

### Specifications

#### Dimensions:

29" high, 12" wide, 21" deep

**Weight:** 550 lbs

### Capabilities

- **Braided Hose:** -4 thru -32
- **Spiral Hose:** -6 thru -32

### Features

- Positive stop
- Features a two-stage pump providing high flow at low pressure for fast ram approach and low flow at high pressure for actual crimping
- Can be mounted on a bench, work table, or the FF91042 crimper cart

### Benefits

- Ideal for factory, construction and mine locations
- Crimps up to 2" 6 wire spiral hose
- Comes with high efficiency PTFE grease

# ET4001

## General purpose crimp machine

### ET4001-004

Base ET4001 machine with hose kit, pump, work lamp

### ET4001-004CSA

Base ET4001 machine with hose kit, pump, work lamp, CSA approved

### ET4001P-002

220v single phase electric pump

### T-410-22

36" pump to press hose assembly

### ET4001P-002CSA

220v single phase electric pump, CSA approved

### ET4001-015

Contains ET4001 crimper, 220v pump kit, and ET4001TP-1002 tooling package

### ET4001-015CSA

Contains ET4001 crimper, 220v pump kit, and ET4001TP-1002 tooling package, CSA approved

### T-400-G

1.5 oz. tube high efficiency PTFE grease

### FF91455

16 oz. can, high efficiency PTFE grease

### ET4001C-0017

Magnetic work lamp

### FF91042

Crimper cart

For your convenience, we have created one to two optimized machine and tooling package options for each of the core crimp machines. **If the available options do not meet your needs, place your order for the desired machine, pump, and tooling separately**, following the chart below.

**Tooling can also be ordered a la carte.** Visit the Danfoss PowerSource Crimp Specs tool at [danfoss.com/crimp](http://danfoss.com/crimp) to find the tooling needed for all of the hoses and fittings you plan to crimp.

ET4001 ordering		
Select your base machine	Pump included	Select your tooling package
<b>ET4001-004</b> Base ET4001 machine with hose kit, pump, work lamp	<b>ET4001-004</b> 220v pump included	<b>ET4001TP-1002</b> New placement tooling package
<b>ET4001-004CSA</b> Base ET4001 machine with hose kit, pump, work lamp, CSA approved	<b>ET4001-004CSA</b> 220v pump included	<b>ET4001TP-1003</b> (for Winner hose with Z fittings)
		<b>ET4001TP-1001</b> Conversion tooling package

Package with tooling
Order a machine package with tooling
<b>ET4001-015</b>
<b>ET4001-015CSA</b>

## Weatherhead

### Crimp machines

## ET5070

### Industrial production crimp machine

The ET5070 is designed for high industrial production and comes pre-programmed with all of Danfoss' hose and hose fitting crimp specifications, crimp profile details, and machine settings in order to crimp to Danfoss' specifications. It crimps up to 2.5" spiral, 3" braided and 4" industrial in Danfoss core hose products as well as a wide variety of specialty hose.

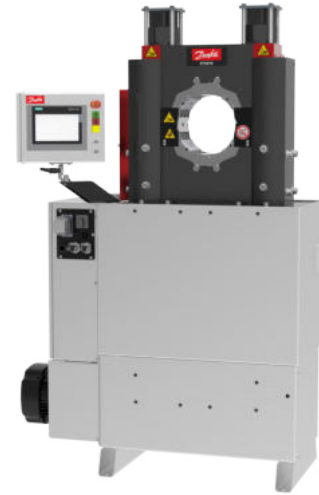

#### Tooling packages: standard die

Standard die set part #	Die size		Die length		Minimum		Crimp range maximum	
	mm	in	mm	in	mm	in	mm	in
ET5040DC-M070S	7,0	0.276	82,0	3.23	7,0	0.28	9,0	0.35
ET5040DC-M090S	9,0	0.354	82,0	3.23	9,0	0.35	12,0	0.47
ET5040DC-M120S	12,0	0.472	82,0	3.23	12,0	0.47	15,0	0.59
*ET5040DC-M150S	15,0	0.590	82,0	3.23	15,0	0.59	18,0	0.71
*ET5040DC-M180S	18,0	0.709	82,0	3.23	18,0	0.71	21,0	0.83
*ET5040DC-M210S	21,0	0.827	82,0	3.23	21,0	0.83	24,0	0.95
*ET5040DC-M240S	24,0	0.945	82,0	3.23	24,0	0.95	28,0	1.10
*ET5040DC-M280S	28,0	1.102	82,0	3.23	28,0	1.10	32,0	1.26
ET5040DC-M320S†	32,0	1.259	82,0	3.23	32,0	1.26	37,0	1.46
ET5040DC-M355S	35,5	1.398	82,0	3.23	35,5	1.40	39,5	1.56
*ET5040DC-M370S	37,0	1.457	82,0	3.23	37,0	1.46	42,0	1.66
*ET5040DC-M420S	42,0	1.654	82,0	3.23	42,0	1.66	46,5	1.83
ET5040DC-M450S	45,0	1.772	82,0	3.23	45,0	1.77	50,0	1.97
*ET5040DC-M465S	46,5	1.831	82,0	3.23	46,5	1.83	52,0	2.05
ET5040DC-M505S	50,5	1.988	82,0	3.23	50,5	1.99	54,0	2.13
*ET5040DC-M520S	52,0	2.047	82,0	3.23	52,0	2.05	55,0	2.17
*ET5040DC-M550S	55,0	2.165	82,0	3.23	55,0	2.17	60,0	2.36
ET5040DC-M570S	57,0	2.244	82,0	3.23	57,0	2.24	64,0	2.52
ET5040DC-M590S	59,0	2.323	82,0	3.23	59,0	2.32	66,0	2.60
ET5040DC-M620S	62,0	2.441	82,0	3.23	62,0	2.44	70,0	2.76
*ET5040DC-M690S	69,0	2.717	82,0	3.23	69,0	2.72	73,0	2.87
ET5040DC-M720S	72,0	2.835	82,0	3.23	72,0	2.84	78,0	3.07
ET5040DC-M775S	77,5	3.051	82,0	3.23	77,5	3.05	85,5	3.37
ET5040DC-M790S	79,0	3.110	82,0	3.23	79,0	3.11	88,0	3.46

\*Included in the ET5040C-0023 standard die kit

†Supplied with all ET5040 crimp machines and required for calibration  
ET5040C-0001 adapter die required for all M series dies and comes standard in each KT machine package.

#### Specifications

##### Dimensions:

67" high x 24" wide x 48" deep

##### Weight:

1,851 lbs  
(without mounting rack and dies)

#### Capabilities

- **Spiral hose:** up to 2.5" (DN51)
- **Braided hose:** up to 3" (DN80)
- **Industrial hose:** up to 6" (DN102)

#### Features

- 315 tons of crimp force
- Designed for high production
- Pre-programmed with Danfoss crimp specs and machine settings
- Crimps up to 2.5" spiral, 3" braided, 4" industrial in core products
- Crimps textile braid, wire braid, spiral hydraulic, thermoplastic, PTFE, air conditioning, and other industrial and specialty hose constructions

#### Benefits

- Ease of use and fast cycle times increase productivity
- Pre-loaded Danfoss crimp specs reduce errors and scrap
- Fast and safe crimp operation
- Grease free dies allow for much easier and cleaner die changeout and reduce chance for operator error due to not having to apply grease to dies and crimp ring
- Convenient die storage rack allows easy access to crimp dies and tooling

## ET5070

### Industrial production crimp machine

Tooling: large bore die								
Standard die set part #	Die size		Die length		Minimum		Crimp range maximum	
	mm	in	mm	in	mm	in	mm	in
ET5040PBL-M740	74,0	2.913	118,0	4.65	74,0	2.92	83,0	3.26
ET5040PBL-M780	78,0	3.070	118,0	4.65	78,0	3.07	86,0	3.38
ET5040PBL-M840	84,0	3.307	118,0	4.65	84,0	3.31	92,0	3.62
ET5040PBL-M860	86,0	3.386	118,0	4.65	86,0	3.39	94,0	3.70
ET5040PBL-M900	90,0	3.543	118,0	4.65	90,0	3.55	99,0	3.89
ET5040PBL-M960	96,0	3.800	118,0	4.65	96,0	3.80	105,0	4.13
ET5040PBL-M1030	103,0	4.055	118,0	4.65	103,0	4.06	113,0	4.44
ET5040PBL-M1060	106,0	4.173	126,0	4.96	106,0	4.18	116,0	4.56
ET5040PBL-M1110	110,0	4.331	126,0	4.96	110,0	4.33	121,0	4.76
ET5040PBL-M1160	116,0	4.567	126,0	4.96	116,0	4.57	127,0	4.99
ET5040PBL-M1210	121,0	4.764	126,0	4.96	121,0	4.77	133,0	5.23
ET5040PBL-M1260	126,0	4.961	126,0	4.96	126,0	4.96	138,0	5.43
ET5040PBL-M1310	131,0	5.157	126,0	4.96	131,0	5.16	144,0	5.66

**NOTE:** Each set includes 8 individual dies

100R5 dies for the ET5070		
Die part #	Hose size	Hose style
ET5040DC-R5-04	-04	Truck and fuel 100R5
ET5040DC-R5-05	-05	Truck and fuel 100R5
ET5040DC-R5-06	-06	Truck and fuel 100R5
ET5040DC-R5-08	-08	Truck and fuel 100R5
ET5040DC-R5-10	-10	Truck and fuel 100R5
ET5040DC-R5-12	-12	Truck and fuel 100R5
ET5040DC-R5-16	-16	Truck and fuel 100R5
ET5040DC-R5-20	-20	Truck and fuel 100R5
ET5040DC-R5-24	-24	Truck and fuel 100R5
ET5040DC-R5-32	-32	Truck and fuel 100R5

**ET5070-002-230/ET5070-002-230KT\***  
**ET5070-002-380/ET5070-002-380KT\***  
**ET5070-002-400/ET5070-002-400KT\***  
**ET5070-002-420/ET5070-002-420KT\***  
**ET5070-002-440/ET5070-002-440KT\***  
**ET5070-002-460/ET5070-002-460KT\***  
**ET5070-002-480/ET5070-002-480KT\***

\*All KT part numbers come with the machine, calibration tooling, die installation tool, standard die package, adapter die package, double foot pedal and machine mounted storage rack

## Weatherhead

### Crimp machines

## ET5070

### Industrial production crimp machine



All pumps are included with machine purchase. To review machine and pump package options please refer to the following ordering options.

#### \*ET5040C-0001†

Adapter die package (Supplied with ET5070 crimp machines. Required for use with ET5040DC style dies and used to calibrate machine.)

#### \*ET5040C-0004

Die installation tool

#### ET5040C-0006

Automatic backstop

#### ET5040C-0007

Manual backstop

#### ET5050C-0009

Viewing mirror

#### \*ET5040C-0014

Machine mounted die storage rack (includes insert holders)

#### ET5040C-0016

Table top die storage rack (includes insert holders)

#### \*ET5040C-0019†

Calibration tool (supplied with ET5070 crimp machines)

#### \*ET5040C-0020

Double pedal foot switch

#### \*ET5040C-0023

Includes 11 of the most popular standard ET5040DC style die sets

#### ET5040DC-M320St

32mm die set

#### ET5040DC-MXXX

Standard die sets

#### ET5040PBL-MXXX

Large bore industrial hose die sets

#### ET4001C-0017

Magnetic work lamp

\*Components included in machine kit packages "KT"

†Calibration tooling (supplied with all ET5070 base machines)

Please note that ET5070 shares dies, crimp components, and some accessories with the ET5040 and ET5050

**Tooling can also be ordered a la carte.** Visit the Danfoss PowerSource Crimp Specs tool at [danfoss.com/crimp](http://danfoss.com/crimp) to find the tooling needed for all of the hoses and fittings you plan to crimp.

ET5070 ordering		
Select a machine kit	Kit includes	Pump included
<b>ET5070-002-230KT</b>	ET5070-001-230 machine, calibration tooling, die installation tool, standard die package, adapter die package, double foot pedal and machine mounted storage rack	230v 3 phase pump included
<b>ET5070-002-380KT</b>	ET5070-001-380 machine, calibration tooling, die installation tool, standard die package, adapter die package, double foot pedal and machine mounted storage rack	380v 3 phase pump included
<b>ET5070-002-400KT</b>	ET5070-001-400 machine, calibration tooling, die installation tool, standard die package, adapter die package, double foot pedal and machine mounted storage rack	400v 3 phase pump included
<b>ET5070-002-420KT</b>	ET5070-001-420 machine, calibration tooling, die installation tool, standard die package, adapter die package, double foot pedal and machine mounted storage rack	420v 3 phase pump included
<b>ET5070-002-440KT</b>	ET5070-001-440 machine, calibration tooling, die installation tool, standard die package, adapter die package, double foot pedal and machine mounted storage rack	440v 3 phase pump included
<b>ET5070-002-460KT</b>	ET5070-001-460 machine, calibration tooling, die installation tool, standard die package, adapter die package, double foot pedal and machine mounted storage rack	460v 3 phase pump included
<b>ET5070-002-480KT</b>	ET5070-001-480 machine, calibration tooling, die installation tool, standard die package, adapter die package, double foot pedal and machine mounted storage rack	480v 3 phase pump included



## Specialty tooling kit

The Danfoss tools listed are offered in kits for any given hose type, or collets and tools can be purchased individually by catalog number. Visit [www.weatherhead.com](#) to find the tooling needed for all of the hoses and fittings you plan to crimp.



### T-400-66

#### 069 'E' Series collet kit

This kit can be used with the following machines: T-420, ET4001, ET1000

Spacer Rings not included in T-400-66 kit.

Kit includes one of each of the following

Part #	Description
<b>T-400-54C</b>	Collet – 3/16"
<b>T-400-56C</b>	Collet – 5/16"
<b>T-400-57C</b>	Collet – 13/32"
<b>T-400-58C</b>	Collet – 1/2"
<b>T-400-59C</b>	Collet – 5/8"
<b>T-400-60C</b>	Collet – 7/8"
<b>T-400-61C</b>	Collet – 1-1/8"

### T-400-114

#### 757 "E" series collet kit

This kit can be used with the following systems: T-400-1, T-420-1, T-440-1, ET1000, ET4000, T-460, T-462, T-465, and T-480.

Spacer Rings not included in T-400-114 kit.

Kit includes one of each of the following

Part #	Description
<b>T-400-105C</b>	Collet – 5/16"
<b>T-400-107C</b>	Collet – 1/2"
<b>T-400-106C</b>	Collet – 13/32"
<b>T-400-108C</b>	Collet – 5/8"

### T-400-104

#### 338 "P" series collet kit

This kit can be used with the following systems: T-400-1, T-420-1, T-440-1, ET1000, ET4000, T-460, T-462, T-465, and T-480.

Spacer Rings not included in T-400-104 kit.

Kit includes one of each of the following

Part #	Description
<b>T-400-102C</b>	Collet – 3/8"
<b>T-400-103C</b>	Collet – 1/2"
<b>FS-2900</b>	Label set

### T-400-137

#### 229 "P" series collet kit

This kit can be used with the following systems: T-400-1, T-420-1, T-440-1, ET1000, ET4000, T-460, T-462, T-465, and T-480.

Spacer Rings not included in T-400-137 kit.

Kit includes one of each of the following

Part #	Description
<b>T-400-80C</b>	Collet – 3/16"
<b>T-400-82C</b>	Collet – 13/32"
<b>T-400-81C</b>	Collet – 5/16"
<b>T-400-83C</b>	Collet – 1/2"

## Weatherhead

### Repair and replacement items

General repair & replacement items	
Part #	Description
<b>T-400-G</b>	1.5 oz. Tube high efficiency PTFE grease
<b>FF91455</b>	16 oz. Can, high efficiency PTFE grease

ET1000 repair & replacement items	
Part #	Description
<b>ET1000C-0001</b>	Stand
<b>ET1000C-0006</b>	Pusher
<b>ET1000AR-001</b>	Adapter ring
<b>ET1000C-0021</b>	Wall mount bracket
<b>ET1000C-0012</b>	Pusher extension

ET4001 repair & replacement items	
Part #	Description
<b>ET4001C-0017</b>	Gooseneck lamp, magnetic mount
<b>T-410-1M</b>	Micro switch
<b>ET4000AR-001</b>	Base adapter ring
<b>ET4000AR-002</b>	Base adapter ring
<b>ET4000TP-0001</b>	Locator bracket kit
<b>ET4000TP-0002</b>	Wear plate kit
<b>ET4001C-0015</b>	Shroud
<b>120-00429</b>	Screw, hex head (8)
<b>FF91042</b>	Cart for ET4001 or T-420

T-420 repair & replacement items	
Part #	Description
<b>T-420-1M</b>	Micro-switch for T-420-1 press
<b>T-420-28</b>	Tool locator bracket
<b>T-420-B</b>	Tool locator bracket
<b>W-EQCR-TE006-E</b>	Shroud decal
<b>T-420-H</b>	Handle
<b>T-420-L</b>	Light bulb
<b>T-420-LA</b>	Light assembly
<b>T-420-LS</b>	Light switch
<b>AN436777624684n-000101</b>	Instructions for T-420-1
<b>T-420-P</b>	Pusher set (2) with wear plates and screws
<b>T-420-S</b>	Press shroud with decals
<b>T-420-26</b>	Insert – base plate
<b>T-420-G</b>	Linkage assembly
<b>T-420-2R</b>	Rack
<b>T-420-2K</b>	Pinion shaft assembly (incl'd T-420-2G, T-420-2R and T-420-2S)
<b>T-420-2S</b>	Replacement pinion gear shaft
<b>140-06745</b>	Pusher wear plates includes (1) left and (1) right
<b>140-06748</b>	Pusher wear plates screws (1)
<b>FF91042</b>	Cart for ET4001 or T-420

T-450/T-465 repair & replacement items	
Part #	Description
<b>T-450-D1</b>	Spacer ring selector decal for nylon hose (H009, H209, H243, H435, and H436)
<b>T-450-P</b>	Pusher
<b>T-450-Q</b>	Quick disconnect coupling
<b>T-450-K</b>	Pusher and retainer plate repair kit: Includes: T-450-B Pusher bolt (1) T-450-R Retainer plate (1) T-450-S Retainer plate screw (2)
<b>W-EQCR-TE011-E</b>	Shroud decal

T-464 repair & replacement items	
Part #	Description
<b>AP432452437325en-000101</b>	Instructions
<b>T-460-SPR</b>	Slide pull rod
<b>T-460-16</b>	Hose assembly
<b>T-460-2</b>	Hand pump
<b>W-EQCR-TE009-E</b>	Shroud decal
<b>T-460-P</b>	Pusher
<b>T-460-SF</b>	Slide flange
<b>T-460-SP</b>	Slide plate
<b>T-460-SPK</b>	Slide pull knob

T-466 repair & replacement items	
Part #	Description
<b>W-EQCR-TM008-E</b>	Instructions
<b>T-460-P</b>	Pusher
<b>T-460-SF</b>	Slide flange
<b>T-460-SP</b>	Slide plate
<b>W-EQCR-TE010-E</b>	Shroud decal
<b>140-06675</b>	Air regulator kit
<b>T-460-SPK</b>	Slide pull knob
<b>T-460-SPR</b>	Slide pull rod
<b>T-462-16</b>	Hose assembly
<b>T-462-V</b>	Regulator only
<b>T-462-2</b>	Air/hydraulic pump

See pages 286-289 for replacement pumps.

Reference page 283 for specialty tooling and collet kits. For individual tooling items, such as collets, spacer rings, machine bowls, and adapter rings, visit [www.danfoss.com](#) or contact Danfoss.

Refer to the applicable machine operator's manuals for safety information.

Additional repair and replacement items are available. Refer to the owner's manual or contact Danfoss for information.

T-480 portable crimp machine repair and replacement items

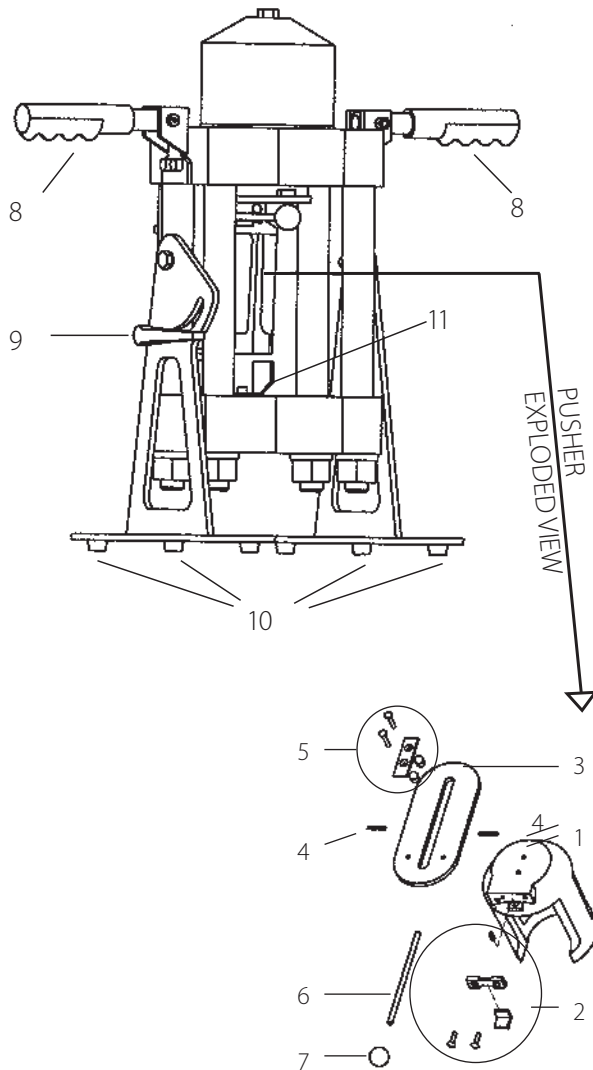

T-480 portable crimp machine repair & replacement items

#	Part #	Description
1	T-480-P	Pusher
2	T-480-PSK	Pusher stop repair kit (Includes pusher clip, 2 machine screws, pusher stop & spring)
3	T-480-SP	Slider plate
4	140-05485-01	Roll pin
5	T-480-SFK	Slide flange kit (Includes slide flange, 2 bushings and 2 machine screws)
6	T-480-SPR	Slide pull rod
7	T-480-SPK	Slide pull knob
8	140-06601	Vinyl grip
9	T-480-TBK	Tilt bracket knob
10	140-06894	Foot pad
11	T-480-69	Tool locator bracket
#	T-480-16	10,000 PSI replacement hose assembly for 480-HP
#	T-480-17	10,000 PSI replacement hose assembly for T-480-TA and T-480-EP
#	T-480-18	10,000 PSI replacement hose assembly for 480-AH
#	140-06906	Hydraulic quick coupler used with the T-480-TA and T-480-EP system
#	T-480-3	Turbo air/hydraulic replacement pump for T-480-TA system
#	T-481-110	Electric replacement pump for T-480-EP system
#	T-480-2	Hand replacement pump for T-480-HP system
#	T-482-2	Air/hydraulic replacement pump for T-480-AH system
#	W-EQCR-TE012-E	Shroud decal
#	BC425482205281en-000101	Set-up and operating guide for T-480 system

# Item not illustrated in parts breakdown.

T-400-1 crimp machine repair & replacement items

Part #	Description
T-400-B	Pusher bolt
T-400-BB	Switch to interface T400-1 crimper to T421U pump or T-421U-110 pump. Upgraded solid state relay can be purchased through Lomar. Part number 140-06761-SS.
T-400-G	1.5 oz. Tube high efficiency * grease
T-400-K1	Seal replacement kit for T-400-1 press
W-EQCR-TD003-E	Shroud decal
T-400-M	Instructions for T-400-1
T-400-S	Replacement press shroud with decals
T-400-8	Die ring
T-400-13	Replacement** collet cage for T-400 "U" Series collets, 1/4" and 3/8" sizes only, and 229 "P" series collets, all sizes, with a "C" suffix.
T-400-14	Replacement** collet cage for T-400 "U" Series collets with a "C" suffix, 1/2" through 1" only
T-400-19	60" Hose assembly and fittings
T-400-90	Replacement** collet cage for T-400 "E", 069 "E", and "E" Series collets with a "C" suffix.
T-432-15	Pusher

\*\* 2 required for each collet

## Weatherhead

Crimp machine power units

### T-403-2 Hand pump

For use with T-400-1.



- Dimensions :**  
7 high, 21" long, 4-3/4" wide
- Weight :**  
9 lbs.
- Operation pressure :**  
4000-4200 PSI
- Reservoir capacity:**  
1 qt.
- Outlet port size:**  
3/8"
- NPT hydraulic oil:**  
Use Enerpac oil ONLY

**Note:**  
For repair and replacement items for the following pumps please contact an Enerpac distributor at [www.enerpac.com](http://www.enerpac.com): T-402-2, T-403-2, T-481-110 & T-482-2.

### T-460-2 Hand pump

For use with T-450-1, T-460 and T-465.



- Dimensions:**  
5-5/8" High, 13-1/4" long,  
3-3/4" wide
- Weight:**  
4-1/2 lbs.
- Operation pressure :**  
0-10,000 PSI
- Reservoir capacity :**  
20 cu in.
- Relief valve setting :**  
10,000 PSI
- Hydraulic oil:**  
Use Enerpac oil ONLY

**Note:**  
For repair and replacement items for the following pumps please contact an Enerpac Distributor at [www.enerpac.com](http://www.enerpac.com): T-402-2, T-403-2, T-433, T-460-2, T-462-2, T-480-2, T-480-3, T-481-110 & T-482-2.

### T-480-2 Two-stage hand pump

For use with T-480-HP, ET1000.



- Dimensions:**  
7-3/16" high x 21-1/64" long x 4-3/4" wide
- Weight:**  
10 lbs.
- Operation pressure :**  
0-10,000 PSI
- Hydraulic oil :**  
Use Enerpac oil ONLY

#### Repair and replacement items for discontinued T-401-1 pump

Catalog #	Description
T-401-1BC	Breather cap for Fenner-Stone pumps
T-401-1S	Toggle switch
T-401-SVF	Shuttle valve for Fenner-Stone pump

## T-421U

### Electric pump (220 volt)

For use with T-400-1 and T-420-1.

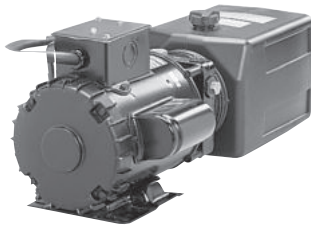

**Dimensions:** 7-1/2" high,  
22" long, 10" wide

**Weight :** 75 lbs.

**Operation pressure:**  
4000-4200 PSI

**Reservoir capacity:**  
6 quarts

**Outlet port size:**  
3/4"-16 Straight Thread

**Motor:** 1 H.P., 3450 R.P.M.,  
220 volts, 60 cycle, single phase  
At 50 Hertz, RPM = 2,850  
At 60 Hertz, RPM = 3,450

**T-421UCSA:** CSA approved

**Hydraulic oil\*:** ISO 32 hydraulic oil or (ATF)  
automatic transmission fluid

**Flow:** 2.5 GPM @ 750 PSI,  
0.5 GPM @ 4000 PSI

\*For low temperature applications automatic transmission fluid can be substituted.

#### Replacement parts:

Catalog #	Description
140-06761	Relay for T-421U, T-441 and T-441 pumps only
T-421U-BC	Breather cap - twist lock
T-421-FP	220v 4 wire female electrical receptacle
T-401-1BC	Breather cap - threaded

**Note:** It is recommended that the electric pump be used on a 15 amp. fused circuit. Pump wired for 220 volts, single phase.

## T-421U-110

### Electric pump (110 volt)

For use with T-400-1 and T-420-1.

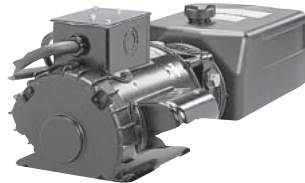

For dimensional data other than voltage information, refer to T-421U see above.

**T-421U-110CSA**  
CSA approved

**Note:** It is recommended that the electric pump be used on an individual 30 amp. fused circuit. Pump wired for 110 volts, single phase.

**Note:** Upgraded solid state relay can be purchased through Lomar, part #: 140-06761-SS.

## T-481-110

### Electric pump (110 volt)

For use with T-480-EP, ET1000 and ET1187.



**Dimensions:**  
14-14" High, 9-5/8" long, 9-5/8" wide

**Weight:**  
32 lbs.

**Operation pressure:**  
0-10,000 psi

**Hydraulic oil :**  
Use Enerpac oil ONLY

## ET4001P-002

### Electric pump (220 volt)

For use with ET4001 press.

It features a two-stage pump providing high flow at low pressure for fast ram approach and low flow at high pressure for actual crimping.

**Dimensions:** 7½" high,  
10" wide, 22" long

**Weight** 75 lbs.

**Operation pressure**  
5,000 psi

**Reservoir capacity** 6 quarts

**Outlet port size**  
¾-16 Straight thread O-Ring

**Motor** 1HP, 3450 RPM, 220 volts, 60 cycle, single phase

**Hydraulic oil** ISO 32  
(SAE 10W)

**Flow** 2.6 GPM to 900 psi.  
0.6 GPM above 900 psi

**!** The ET4001P-002 electric pump has the relief valve set at 5,000 psi. Damage to the press will result and the warranty may be voided if higher pressures are used. Requires individual 20 amp service breaker (220 v).

## Weatherhead

Crimp machine power units

### T-441 Electric pump (220 volt)

For use with T-440-1 and ET4000 only.

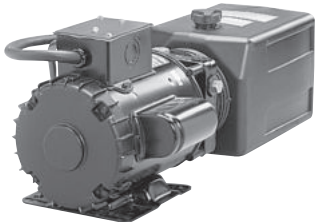

The T-441 power unit features a two-stage pump providing high flow at low pressure for a fast ram approach and low flow at high pressure for actual crimping.

**Dimensions:** 7-1/2" high, 22" long, 10" wide

**Weight:** 75 lbs.

**Operation pressure:** 5,000 PSI

**Reservoir capacity:** 6 quarts

**Outlet port size :** 3/4-16 Straight thread O-Ring

**Motor:** 1 H.P., 3450 R.P.M., 220 volts, 60 cycle, single phase

**Hydraulic oil:** ISO 32 hydraulic oil automatic transmission fluid

**Flow:** 2.5 GPM @ 750 PSI, 0.5 GPM @ 5000 PSI

#### Replacement parts:

Catalog #	Description
T-421U-BC	Breather cap
T-421-FP	220v 4 wire female electrical receptacle
140-06761	Relay for T-421U or T-421U-110 pumps

**Note:** T-441 pump is to be used with the T440-1 and ET4000 press only. When replacing the pump on a standard T-410 press (without the black switchbox on the side of the press) refer to the repair and replacement items on page 284.

### T-402-2 Air/hydraulic pump

For use with T-400-1.



**Dimensions :** 5-1/4" high, 12-1/2" long, 5" wide

**Weight:** 18 lbs.

**Operation pressure:** 4000-4200 PSI

**Reservoir capacity:** 606 ml.

**Hydraulic oil:** Use Enerpac oil ONLY

**Outlet port size:** 3/8" NPT

**Inlet (air) port size :** 1/4" NPT

**Inlet air pressure required :** 60 to 120 PSI

**Note:** It is recommended that a filter, regulator, lubricator, and air pressure gauge be installed in the air line as close as possible to the pump. Filter, regulator, and lubricator units not included.

Some models have air port on right side.

### T-482-2 Air/hydraulic pump

For use with T-480-AH, ET1000.

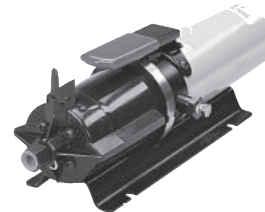

**Dimensions:** 5" High, 14-5/8" long, 5-5/8" wide

**Weight:** 12 lbs.

**Operation pressure :** 0-10,000 psi

**Hydraulic oil:** Use Enerpac oil ONLY

**T-462-2**  
Air/hydraulic pump

For use with T-462.

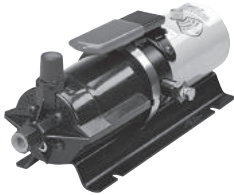

The T-462-2 power unit is a air/hydraulic pump designed for use with the T-462 portable system. Ideal if you have the availability of compressed air in your shop or in the field via a portable compressor.

**Dimensions :**  
4" high, 13" long

**Weight:**  
8 lbs.

**Operation pressure:**  
0-10,000 PSI

**Reservoir capacity :**  
10 cu in.

**Relief valve setting :**  
10,000 PSI

**Hydraulic oil :**  
Use Enerpac oil ONLY

Regulator to be set for  
100-120 PSI inlet air

**T-480-3**  
Turbo air/  
hydraulic pump

For use with T-480-TA.



**Dimensions:**  
8-1/4"High x 12-3/8" long x  
8" wide

**Weight:**  
16-1/2 lbs.

**Operation pressure:**  
0-10,000 PSI

**Hydraulic oil:**  
Use Enerpac oil ONLY

For repair and replacement items for the following pumps please contact an Enerpac Distributor at [www.enerpac.com](http://www.enerpac.com): T-402-2, T-403-2, T-460-2, T-462-2, T-480-2, T-480-3, T-481-110 & T-482-2.

**T-421-FP**  
4-Prong female  
electrical outlet



All 220v pumps are equipped with a four prong electrical outlet as illustrated.

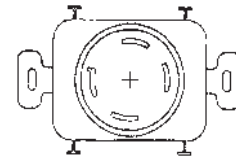

To obtain corresponding female wall receptacle order T-421-FP. For use with T-421U, T-441 and T-433 pumps.

Competitor conversion kits

**T-420-GT****Gates PC707  
conversion kit**

The T-420-GT conversion kit is designed to allow the use of standard Danfoss tooling, hose, and hose ends in the Gates PC707 crimper. Everything is included to convert the crimper to accept Danfoss tooling. This kit gives the crimper capacity to crimp up to and including 1-1/4" I.D. 4 wire spiral hose factory-type hose assemblies.

- Shroud
- Adapter ring
- (2) Locater pins
- ET425SR-015D spacer ring
- Assembly Instructions

**T-400-MK****Parker Minikrimp  
conversion kit**

The T-400-MK conversion kit is designed to allow the use of standard Danfoss tooling, hose, and hose ends in the Parker Minikrimp crimper. Everything is included to convert the crimper to accept Danfoss tooling. This kit gives the crimper capacity to crimp up to and including 5/8" I.D. 2 wire braided and 5/8" I.D. 4 wire spiral factory-type hose assemblies.

For installation, simply remove the pusher, snap ring, spring, and die cage separator from the crimper. Then, insert the adapter bowl and reinstall the pusher.

Capabilities and crimp specs are based on the Danfoss T-400 machine, but please note that a spacer ring is required for every crimp. The included ET313SR-FLAT-CLR spacer ring should be used.

- ET313AR-PK adapter bowl
- ET313SR-FLAT-CLR spacer ring
- Grease
- Vinyl wrap to cover shroud
- Danfoss decal
- Instruction sheet
- Caution decal
- Serial number decal
- Core hose crimp chart
- FF91761 Rust-oleum Gloss Charcoal Gray Spray Paint

**T-420-KK****Parker Karrykrimp  
conversion kit**

The T-420-KK conversion kit is designed to allow the use of standard Danfoss tooling, hose, and hose ends in the Parker Karrykrimp 1 and Karrykrimp 2 crimpers. Everything is included to convert the crimper to accept Danfoss tooling. This kit gives the crimper capacity to crimp up to and including 1" I.D. braided hose and 5/8" I.D. 4 wire spiral hose for the Karrykrimp 1 and up to and including 1 1/4" I.D. 4 wire spiral hose for the Karrykrimp 2.

- ET425AR-PK
- (2) 2-1/2" roll pins
- ET1000C-0012 spacer ring
- Grease
- Vinyl wrap to cover shroud
- Danfoss decal
- Caution decal
- Serial number decal
- Core hose crimp chart
- Assembly instructions
- FF91761 Rust-oleum Gloss Charcoal Gray Spray Paint



Refer to the applicable machine operator's manuals for safety information.



## T-420-PK

Parker Parkrimp  
conversion kit



The T-420-PK conversion kit is designed to allow the use of standard Danfoss tooling, hose, and hose ends in the Parker Parkrimp 1 crimper. Everything is included to convert the crimper to accept Danfoss tooling. This kit gives the crimper capacity to crimp up to and including 1" I.D. braided hose and 5/8" I.D. 4 wire spiral hose.

- ET425AR-PK
- ET1000C-0012 Spacer
- Grease Tube
- Vinyl Wrap
- Danfoss Decal
- Instruction Sheet
- Caution Decal
- Serial Number Decal
- Core Hose Crimp Chart
- Spacer Dowels
- Right Cam Ramp
- Left Cam Ramp
- FF91761 Rust-oleum Gloss Charcoal Gray Spray Paint

**Weatherhead**

Reusable fitting accessories

**FT1038A**

PTFE hose tool



Smooth bore PTFE Hose,  
-03, -04, -05, -06, -08, -10 and -12

- Small
- Hand held tool

FT1038A PTFE hose tool  
(-03 thru -12)

FT1038B PTFE hose tool  
(-16, -20)

**F2015**

**SOCKETLESS** fitting bench  
mounted assembly machine



SOCKETLESS hose, all sizes

- Fast, hand assembly
- Bench mounted
- Hose is securely held
- Mandrels included

F2015 Complete machine

## T-101A

Barb-Tite™ end assembly tool



Assembly of Barb-Tite push-on hose ends is made easy with this handy tool. Easy and fast operation assures dependable, leak proof assemblies. Simply clamp hose in jaws, place hose end on push rod and pull the handle. Engineered for a lifetime of rugged service.

1 lb.

1/4" to 1/2" I.D. hose only.

## T-201

Barb-Tite end assembly tool



This bench-mounted tool is actually two tools in one. Not only does it assemble Barb-Tite hose ends, it is also a hose cutter. To cut your hose, simply retract the handle, place the hose in the cutter area and pull the handle. After cutting the hose to the desired length, place the hose under the cam handle locking it in place with the hose end aligned with the appropriate mark on the label. Place the barbed end of the fitting against the end of the hose and then pull the handle forward to complete the installation. The T-201 assembly tool is an easy-to-use tool that does everything you need to create a hose assembly.

Note: This tool is designed to cut fiber-reinforced rubber hose only.

1/4" to 3/4" I.D. hose

## Weatherhead

Reusable fitting and hose cutting accessories

### FT1081 PTFE hose assembly tool kit

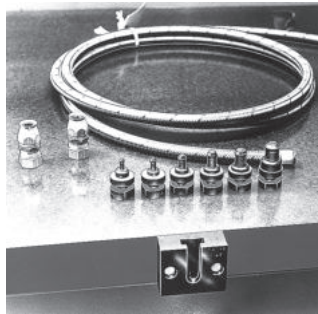

Smooth bore PTFE hose, -03, -04, -05, -06, -08, -10 and -12 hose. FT1090-3-10-4 and FT1090-3-10-5 are useful wire flare tools to use in conjunction with kit FT1081.

- Inexpensive
- Easy to use
- Seats PTFE tube against sleeve

FT1081 Complete tool kit

**Includes:**

FT1081-3-1	Mandrel holder
FT1081-3-2-3	Mandrel -3 hose
FT1081-3-2-4	Mandrel -4 hose
FT1081-3-3-5	Mandrel -5 hose
FT1081-3-4-6	Mandrel -6 hose
FT1081-3-5-8	Mandrel -8 hose
FT1081-3-6-10	Mandrel -10 hose
FT1081-3-7-12	Mandrel -12 hose
FT1081-16	Mandrel -16 hose
FT1081-20	Mandrel -20 hose

### 4523-04006 Hand-held hose cutter



Handy tool for cutting Danfoss Synflex hose 1/8-inch to 1/2-inch in diameter. Blades are replaceable. Vinyl cushioned grips

Part #: 4523-04005

### 4523-04007 Bench top cutter



The 4523-04007 bench top cutter is ideal for production of thermoplastic and other fabric reinforced hose style assemblies.

### 222070 Assembly lube, one pint



Specially compounded petroleum based hose assembly lubricant.

Part #: 222070-8

### 4574-01000 Twin-line hose separation tool



Designed for separating Twin-Line hose

Part #: 4574-02000

## 4573-00000

Multi-line hose separation tool



Designed for separation of tri-, quad- and five-line hose

Part #: 4523-04005

## T-191

Plastic tube and hose cutter

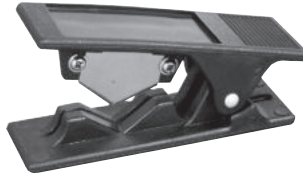

Only 2-7/8" long, the versatile T-191 offers quick and clean square cuts on 1/16" to 1/2" O.D. plastic tubing and non-wire reinforced hose. The T-191 can be either bench or wall mounted and offers the safety of closing automatically when not in use.

Part #: T-191B  
(one per package)

## FT1341

Thread measuring kit



Measuring tube and pipe fitting threads can be a most difficult task if not completely understood. Tools needed include a thread pitch gauge, calipers and seat angle gauges. To aid you, Danfoss has a kit to fit your needs; the FT1341 thread measuring kit.

- Thread pitch gauge (Imperial and metric)
- Inside/outside caliper (inches and millimeters)
- 2 seat angle gauges (37°/45° and a 12°/30°)
- How to identify fluid ports and connectors bulletin
- Carrying case for easy and convenient storage

Weight: .5 lb.

## T-135

Plastic tube and hose cutter



An economical alternative to quality tube and hose cutting. This versatile tool is lightweight and durable for long service life.

T-135B

Up to 1" hose I.D.

**Note:** Not for use with wire-reinforced hose

## FF12139

EZ Clip™ System



The EZ Clip™ System is designed for assembly with EverCool™ multi-refrigerant hose GH001. It's engineered connection exceeds SAE J2064 and has been vibration and impulse tested.

Note: The EZ Clip System has been designed to work exclusively with EverCool GH001 Hose.

### Kit contents components

Part #	Description	Qty
<b>1F40104-size</b>	Clips	20 each size
<b>1F40105-size</b>	Cages	10 each size
<b>FT1357</b>	Assy. tool	1
<b>T-135</b>	Hose cutter	1
<b>T-135B</b>	Replacement blade	1

## **Weatherhead**

---



Weatherhead by Danfoss

## Hose prep



## Weatherhead

Hose saws

# ET9000, ET9100, ET9200 & ET9300 series

Hose saws

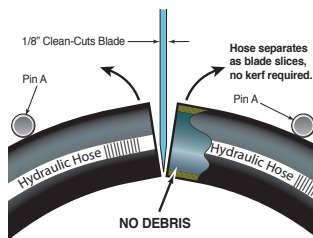
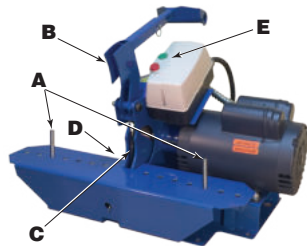

ET9100/200/300 hydraulic hose cutting system is break-through technology using a toothed blade, cutting with the backs of each tooth, so the blade does not take a kerf. The saw bends the hose into the blade spreading the cut edges to avoid burning and smoking.

With the ET9100/200/300 hydraulic hose saws the hose is positioned across two pins (A) and moved into the blade (C) by a feed foot (B) using a pulldown handle for better leverage on heavy hose. The feed motion causes the

hose to stretch at the point of contact with the blade, allowing it to separate as it is cut (see image at right). This separation allows the hose to pass clear of the saw blade with NO friction, NO heating and NO DEBRIS! A vacuum hose (not shown) is attached to a vacuum port (D) to remove any tiny amount of debris or smoke during cutting. Improved safety using a 110V on/off switch (E) with a magnetic contactor. When power is lost, the saw will not turn back on independently. Comes with advanced scalloped blade.

### WARNING

The user must exercise extreme care when operating any Danfoss assembly equipment with powered moving components. Safety glasses must be worn at all times when using any Danfoss assembly equipment.

Read and understand the owners and operators manual before attempting to operate any equipment.

Danfoss personnel are available to answer any questions, please call:

**Danfoss,**  
14615 Lone Oak Road,  
Eden Prairie, MN 55344,  
952-937-9800.

Danfoss assembly equipment is designed to be used only with Danfoss hose and Danfoss hose fittings.

## ET9000 series



### ET9000 series saw

Model	Motor	4-1/2" inch Blade	Cutting capacity
<b>ET9000-45-110</b>	1 HP, 115 VAC (1 Phase), 60 Cycle, 7.5 amp, 11,000 RPM	4-1/2" OD x 0.070 THK x 5/8" arbor	3/4" ID x 2 wire braid hydraulic hose

\* Requires 15 Amp Circuit †Canadian Standards Association Rated

\* ET9000 saws ship with micro-slotted blade.

### ET9000 series saw blade

Model	Type	Blade	Cutting capacity
<b>ET9000C-45-MS</b>	Micro-slotted blade	4-1/2" OD x 0.070 THK x 5/8" arbor	3/4" ID x 2 wire braid hydraulic hose



## ET9100 series



### ET9100 series saws

Model	Motor	7 inch Blade	Cutting capacity
<b>ET9100-07-110</b>	1-1/2 HP, 110 VAC (1 Phase), 60 Cycle, 17** Amp, 3,430 RPM	7" OD x .093 THK x 3/4" arbor	1-1/4" ID x 4 wire hydraulic hose
<b>ET9100-07-110CSA†</b>	1-1/2 HP, 110 VAC (1 Phase), 60 Cycle, 17** Amp, 3,430 RPM	7" OD x .093 THK x 3/4" arbor	1-1/4" ID x 4 wire hydraulic hose
<b>ET9100-07-22060</b>	2 HP, 220 VAC (1 Phase), 60 Cycle, 11* Amp, 3,430 RPM	7" OD x .093 THK x 3/4" arbor	1-1/4" ID x 4 wire hydraulic hose
<b>ET9100-07-22050</b>	2 HP, 220 VAC (1 Phase), 50 Cycle, 11* Amp, 2,865 RPM	7" OD x .093 THK x 3/4" arbor	1-1/4" ID x 4 wire hydraulic hose

\* Requires 15 Amp Circuit \*\* Requires 20 Amp Circuit †Canadian Standards Association Rated

\* ET9100 saws ship with advanced scalloped blade.

\* Requires 15 Amp Circuit \*\* Requires 20 Amp Circuit †Canadian Standards Association Rated

\* ET9000 saws ship with micro-slotted blade.

### ET9100 series saw blades

Model	Type	Blade	Cutting capacity
<b>ET9100C-07-AS</b>	Advanced scalloped blade	7" OD x .093 THK x 3/4" arbor	1-1/4" ID x 4 wire hydraulic hose
<b>ET9100C-07-MS</b>	Micro-slotted blade	7" OD x .093 THK x 3/4" arbor	1-1/4" ID x 4 wire hydraulic hose
<b>ET9100C-07-SM</b>	Smooth blade	7" OD x .093 THK x 3/4" arbor	1-1/4" ID x 4 wire hydraulic hose
<b>ET9100C-07-SC</b>	Scalloped blade	7" OD x .093 THK x 3/4" arbor	1-1/4" ID x 4 wire hydraulic hose
<b>ET9100C-07-SL</b>	Slotted blade	7" OD x .093 THK x 3/4" arbor	1-1/4" ID x 4 wire hydraulic hose

Hose saws

## ET9200 series



ET9200 series saws			
Model	Motor	10 inch Blade	Cutting capacity
<b>ET9200-10-220</b>	5 HP, 220 VAC (1 Phase), 60 Cycle, 21 Amp, 3,490 RPM	10" OD x .125 THK x 40 mm	2" ID x 6 wire hydraulic hose ‡
<b>ET9200-10-22050</b>	3 HP, 220 VAC (1 Phase), 50 Cycle, 4 Amp, 2,865 RPM	10" OD x .125 THK x 40 mm	2" ID x 6 wire hydraulic hose ‡
<b>ET9200-10-220 CSA †</b>	5 HP, 220 VAC (1 Phase), 60 Cycle, 21 Amp, 3,490 RPM	10" OD x .125 THK x 40 mm	2" ID x 6 wire hydraulic hose ‡
<b>ET9200-10-220-3</b>	3 HP, 220 VAC (3 Phase), 60 Cycle, 11* Amp, 3,490 RPM	10" OD x .125 THK x 40 mm	2" ID x 6 wire hydraulic hose ‡
<b>ET9200-10-220-3 CSA †</b>	3 HP, 220 VAC (3 Phase), 60 Cycle, 11* Amp, 3,490 RPM	10" OD x .125 THK x 40 mm	2" ID x 6 wire hydraulic hose ‡
<b>ET9200-10-440-3</b>	3 HP, 440 VAC (3 Phase), 60 Cycle, 4 Amp, 3,490 RPM	10" OD x .125 THK x 40 mm	2" ID x 6 wire hydraulic hose ‡
<b>ET9200-10-12V</b>	4 HP, 12 VDC, 10,000 RPM	10" OD x .125 THK x 40 mm	2" ID x 4 wire hydraulic hose
<b>ET9200-10-24V</b>	4 HP, 24 VDC, 10,000 RPM	10" OD x .125 THK x 40 mm	2" ID x 4 wire multi-spiral hydraulic hose

\* Requires 15 Amp Circuit \*\* Requires 20 Amp Circuit † ET9200 saws ship with advanced scalloped blade.

‡Canadian Standards Association Rated † Diamond Blade Recommended for Frequent 6 Wire Cutting

ET9200 series saw blades			
Model	Type	10 inch Blade	Cutting capacity
<b>ET9200C-10-AS</b>	Advanced scalloped blade	10" OD x .125 THK X 40 mm arbor	2" ID x 6 wire hydraulic hose ‡
<b>ET9200C-10-MS</b>	Micro-slotted blade	10" OD x .125 THK X 40 mm arbor	2" ID x 6 wire hydraulic hose ‡
<b>ET9200C-10-D</b>	Diamond blade	10" OD x .125 THK X 40 mm arbor	2" ID x 6 wire hydraulic hose ‡
<b>ET9200C-10-SM</b>	Smooth blade	10" OD x .125 THK X 40 mm arbor	2" ID x 6 wire hydraulic hose ‡
<b>ET9200C-10-SC</b>	Scalloped blade	10" OD x .125 THK X 40 mm arbor	2" ID x 6 wire hydraulic hose ‡
<b>ET9200C-10-SL</b>	Slotted blade	10" OD x .125 THK X 40 mm arbor	2" ID x 6 wire hydraulic hose ‡

## ET9300 series



### ET9300 series saws

Model	Motor	14 inch Blade	Cutting capacity
<b>ET9300-14-220</b>	5 HP, 220 VAC (1 Phase), 60 Cycle, 21 Amp, 3,490 RPM	14" OD x .160 THK X 40 mm	2" ID x 6 wire hydraulic hose ‡ and 5" OD spiral wound hose
<b>ET9300-14-22050</b>	3 HP, 220 VAC (1 Phase), 50 Cycle, 11* amp, 3,490 RPM	14" OD x .160 THK X 40 mm	2" ID x 6 wire hydraulic hose ‡ and 5" OD spiral wound hose
<b>ET9300-14-220-3</b>	3 HP, 220 VAC (3 Phase), 60 Cycle, 11* Amp, 3,490 RPM	14" OD x .160 THK X 40 mm	2" ID x 6 wire hydraulic hose ‡ and 5" OD spiral wound hose
<b>ET9300-14-440-3</b>	3 HP, 440 VAC (3 Phase), 60 Cycle, 4 Amp, 3,490 RPM	14" OD x .160 THK X 40 mm	2" ID x 6 wire hydraulic hose ‡ And 5" OD spiral wound hose
<b>ET9300-14-220-3 CSA †</b>	3 HP, 220 VAC (3 Phase), 60 Cycle, 11* Amp, 3,490 RPM	14" OD x .160 THK X 40 mm	2" ID x 6 wire hydraulic hose ‡ and 5" OD spiral wound hose

\* Requires 15 Amp Circuit \*\* Requires 20 Amp Circuit \* ET9300 saws ship with advanced scalloped blade.

† Canadian Standards Association Rated ‡ Diamond Blade Recommended for Frequent 6 Wire Cutting

### ET9300 series saw blades

Model	Type	Blade size	Cutting capacity
<b>ET9300C-14-AS</b>	Advanced scalloped blade	14" OD x .160 THK X 40 mm arbor	2" ID x 6 wire hydraulic hose 5" OD spiral wound hose
<b>ET9300C-14-MS</b>	Micro-slotted blade	14" OD x .160 THK X 40 mm arbor	2" ID x 6 wire hydraulic hose 5" OD spiral wound hose
<b>ET9300C-14-D</b>	Diamond blade	14" OD x .160 THK X 40 mm arbor	2" ID x 6 wire hydraulic hose 5" OD spiral wound hose
<b>ET9300C-14-SM</b>	Smooth blade	14" OD x .160 THK X 40 mm arbor	2" ID x 6 wire hydraulic hose 5" OD spiral wound hose
<b>ET9300C-14-SC</b>	Scalloped blade	14" OD x .160 THK X 40 mm arbor	2" ID x 6 wire hydraulic hose 5" OD spiral wound hose
<b>ET9300C-14-SL</b>	Slotted blade	14" OD x .160 THK X 40 mm arbor	2" ID x 6 wire hydraulic hose 5" OD spiral wound hose

# Weatherhead

## Hose saw blades

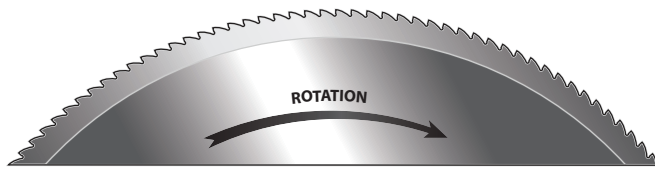

Features advanced performance scalloped knife technology for cutting hydraulic spiral hose and wire helix hose resulting in cleaner cuts, faster cuts, no smoke, and longer blade life. Available in 6" to 14" sizes to fit Weatherhead®, Clean-Cuts™, Custom Crimp®, Gates®, Goodyear®, Imperial Eastman®, Parker®, Stratoflex®, Toledo®, and Weatherhead® saws.

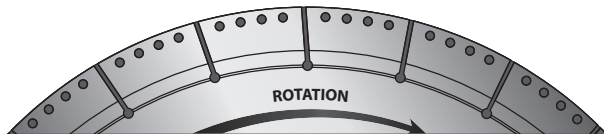

Exclusively designed for cutting heavy 4 and 6 wire hydraulic hoses. This diamond grinding technology cuts down by 60% the debris while cutting heavy hoses very quickly as opposed to using abrasive wheels. You will get a fantastic finish and make 5 – 10 second cuts in 2" hose.



Smooth edge knife designed for the best finish when cutting light duty hoses like single wire braid, textile reinforced, poly or nylon reinforced, and Teflon® fluoropolymer® resin hoses.

Available in sizes 7"-14" to fit Weatherhead®, Clean-Cuts™, Custom Crimp®, Gates®, Goodyear®, Hydrosand®, Imperial Eastman®, O+P®, Parker®, Savage Stone®, Stratoflex®, Toledo®, and Weatherhead®.

Advanced scalloped blade				
Model	Diameter	Thickness	Arbor	Danfoss saw
ET9500C-06-AS	6"	0.093"	5/8"	-
ET9500C-07-AS	7"	0.093"	5/8"	-
ET9100C-07-AS	7"	0.093"	3/4"	ET9100
ET9500C-08-AS	8"	0.093"	5/8"	-
ET9500C-10-AS	10"	0.093"	3/4"	-
ET9500C-10-1-AS	10"	0.125"	1"	-
ET9200C-10-AS	10"	0.125"	40mm	ET9200
ET9500C-12-AS	12"	0.125"	1"	-
ET9500C-14-AS	14"	0.125"	1"	-
ET9300C-14-AS	14"	0.160"	40mm	ET9300

Diamond hydraulic hose blade				
Model	Diameter	Thickness	Arbor	Danfoss saw
ET9200C-10-D	10"	0.125"	40mm	ET9200
ET9300C-14-D	14"	0.160"	40mm	ET9300

Smooth beveled edge hydraulic hose blade				
Model	Diameter	Thickness	Arbor	Danfoss saw
ET9500C-07-SM	7"	0.093"	5/8"	-
ET9100C-07-SM	7"	0.093"	3/4"	ET9100
ET9500C-08-SM	8"	0.093"	5/8"	-
ET9500C-10-SM	10"	0.062"	5/8"	-
ET9500C-10-1-SM	10"	0.093"	3/4"	-
ET9200-10-1-SM	10"	0.093"	40mm	ET9200
ET9500C-10-2-SM	10"	0.125"	1"	-
ET9200C-10-SM	10"	0.125"	40mm	-
ET9500C-12-SM	12"	0.093"	1"	-
ET9500C-12-1-SM	12"	0.125"	1"	-
ET9500C-14-SM	14"	0.125"	1"	-
ET9300C-14-SM	14"	0.160"	40mm	ET9300
ET9500C-16-SM	16"	0.160"	1"	-
ET9500C-18-SM	18"	0.160"	1"	-
ET9500C-20-SM	20"	0.160"	1"	-
ET9500C-22-SM	22"	0.160"	1"	-
ET9500C-24-SM	24"	0.160"	1"	-
ET9500C-26-SM	26"	0.160"	1"	-

Teflon is a trademark of The Chemours Company FC, LLC used under license by Danfoss.

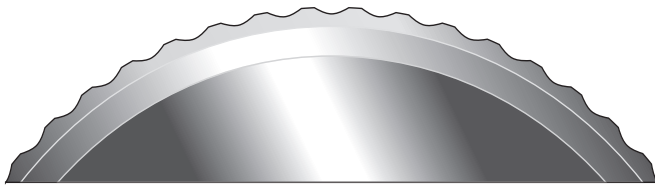

Notched scalloped knives are designed for rough duty cutting on spiral hose up to 6 wire.

Available in sizes 7"-14" to fit Weatherhead®, Clean-Cuts™, Custom Crimp®, Gates®, Goodyear®, Hydroscand®, Imperial Eastman®, O+P®, Parker®, Savage®, Stone®, Stratoflex®, Toledo®, and Weatherhead®.

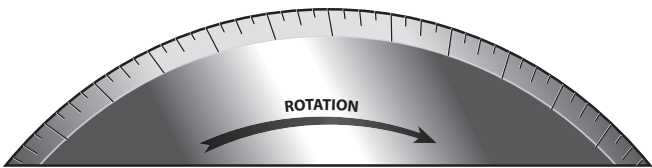

Features "new" micro-slotted smooth edge knife technology combining the better finishes of a double bevel knife with the more aggressive performance of a slotted knife. This is our most universal knife grind and will give you two times longer blade life than smooth edge knives. Used for cutting spiral hose, industrial hose, Teflon, PTFE, Kevlar, and metal hose.

Available in 6" to 14" sizes to fit Weatherhead®, Clean-Cuts™, Custom Crimp®, Gates®, Goodyear®, Imperial Eastman®, Parker®, Stratoflex®, Toledo®, and Weatherhead® saws.

Also available in 16" to 26" sizes to fit Hydroscand®, Finn Power®, Marken®, O+P®, Savage®, Stone®, Techmaflex® and Uniflex® saws.

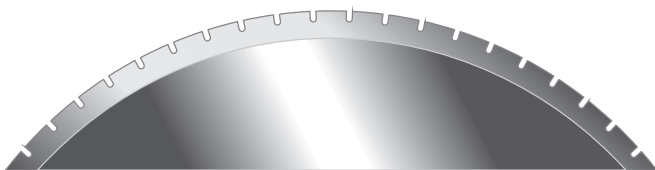

Designed for cutting 4 to 6 wire spiral hoses, this high performance heavy duty slotted knife reduces pinching by skiving the sides of the hose while cutting.

Available in 7" to 14" sizes to fit Weatherhead®, Clean-Cuts™, Custom Crimp®, Gates®, Goodyear®, Imperial Eastman®, Parker®, Stratoflex®, Toledo®, and Weatherhead® saws.

Available in sizes 16" to 36" to fit on Finn Power®, Hydroscand®, Marken®, O+P®, Savage®, Stone®, Stratoflex®, Techmaflex® and Uniflex® saws.

**Notched scalloped hydraulic hose blade**

Model	Diameter	Thickness	Arbor	Danfoss saw
ET9500C-07-SC	7"	0.093"	5/8"	-
ET9100C-07-SC	7"	0.093"	3/4"	ET9100
ET9500C-08-SC	8"	0.093"	5/8"	-
ET9500C-10-SC	10"	0.093"	3/4"	-
ET9500C-10-1-SC	10"	0.125"	1"	-
ET9200C-10-SC	10"	0.125"	40mm	ET9200
ET9500C-12-SC	12"	0.125"	1"	-
ET9500C-14-SC	14"	0.125"	1"	-

**Micro-slotted smooth edge hydraulic hose blade**

Model	Diameter	Thickness	Arbor	Danfoss saw
ET9000C-45-MS	4.5"	0.070"	5/8"	ET9000
ET9500C-06-MS	6"	0.093"	5/8"	-
ET9500C-07-MS	7"	0.093"	5/8"	-
ET9100C-07-MS	7"	0.093"	3/4"	ET9100
ET9500C-08-MS	8"	0.093"	5/8"	-
ET9500C-10-MS	10"	0.062"	5/8"	-
ET9500C-10-1-MS	10"	0.093"	3/4"	-
ET9200C-10-1-MS	10"	0.093"	40mm	ET9200
ET9500C-10-2-MS	10"	0.125"	1"	-
ET9200C-10-MS	10"	0.125"	40mm	ET9200
ET9500C-12-MS	12"	0.093"	1"	-
ET9500C-12-1-MS	12"	0.125"	1"	-
ET9500C-14-MS	14"	0.125"	1"	-
ET9300C-14-MS	14"	0.160"	40mm	ET9300
ET9500C-16-MS	16"	0.160"	1"	-
ET9500C-18-MS	18"	0.160"	1"	-
ET9500C-20-MS	20"	0.160"	1"	-
ET9500C-22-MS	22"	0.160"	1"	-
ET9500C-24-MS	24"	0.160"	1"	-
ET9500C-26-MS	26"	0.160"	1"	-

**Slotted smooth hydraulic hose blade**

Model	Diameter	Thickness	Arbor	Danfoss saw
ET9500C-07-SL	7"	0.093"	5/8"	-
ET9100C-07-SL	7"	0.093"	3/4"	ET9100
ET9500C-08-SL	8"	0.093"	5/8"	-
ET9500C-10-SL	10"	0.062"	5/8"	-
ET9500C-10-1-SL	10"	0.093"	3/4"	-
ET9200C-10-1-SL	10"	0.093"	40mm	ET9200
ET9500C-10-2-SL	10"	0.125"	3/4"	-
ET9500C-10-3-SL	10"	0.125"	1"	-
ET9200C-10-SL	10"	0.125"	40mm	ET9200
ET9500C-12-SL	12"	0.093"	1"	-
ET9500C-12-1-SL	14"	0.125"	1"	-
ET9500C-14-SL	14"	0.125"	1"	-
ET9300C-14-SL	14"	0.160"	40mm	ET9300
ET9500C-16-SL	16"	0.160"	1"	-
ET9500C-18-SL	18"	0.160"	1"	-
ET9500C-20-SL	20"	0.160"	1"	-
ET9500C-20-1-SL	20"	0.160"	40mm	-
ET9500C-21-SL	21"	0.160"	38mm	-
ET9500C-22-SL	22"	0.160"	50mm	-
ET9500C-24-SL	24"	0.160"	1"	-
ET9500C-26-SL	26"	0.160"	1"	-

# Weatherhead

Hose proof test stands

## FT1312 Hose proof test stand



Assemblies up to 2" I.D.,  
6 spiral wire

- Designed to use tap water, eliminating the need for a special test fluid
- Compact power unit is air driven
- Air regulator and gauge provide easy pressure adjustment and monitoring
- Tough transparent Lexan\* lid
- 79" x 36" x 53", 550 lbs

The power unit of the FT1312 tester is a compact, economical air driven hydraulic pump. It will provide sufficient hydraulic pressure to proof test any Weatherhead hose assembly, up to 22,000 psi

\*Lexan is a General Electric trademark.

## FT1261 Hose proof test stand



Assemblies up to 2" I.D.,  
6 spiral wire in  
50 ft. coil lengths

- Designed to use tap water, eliminating the need for a special test fluid
- Air regulator and gauge provide easy pressure adjustment and monitoring
- Tough transparent Lexan\* lid
- 96" x 84" x 54", 800 lbs

The power unit of the FT1261 tester is a compact, economical air driven hydraulic pump. It will provide sufficient hydraulic pressure to proof test any Weatherhead hose assembly, up to 22,000 psi

\*Lexan is a General Electric trademark.

FT1312 and FT1261 Standard adapter selection chart

Hose fitting* style and size	Fitting adapter part #	Pressure port adapter part #	Plug or cap part #
SAE 37°(JIC) swivel			
-4	2027-8-4S	**	900599-4
-5	2021-6-5S	2081-12-6S	900599-5
-6	2027-8-6S	**	900599-6
-8	2027-8-8S	**	900599-8
-10	2027-10-08S	**	900599-10
-12	2027-08-12S	**	900599-12
-16	2021-12-16S	**	900599-16
-20	2021-16-20S	2040-12-16S	900599-20
-24	2021-16-24S	2040-12-16S	900599-24
-32	2021-16-32S	2040-12-16S	900599-32
SAE 45° swivel			
-4	2000-06-4B	2081-12-6S	900599-4
-5	2000-06-5B	2081-12-6S	900599-5
-6	2000-06-6B	2081-12-6S	2001-6-6B, 2082-6S
-8	2000-12-8B	**	900599-8
-10	2000-12-10B	**	900599-10
-12	2000-12-12B	**	2001-8-12B, 2082-8S

\*Two adapters are required per hose assembly to be tested.

### Male pipe

-2	2081-08-02S	2081-12-08S	2046-2-2S, 2082-2S
-4	2081-08-04S	2081-12-08S	2046-4-4S, 2082-4S
-6	2081-08-06S	2081-12-08S	2046-6-6S, 2082-6S
-8	2081-08-08S	**	2046-8-8S, 2082-8S
-12		**	2046-12-12S, 2082-12S
-16	2040-12-16S	**	2046-16-16S, 2082-16S
-20	2040-16-20S	2040-12-16S	2046-20-20S, 2082-20S
-24	2040-20-24S	2040-12-16S, 2040-16-20S	2046-24-24S, 2082-24S
-32	2040-24-32S	2040-12-16S, 2040-16-20S, 2040-20-24S	2046-32-32S, 2082-32S

\*Two adapters are required per hose assembly to be tested.

\*\*Internal Skive fittings only.

# FT1058

## Hose proof test stand



- Pressure gauge
- Release valve
- Hand hydraulic pump
- Foot switch
- Fluid reservoir, use SAE 5 wt. hydraulic oil (oil not included)
- Electric fluid pump
- Safety lid
- Pressure port (3/4-14 NPTF Female Port)
- 42" x 22" x 9" (41" with legs), 75 lbs
- 10,000 psi maximum proof pressure

110V 60 Hz, single phase motor

FT1058 as shown above. Legs can be removed for bench mounting.

### FT1058 Adapter selection chart

Hose fitting* style and size	Fitting adapter part #	Pressure port adapter part #	Plug or cap part #
<b>SAE 37°(JIC) swivel</b>			
-4	2021-6-4S	2081-12-6S	900599-4
-5	2021-6-5S	2081-12-6S	900599-5
-6	2021-12-6S	-	900599-6
-8	2021-12-8S	-	900599-8
-10	2021-12-10S	-	900599-10
-12	2021-12-12S	-	900599-12
-16	2021-12-16S	-	900599-16
-20	2021-16-20S	2040-12-16S	900599-20
-24	2021-16-24S	2040-12-16S	900599-24
-32	2021-16-32S	2040-12-16S	900599-32
<b>SAE 45° swivel</b>			
-4	2000-06-04B	2081-12-6S	900599-4
-5	2000-06-05B	2081-12-6S	900599-5
-6	2000-06-06B	2081-12-6S	2001-6-6B, 2082-6S
-8	2000-12-08B	-	900599-8
-10	2000-12-10B	-	900599-10
-12	2000-12-12B	-	2001-8-12B, 2082-8S
<b>Male pipe</b>			
-2	2081-8-2S	2081-12-8S	2046-1-2S, 2082-2S
-4	2081-8-4S	2081-12-8S	2046-4-4S, 2082-4S
-6	2081-8-6S	2081-12-8S	2046-6-6S, 2082-6S
-8	2081-12-8S	-	2046-8-8S, 2082-8S
-12		-	2046-12-12S, 2082-12S
-16	2040-12-16S	-	2046-16-16S, 2082-16S
-20	2040-16-20S	2040-12-16S	2046-20-20S, 2082-20S
-24	2040-20-24S	2040-12-16S, 2040-16-20S	2046-24-24S, 2082-24S
-32	2040-24-32S	2040-12-16S, 2040-16-20S, 2040-20-24S	2046-32-32S, 2082-32S

\*Adapters are available for other hose fitting styles. Contact Danfoss.

# Weatherhead

Contamination control

## FT1455 series

Projectile cleaning system



FT1455 Series is focused on eliminating contamination in hydraulic systems. Contamination control is crucial during the preparation processes in assembling fittings on hose, tubes, and pipes. These systems shoot the FT1355 Series cleaning projectiles through hose, tubes, and pipe assemblies to successfully remove rubber dust and metal particles arising from the hydraulic hose cutting process, remove metal flashings from the hose assembly process (crimping), and remove contaminated oil from hoses, tubes and pipes prior to installation in hydraulics systems.

- Provides industry leading ISO cleanliness levels
- Simple and robust construction
- Available in hand-held and bench-mount configurations
- Ideal for portable small volume applications, and large volume production applications
- Broad variety of projectile and nozzle types and sizes to match application needs
- Minimal setup, works off shop air (80–110 psi)
- Capability: 1/8" to 4 1/2" ID hose, tube or pipe
- Available in kits or individual replacement hardware components
- Kits available with and without projectiles

### Typical applications

<b>Hydraulics</b>	<ul style="list-style-type: none"> <li>• Removes rubber dust and metal particles from the hydraulic hose cutting process</li> <li>• Removes metal flash from the crimping process on hose and tubes</li> <li>• Removal of contaminated oil from hoses, tubes and pipes in hydraulic systems</li> </ul>
<b>Pneumatics</b>	<ul style="list-style-type: none"> <li>• Eliminates rubber contamination, metal particles, contaminated oil and moisture that causes breakdowns and inefficiency</li> </ul>
<b>Heat exchangers &amp; condenser</b>	<ul style="list-style-type: none"> <li>• Eliminates contamination that reduces heat transfer resulting in low level performance</li> </ul>
<b>Steam boilers</b>	<ul style="list-style-type: none"> <li>• Removes most scaling in steam pipes for maintenance servicing</li> </ul>
<b>Air conditioning &amp; refrigeration</b>	<ul style="list-style-type: none"> <li>• Eliminates minute particles in copper tubes and coolant lines that affect system performance</li> </ul>
<b>Oxygen &amp; gas</b>	<ul style="list-style-type: none"> <li>• Eliminates oil, grease and other contaminants from copper or S/S tubing</li> </ul>
<b>Oil, gas &amp; chemical processing</b>	<ul style="list-style-type: none"> <li>• Efficient cleaning of pipes as part of service maintenance</li> </ul>
<b>Earthmoving equipment</b>	<ul style="list-style-type: none"> <li>• Maintenance reduction in flushing time and filter usage</li> </ul>
<b>Automotive &amp; servicing</b>	<ul style="list-style-type: none"> <li>• Cleaning of fuel lines and brake lines prior to assembly and servicing of components</li> </ul>
<b>Food &amp; beverage</b>	<ul style="list-style-type: none"> <li>• Product recovery retrieval of product from lines. Reducing or eliminating solvents or detergents</li> </ul>
<b>Gun barrels</b>	<ul style="list-style-type: none"> <li>• To remove rust, scale or powder residue much faster than brushing or swabbing</li> </ul>



## FT1455 series

### Hardware



### FT1455-L1

#### Hand held projectile cleaning hardware for small hose diameters (up to 1-1/4" hose ID)

- Capability – For use with 1/8" through 1-1/4" ID hose, tube or pipe assemblies
- Construction – Simple construction with durable brass and aluminum parts with rigid plastic handle
- Form factor – Hand-held, portable - ideal for mobile applications
- Typical applications: small volume hose shop environments
- Includes hand-held launcher hardware only. Does not include adapter rings and nozzles for operation. Intended for replacement purposes only



### FT1455-L2

#### Hand held projectile cleaning hardware for medium hose diameters (up to 2" hose ID)

- Capability – For use with 1/8" through 2" ID hose, tube or pipe assemblies
- Construction - Precision machined aluminum with fully anodized components
- Form factor – Hand-held, portable – ideal for harsh environments and heavy use
- Typical applications: Production hose and tube shops, mobile hose fabricators and mobile applications
- Includes hand-held launcher hardware only. Does not include adapter rings and nozzles for operation. Intended for replacement purposes only



### FT1455-L3

#### Hand held projectile cleaning hardware for large hose diameters (up to 3-1/2" hose ID)\*

- Capability – For use with 1/8" through 3-1/2" ID hose, tube or pipe assemblies
- Construction - Precision machined aluminum with fully anodized components
- Form factor – Hand-held, portable – ideal for harsh environments and heavy use
- Typical applications: Production hose and tube shops, mobile hose fabricators and mobile applications
- Includes hand-held launcher hardware only. Does not include adapter rings and nozzles for operation. Intended for replacement purposes only



### FT1455-L4

#### Bench mount projectile cleaning hardware kit for small hose diameters (up to 1-1/4" hose ID)\*

- Capability – For use with 1/8" through 1-1/4" ID hose, tube or pipe assemblies
- Construction – Stainless steel housing with anodized aluminum components
- Form factor – Bench mount – ideal for production assemblies (1.2 second cycle time)
- Typical applications: Production hose and tube shops
- Includes bench mount launcher hardware, 5 micron air filter, pneumatic foot switch and twin line air hose and 7 nozzles for hose ID ranging from 1/4" through 1-1/4"

**NOTE:** For proper operation the following are required:

- 80 psi (5.5 Bar) minimum to 110 psi (7.5 Bar) maximum air pressure
- 1/2" ID air hose with a minimum of 55 SCFM (1.6 m<sup>3</sup>/min) air flow rate†
- 5 micron air filter and regulator with gauge are strongly suggested
- A large industrial compressor is strongly recommended
- A compressed air dryer is strongly recommended

†A minimum of 38 SCFM (1.1 m<sup>3</sup>/min) air flow rate at 80 psi (5.5 bar) is required for FT1455-L3 launcher  
\*FT1455-L3 can be converted to work on hose ID up to 4" with the addition of FT1455-N-45 4-1/2" aluminum locking nozzle.

Contamination control

## FT1455 series

### Projectile cleaning system kit



### FT1455-K1

**Hand held projectile cleaning kit**  
for small hose diameters (up to 1-1/4" hose ID)

Capability – For use with 1/4" through 1-1/4" ID hose, tube or pipe assemblies  
Construction – Simple construction with durable brass and aluminum parts with rigid plastic handle

Form factor – Hand-held, portable – ideal for mobile applications  
Typical applications – small volume hose shop environments



### FT1455-K2

**Hand held projectile cleaning starter kit**  
for small hose diameters (up to 1-1/4" hose ID)

Capability – For use with 1/4" through 1-1/4" ID hose, tube or pipe assemblies  
Construction – Simple construction with durable brass and aluminum parts with rigid plastic handle

Form factor – Hand-held, portable – ideal for mobile applications  
Typical applications – small volume hose shop environments.  
Catch can not included



### FT1455-K3

**Hand held projectile cleaning kit**  
for medium hose diameters (up to 2" hose ID)

Capability – For use with 1/4" through 2" ID hose, tube or pipe assemblies  
Construction – Precision machined aluminum with fully anodized components

Form factor – Hand-held, portable – ideal for harsh environments and heavy use  
Typical applications – Production hose and tube shops, mobile hose fabricators and mobile applications



### FT1455-K4

**Hand held projectile cleaning kit**  
for medium hose diameters (up to 2" hose ID)

Capability – For use with 1/8" through 2" ID hose, tube or pipe assemblies  
Construction – Precision machined aluminum with fully anodized components

Form factor – Hand-held, portable – ideal for harsh environments and heavy use  
Typical applications – Production hose and tube shops, mobile hose fabricators and mobile applications



### FT1455-K5

**Hand held projectile cleaning kit**  
for large hose diameters (up to 3-1/2" hose ID)

Capability – For use with 1/8" through 4-1/2" hose, tube or pipe assemblies  
Construction – Precision machined aluminum with fully anodized components

Form factor – Hand-held, portable – ideal for harsh environments and heavy use  
Typical applications – Production hose and tube shops, mobile hose fabricators and mobile applications

## FT1455 series

### Cleaning nozzles



### FT1455-N-HXX

#### Nozzles for hose assemblies

- Universal nozzle for use with hoses
- Also work on pipe, heavy walled tubing and many fitting configurations



### FT1455-J-XX

#### Nozzles for hose assemblies with JIC fittings

- Nozzles molded with 37° male flare on tip to fit female JIC fittings on hose assemblies

Broad variety of nozzles are available allowing the operator to select the ideal nozzle for each application based on the different size and type of hoses, hose fittings, tube and pipe assemblies. All nozzle sizes are denoted by the projectile exit diameter (mm).

#### FT1455-N-HXX nozzles

Part #	Description
<b>FT1455-N-HXX</b>	Nozzles for hose assemblies
<b>FT1455-N-H06</b>	Hose nozzle (1/4")
<b>FT1455-N-H08</b>	Hose nozzle (5/16")
<b>FT1455-N-H10</b>	Hose nozzle (3/8")
<b>FT1455-N-H13</b>	Hose nozzle (1/2")
<b>FT1455-N-H16</b>	Hose nozzle (5/8")
<b>FT1455-N-H19</b>	Hose nozzle (3/4")
<b>FT1455-N-H25</b>	Hose nozzle (1")
<b>FT1455-N-H32</b>	Hose nozzle (1-1/4")
<b>FT1455-N-H38</b>	Hose nozzle (1-1/2")
<b>FT1455-N-H50</b>	Hose nozzle (2")
<b>FT1455-N-U55</b>	Universal hose nozzle (1-1/8" thru 3-1/2")
<b>FT1455-N-45</b>	4-1/2" aluminum locking nozzle

#### FT1455-J-XX nozzles

FT1455-J-XX	Nozzles for tube assemblies (Metric) Outside diameter X wall thickness
<b>FT1455-J-06</b>	JIC nozzle (4-1/2")
<b>FT1455-J-10</b>	JIC nozzle (4-1/2")
<b>FT1455-J-13</b>	JIC/TUBE nozzle (-8, 1/2")
<b>FT1455-J-16</b>	JIC/TUBE nozzle (-10, 5/8")
<b>FT1455-J-19</b>	JIC/TUBE nozzle (-12, 3/4")
<b>FT1455-J-25</b>	JIC/TUBE nozzle (-16, 1" & 7/8")
<b>FT1455-J-32</b>	JIC/TUBE nozzle (-20, 1-1/4" & 1")
<b>FT1455-J-38</b>	JIC/TUBE nozzle (-24, 1-1/2")
<b>FT1455-J-50</b>	JIC/TUBE nozzle (-32, 2")

# Weatherhead

Contamination control

## FT1455 series (cont.)

### Cleaning nozzles



### FT1455-NT-XX

Nozzles for tube assemblies (Inch)

- Nominal inch tube nozzles have a lip on the inside that forms an airtight seal when tube is fully inserted into the nozzle

Broad variety of nozzles are available allowing the operator to select the ideal nozzle for each application based on the different size and type of hoses, hose fittings, tube and pipe assemblies. All nozzle sizes are denoted by the projectile exit diameter (mm).

FT1455-NT-XX nozzles	
FT1455-NT-XX	Nozzles for tube assemblies (Inch)
<b>FT1455-NT-32</b>	TUBE nozzle 1-1/4" OD
<b>FT1455-NT-06</b>	TUBE nozzle 1/4" OD
<b>FT1455-NT-03</b>	TUBE nozzle 1/8" OD
<b>FT1455-NT-10</b>	TUBE nozzle 3/8" OD
<b>FT1455-NT-08</b>	TUBE nozzle 5/16" OD



### FT1455-NT-XXXXX

Nozzles for tube assemblies (Metric)

- Metric tube nozzles have a lip on the inside that forms an airtight seal when tube is fully inserted into the nozzle
- Metric tube nozzle designations utilize the largest wall thickness for a given outside diameter, but fit all smaller wall thicknesses as well

FT1455-NT-XXXXX nozzles	
FT1455-NT-XX	Nozzles for tube assemblies (Metric) Outside diameter X wall thickness
<b>FT1455-NT-06x1.5</b>	Metric tube nozzle UC-6 X 1.5
<b>FT1455-NT-08x1.5</b>	Metric tube nozzle UC-8 X 1.5
<b>FT1455-NT-10x1.5</b>	Metric tube nozzle UC-10 X 1.5
<b>FT1455-NT-12x2.0</b>	Metric tube nozzle UC-12 X 2.0
<b>FT1455-NT-14x2.0</b>	Metric tube nozzle UC-14 X 2.0
<b>FT1455-NT-15x2.0</b>	Metric tube nozzle UC-15 X 2.0
<b>FT1455-NT-16x2.5</b>	Metric tube nozzle UC-16 X 2.5
<b>FT1455-NT-18x2.5</b>	Metric tube nozzle UC-18 X 2.5
<b>FT1455-NT-20x3.0</b>	Metric tube nozzle UC-20 X 3.0
<b>FT1455-NT-22x2.0</b>	Metric tube nozzle UC-22 X 2.0
<b>FT1455-NT-25x3.0</b>	Metric tube nozzle UC-25 X 3.0
<b>FT1455-NT-28x2.5</b>	Metric tube nozzle UC-28 X 2.5
<b>FT1455-NT-30x4.0</b>	Metric tube nozzle UC-30 X 4.0
<b>FT1455-NT-35x3.0</b>	Metric tube nozzle UC-35 X 3.0
<b>FT1455-NT-38x5.0</b>	Metric tube nozzle UC-38 X 5.0
<b>FT1455-NT-42x3.0</b>	Metric tube nozzle UC-42 X 3.0
<b>FT1455-NT-50x5.0</b>	Metric tube nozzle UC-50 X 5.0
<b>FT1455-4FFORX</b>	Nozzle for use with flat face O-Ring seal fittings (FORS)

## FT1455 series

### Adapter & locking rings



### FT1455-L2-AR1

#### Adapter ring

Adapter ring for FT1455-L2 launcher to receive 1/8" thru 1-1/4" nozzles

- FT1455-L2-AR1 adapter ring fits the FT1455-L2 hand held launcher and all nozzle types and sizes between 1/8" and 1-1/4"



### FT1455-L3-AR2

#### Adapter ring

Adapter ring for FT1455-L3 launcher to receive 1/8" thru 1-1/4" nozzles

- FT1455-L3-AR2 adapter ring fits the FT1455-L3 hand held launcher and all nozzle types and sizes between 1/8" and 1-1/4"



### FT1455-L3-LR

#### Locking ring

3-1/2" aluminum locking ring for FT1455-L3 launcher FT1455-L3-LR locking ring fits

- FT1455-L3 hand held launcher, both FT1455-L3-AR2 & FT1455-L3-AR3 adapter rings, and FT1455-N-U55 Universal hose nozzle



### FT1455-L3-AR3

#### Adapter ring

Adapter ring for FT1455-L3 launcher to receive 1-1/2" thru 2" nozzles

- FT1455-L3-AR3 adapter ring fits the FT1455-L3 hand held launcher and all nozzle types and sizes between 1-1/2" and 2".

**Weatherhead**

Contamination control

**FT1455 series**

Accessories

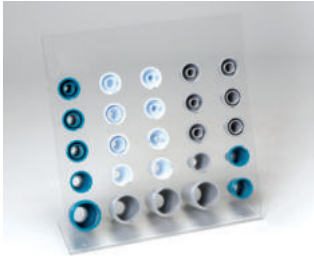

**FT1455-NH25**

Desktop nozzle holder

- The desktop nozzle holder is a great alternative to storing the nozzles in the carrying case
- Can be easily attached to the workbench and offers easy access during change overs and operation
- Accommodates all types of nozzles ranging from 1/4" to 2"



**FT1455-QC**

Quick release coupling

- Quick release coupling offers a quick disconnect and exchange of air supply to all three models of hand held projectile launchers
- Ideal for portable applications that require frequent disconnects



**FT1455-CC**

Carrying case

- Convenient carrying case to store and carry the hand held projectile launchers and relevant nozzles
- Works will all 3 models of hand held projectile launchers

**FT1455 operating instructions**

Manuals

**FT1455-L1**

Operators Manual

Doc #: AQ445452721726en-000101

**FT1455-L3**

Operators Manual

Doc #: AQ445452770728en-000101

**FT1455-L2**

Operators Manual

Doc #: AQ445452746727en-000101

**FT1455-L4**

Operators Manual

Doc #: AQ445452791729en-000101

## FT1455 & FT1355 series

### Recommended nozzles and cleaning projectiles for hoses and hose assemblies

#### Recommendations for hoses: nominal hose diameter

Inches	mm	Nozzle part #	Cleaning projectile part#
3/16	05	FT1455-N-H06	FT1355-H-06 -
1/4	06	FT1455-N-H06	FT1355-H-10 or FT1355-H-12
5/16	08	FT1455-N-H08	FT1355-H-12 or FT1355-H-14
3/8	10	FT1455-N-H10	FT1355-H-14 or FT1355-H-16
1/2	13	FT1455-N-H13	FT1355-H-18 or FT1355-H-20
5/8	16	FT1455-N-H16	FT1355-H-22 -
3/4	19	FT1455-N-H19	FT1355-H-26 -
1	25	FT1455-N-H25	FT1355-H-33 or FT1355-H-36
1-1/4	32	FT1455-N-H32	FT1355-H-40 or FT1355-H-45
1-1/2	38	FT1455-N-H38	FT1355-H-50 or FT1355-H-55
2	50	FT1455-N-H50	FT1355-H-60 or FT1355-H-65
2-1/2	63	FT1455-N-U55	FT1355-H-75 -
3	76	FT1455-N-U55	FT1355-H-85 -
3-1/2	89	FT1455-N-U55	FT1355-H-100 -
4	102	FT1455-N-45	- -
4-1/2	114	FT1455-N-45	- -

#### Recommendations for hose assemblies with ORS fittings

ORS fitting dash size	Nozzle part #	Cleaning projectile part #
-4	FT1455-4FFORX	FT1355-H-06 or FT1355-H-07
-6	FT1455-N-H06	FT1355-H-12 -
-8	FT1455-N-H10	FT1355-H-16 -
-10	FT1455-N-H13	FT1355-H-22 -
-12	FT1455-N-H16	FT1355-H-26 -
-16	FT1455-N-H19	FT1355-H-33 -
-20	FT1455-N-H25	FT1355-H-40 -

#### Recommendations for hose assemblies with Code 61 or 62 flanges

Code 61 or 62 flange dash size	Nozzle part #	Cleaning projectile part #
-8	FT1455-N-H10	FT1355-H-16
-10	FT1455-N-H13	FT1355-H-22
-12	FT1455-N-H16	FT1355-H-26
-16	FT1455-N-H19	FT1355-H-33
-20	FT1455-N-H25	FT1355-H-40
-24	FT1455-N-H32	FT1355-H-50
-32	FT1455-N-H32	FT1355-H-60

#### Recommendations for hose assemblies with JIC fittings

JIC fitting dash size	Nozzle part #	Cleaning projectile part #
-4	FT1455-J-06	FT1355-H-06 or FT1355-H-07
-6	FT1455-J-10	FT1355-H-12
-8	FT1455-J-13	FT1355-H-16
-10	FT1455-J-16	FT1355-H-22
-12	FT1455-J-19	FT1355-H-26
-16	FT1455-J-25	FT1355-H-33
-20	FT1455-J-32	FT1355-H-40
-24	FT1455-J-38	FT1355-H-50
-32	FT1455-J-50	FT1355-H-60

Contamination control

## FT1455 & FT1355 series

Recommended nozzles and cleaning projectiles for pipes and tubes

### Recommended nozzles and cleaning projectiles for pipes (inch)

SCH 40	Nozzle part #	Cleaning projectile part #	Abrasive projectile part #
1/4"	FT1455-N-H08	FT1355-H-14	FT1355-A-12
3/8"	FT1455-N-H13	FT1355-H-18	FT1355-A-16
1/2"	FT1455-N-H16	FT1355-H-20	FT1355-A-18
3/4"	FT1455-N-H19	FT1355-H-30	FT1355-A-26
1	FT1455-N-H25	FT1355-H-36	FT1355-A-33
1-1/4"	FT1455-N-H32	FT1355-H-45	FT1355-A-40
1-1/2"	FT1455-N-H38	FT1355-H-55	FT1355-A-50
2"	FT1455-N-H50	FT1355-H-65	-
2-1/2"	FT1455-N-U55	FT1355-H-75	-
3"	FT1455-N-U55	FT1355-H-85	-
3-1/2"	FT1455-N-U55	FT1355-H-100	-

SCH 80	Nozzle part #	Cleaning projectile part #	Abrasive projectile part #
1/4"	FT1455-N-H06	FT1355-H-12	FT1355-A-10
3/8"	FT1455-N-H10	FT1355-H-16	FT1355-A-14
1/2"	FT1455-N-H13	FT1355-H-20	FT1355-A-16 or FT1355-A-18
3/4"	FT1455-N-H19	FT1355-H-26	FT1355-A-22
1"	FT1455-N-H25	FT1355-H-36	FT1355-A-30
1-1/4"	FT1455-N-H32	FT1355-H-45	FT1355-A-40
1-1/2"	FT1455-N-H38	FT1355-H-50	FT1355-A-45
2"	FT1455-N-H38	FT1355-H-60	FT1355-A-55
2-1/2"	FT1455-N-H50	FT1355-H-70	-
3"	FT1455-N-U55	FT1355-H-85	-
3-1/2"	FT1455-N-U55	FT1355-H-100	-

SCH 160	Nozzle part #	Cleaning projectile part #	Abrasive projectile part #
1/2"	FT1455-N-H10	FT1355-H-16	FT1355-A-14
3/4"	FT1455-N-H16	FT1355-H-20	FT1355-A-18
1"	FT1455-N-H19	FT1355-H-30	FT1355-A-26
1-1/4"	FT1455-N-H25	FT1355-H-36	FT1355-A-33
1-1/2"	FT1455-N-H32	FT1355-H-45	FT1355-A-40
2"	FT1455-N-H38	FT1355-H-55	FT1355-A-45 or FT1355-A-50
2-1/2"	FT1455-N-H50	FT1355-H-65	FT1355-A-60
3"	FT1455-N-U55	FT1355-H-75	-
4"	FT1455-N-U55	FT1355-H-100	-

### Recommended nozzles and cleaning projectiles for tubes (inch)

Outside diameter x wall thickness	Nozzle part #	Cleaning projectile part #	Abrasive projectile part #	Tube projectile part #
1/8" X 0.030"	FT1455-NT-3	-	-	-
1/4" X 0.035"	FT1455-NT-6	FT1355-H-10	FT1355-A-07	FT1355-T-06
1/4" X 0.049"	FT1455-NT-6	FT1355-H-08	FT1355-A-07	FT1355-T-06
1/4" X 0.065"	FT1455-NT-6	FT1355-H-07	-	FT1355-T-06
5/16" X 0.035"	FT1455-NT-8	FT1355-H-12	FT1355-A-10	FT1355-T-07
3/8" X 0.035"-0.049"	FT1455-NT-10	FT1355-H-14	FT1355-A-12	FT1355-T-10
3/8" X 0.065"	FT1455-NT-10	FT1355-H-12	FT1355-A-10	FT1355-T-10
1/2" X 0.035"	FT1455-J-13	FT1355-H-16	FT1355-A-16	FT1355-T-14
1/2" X 0.049"	FT1455-J-13	FT1355-H-16	FT1355-A-16	FT1355-T-12
1/2" X 0.065"	FT1455-J-13	FT1355-H-16	FT1355-A-14	FT1355-T-12
1/2" X 0.083"	FT1455-J-13	FT1355-H-14	FT1355-A-12	FT1355-T-12
5/8" X 0.049"	FT1455-J-16	FT1355-H-22	FT1355-A-20	FT1355-T-16
5/8" X 0.065"	FT1455-J-16	FT1355-H-20	FT1355-A-18	FT1355-T-16
5/8" X 0.083"	FT1455-J-16	FT1355-H-20	FT1355-A-18	FT1355-T-14
3/4" X 0.049"-0.065"	FT1455-J-19	FT1355-H-26	FT1355-A-24	FT1355-T-20
3/4" X 0.095"	FT1455-J-19	FT1355-H-22	FT1355-A-20	FT1355-T-18
7/8" X 0.049"	FT1455-J-25	FT1355-H-33	FT1355-A-30	FT1355-T-26
7/8" X 0.065"	FT1455-J-25	FT1355-H-30	FT1355-A-28	FT1355-T-22
7/8" X 0.095"	FT1455-N-H16	FT1355-H-28	FT1355-A-26	FT1355-T-22
1" X 0.065"	FT1455-J-32	FT1355-H-33	FT1355-A-30	FT1355-T-28
1" X 0.083"-0.095"	FT1455-J-32	FT1355-H-33	FT1355-A-30	FT1355-T-26
1" X 0.120"	FT1455-J-32	FT1355-H-30	FT1355-A-28	FT1355-T-26
1 1/4" X 0.065"	FT1455-NT-32	FT1355-H-40	FT1355-A-40	FT1355-T-33
1 1/4" X 0.083"	FT1455-NT-32	FT1355-H-40	FT1355-A-36	FT1355-T-33
1 1/4" X 0.095"	FT1455-NT-32	FT1355-H-40	FT1355-A-36	FT1355-T-33
1 1/4" X 0.109"	FT1455-NT-32	FT1355-H-36	FT1355-A-36	FT1355-T-33
1 1/4" X 0.120"	FT1455-NT-32	FT1355-H-36	FT1355-A-33	FT1355-T-33
1 1/2" X 0.065"-0.120"	FT1455-J-38	FT1355-H-50	FT1355-A-45	FT1355-T-40
1 1/2" X 0.134"-0.148"	FT1455-J-38	FT1355-H-45	FT1355-A-40	FT1355-T-40
2" X 0.065"-0.120"	FT1455-J-50	FT1355-H-60	FT1355-A-55	FT1355-T-50
2" X 0.134"-0.188"	FT1455-J-50	FT1355-H-55	FT1355-A-50	FT1355-T-50



## FT1455 & FT1355 series

### Recommended nozzles and cleaning projectiles for tubes (metric)

Nozzles & cleaning projectiles for tubes				
Outside diameter x wall thickness	Nozzle part #	Cleaning projectile part #	Abrasive projectile part #	Tube projectile part #
6 X 1.0	FT1455-NT-06x1.5	FT1355-H-07	FT1355-A-06	FT1355-T-06
6 X 1.5	FT1455-NT-06x1.5	FT1355-H-07	FT1355-A-06	-
8 X 1.0	FT1455-NT-08x1.5	FT1355-H-10	FT1355-A-07	FT1355-T-07
8 X 1.5	FT1455-NT-08x1.5	FT1355-H-10	FT1355-A-07	FT1355-T-07
10 X 1.0	FT1455-NT-10x1.5	FT1355-H-14	FT1355-A-12	FT1355-T-12
10 X 1.5	FT1455-NT-10x1.5	FT1355-H-14	FT1355-A-12	FT1355-T-12
12 X 1.0	FT1455-NT-12x2.0	FT1355-H-16	FT1355-A-14	FT1355-T-14
12 X 1.5	FT1455-NT-12x2.0	FT1355-H-16	FT1355-A-14	FT1355-T-14
12 X 2.0	FT1455-NT-12x2.0	FT1355-H-14	FT1355-A-12	FT1355-T-12
14 X 1.0	FT1455-NT-14x2.0	FT1355-H-18	FT1355-A-16	FT1355-T-16
14 X 1.5	FT1455-NT-14x2.0	FT1355-H-16	FT1355-A-14	FT1355-T-14
14 X 2.0	FT1455-NT-14x2.0	FT1355-H-16	FT1355-A-14	FT1355-T-14
15 X 1.0	FT1455-NT-15x2.0	FT1355-H-20	FT1355-A-18	FT1355-T-16
15 X 1.5	FT1455-NT-15x2.0	FT1355-H-18	FT1355-A-16	FT1355-T-16
15 X 2.0	FT1455-NT-15x2.0	FT1355-H-16	FT1355-A-14	FT1355-T-14
16 X 1.0	FT1455-NT-16x2.5	FT1355-H-22	FT1355-A-20	FT1355-T-18
16 X 1.5	FT1455-NT-16x2.5	FT1355-H-20	FT1355-A-18	FT1355-T-16
16 X 2.0	FT1455-NT-16x2.5	FT1355-H-18	FT1355-A-16	FT1355-T-16
16 X 2.5	FT1455-NT-16x2.5	FT1355-H-16	FT1355-A-14	FT1355-T-14
18 X 1.0	FT1455-NT-18x2.5	FT1355-H-24	FT1355-A-22	FT1355-T-20
18 X 1.5	FT1455-NT-18x2.5	FT1355-H-24	FT1355-A-20	FT1355-T-18
18 X 2.0	FT1455-NT-18x2.5	FT1355-H-22	FT1355-A-20	FT1355-T-18
18 X 2.5	FT1455-NT-18x2.5	FT1355-H-20	FT1355-A-18	FT1355-T-16
20 X 1.5	FT1455-NT-20x3.0	FT1355-H-26	FT1355-A-24	FT1355-T-22
20 X 2.0	FT1455-NT-20x3.0	FT1355-H-24	FT1355-A-22	FT1355-T-20
20 X 2.5	FT1455-NT-20x3.0	FT1355-H-24	FT1355-A-20	FT1355-T-18
20 X 3	FT1455-NT-20x3.0	FT1355-H-22	FT1355-A-20	FT1355-T-18

Nozzles & cleaning projectiles for tubes				
Outside diameter x wall thickness	Nozzle part #	Cleaning projectile part #	Abrasive projectile part #	Tube projectile part #
22 X 1	FT1455-NT-22x2.0	FT1355-H-30	FT1355-A-28	FT1355-T-26
22 X 1.5	FT1455-NT-22x2.0	FT1355-H-30	FT1355-A-28	FT1355-T-26
22 X 2	FT1455-NT-22x2.0	FT1355-H-30	FT1355-A-28	FT1355-T-26
25 X 2	FT1455-NT-25x3.0	FT1355-H-33	FT1355-A-30	FT1355-T-28
25 X 2.5	FT1455-NT-25x3.0	FT1355-H-30	FT1355-A-28	FT1355-T-26
25 X 3	FT1455-NT-25x3.0	FT1355-H-30	FT1355-A-28	FT1355-T-26
28 X 2	FT1455-NT-28x2.5	FT1355-H-36	FT1355-A-33	FT1355-T-33
28 X 2.5	FT1455-NT-28x2.5	FT1355-H-36	FT1355-A-33	FT1355-T-30
30 X 2	FT1455-NT-30x4.0	FT1355-H-36	FT1355-A-33	FT1355-T-33
30 X 2.5	FT1455-NT-30x4.0	FT1355-H-36	FT1355-A-33	FT1355-T-30
30 X 3	FT1455-NT-30x4.0	FT1355-H-36	FT1355-A-33	FT1355-T-30
30 X 4	FT1455-NT-30x4.0	FT1355-H-36	FT1355-A-33	FT1355-T-30
35 X 2	FT1455-NT-35x3.0	FT1355-H-45	FT1355-A-40	FT1355-T-40
35 X 3	FT1455-NT-35x3.0	FT1355-H-40	FT1355-A-36	FT1355-T-36
35 X 4	FT1455-N-H25	FT1355-H-40	FT1355-A-36	FT1355-T-33
35 X 5	FT1455-N-H25	FT1355-H-36	FT1355-A-33	FT1355-T-30
38 X 2.5	FT1455-NT-38x5.0	FT1355-H-50	FT1355-A-45	FT1355-T-40
38 X 3	FT1455-NT-38x5.0	FT1355-H-50	FT1355-A-45	FT1355-T-40
38 X 4	FT1455-NT-38x5.0	FT1355-H-45	FT1355-A-40	FT1355-T-40
38 X 5	FT1455-NT-38x5.0	FT1355-H-40	FT1355-A-36	FT1355-T-36
42 X 2	FT1455-NT-42x3.0	FT1355-H-55	FT1355-A-50	FT1355-T-50
42 X 3	FT1455-NT-42x3.0	FT1355-H-50	FT1355-A-50	FT1355-T-45
50 X 3	FT1455-NT-50x5.0	FT1355-H-60	FT1355-A-55	FT1355-T-55
50 X 5	FT1455-NT-50x5.0	FT1355-H-55	FT1355-A-55	FT1355-T-50
50 X 6	FT1455-NT-50x5.0	FT1355-H-55	FT1355-A-50	FT1355-T-50

Contamination control

## FT1355 series

### Cleaning projectiles for hose, tube and pipe assemblies

FT1355 cleaning projectiles work by being compressed against the internal surface of the hose, tube or pipe. Cleaning projectile selection should favor a diameter 20% to 30% larger than the internal diameter of the hose, tube or pipe being cleaned.

Projectiles are available in 3 variations as outlined below, and are manufactured from virgin materials with a specific cell structure and density to match the application's needs. Appropriate selection of the cleaning projectile based on the type of application ensures effective cleaning.



## FT1355-H-XX

### Hose cleaning projectiles for hose assemblies

- Universal cleaning projectile for use with hose, tube and pipe assemblies
- Removes fine particles of loose contaminants after cutting operations
- Can also be used for product purging prior to assembly

#### FT1355-H-XX cleaning projectiles for hose assemblies

Part #	Description
FT1355-H-05	Hose cleaning projectile (5mm)
FT1355-H-06	Hose cleaning projectile (6mm)
FT1355-H-07	Hose cleaning projectile (7mm)
FT1355-H-08	Hose cleaning projectile (8mm)
FT1355-H-10	Hose cleaning projectile (10mm)
FT1355-H-12	Hose cleaning projectile (12mm)
FT1355-H-14	Hose cleaning projectile (14mm)
FT1355-H-16	Hose cleaning projectile (16mm)
FT1355-H-18	Hose cleaning projectile (18mm)
FT1355-H-20	Hose cleaning projectile (20mm)
FT1355-H-22	Hose cleaning projectile (22mm)
FT1355-H-24	Hose cleaning projectile (24mm)
FT1355-H-26	Hose cleaning projectile (26mm)
FT1355-H-28	Hose cleaning projectile (28mm)
FT1355-H-30	Hose cleaning projectile (30mm)
FT1355-H-33	Hose cleaning projectile (33mm)
FT1355-H-36	Hose cleaning projectile (36mm)
FT1355-H-40	Hose cleaning projectile (40mm)
FT1355-H-45	Hose cleaning projectile (45mm)
FT1355-H-50	Hose cleaning projectile (50mm)
FT1355-H-55	Hose cleaning projectile (55mm)
FT1355-H-60	Hose cleaning projectile (60mm)
FT1355-H-65	Hose cleaning projectile (65mm)
FT1355-H-70	Hose cleaning projectile (70mm)
FT1355-H-75	Hose cleaning projectile (75mm)
FT1355-H-80	Hose cleaning projectile (80mm)
FT1355-H-85	Hose cleaning projectile (85mm)
FT1355-H-90	Hose cleaning projectile (90mm)
FT1355-H-95	Hose cleaning projectile (95mm)
FT1355-H-100	Hose cleaning projectile (100mm)

## FT1355 series

### Cleaning projectiles for tube and pipe assemblies



### FT1355-A-XX

#### Abrasive cleaning projectiles for tube and pipe assemblies

- For use with tubes or pipe assemblies
- Removes mild to medium amounts of contaminants including surface rust and scale build-up
- Can be used multiple times

#### FT1355-A-XX abrasive cleaning projectiles for tube and pipe assemblies

Part #	Description
FT1355-A-06	Abrasive cleaning projectile (6mm)
FT1355-A-07	Abrasive cleaning projectile (7mm)
FT1355-A-10	Abrasive cleaning projectile (10mm)
FT1355-A-12	Abrasive cleaning projectile (12mm)
FT1355-A-14	Abrasive cleaning projectile (14mm)
FT1355-A-16	Abrasive cleaning projectile (16mm)
FT1355-A-18	Abrasive cleaning projectile (18mm)
FT1355-A-20	Abrasive cleaning projectile (20mm)
FT1355-A-22	Abrasive cleaning projectile (22mm)
FT1355-A-24	Abrasive cleaning projectile (24mm)
FT1355-A-26	Abrasive cleaning projectile (26mm)
FT1355-A-28	Abrasive cleaning projectile (28mm)
FT1355-A-30	Abrasive cleaning projectile (30mm)
FT1355-A-33	Abrasive cleaning projectile (33mm)
FT1355-A-36	Abrasive cleaning projectile (36mm)
FT1355-A-40	Abrasive cleaning projectile (40mm)
FT1355-A-45	Abrasive cleaning projectile (45mm)
FT1355-A-50	Abrasive cleaning projectile (50mm)
FT1355-A-55	Abrasive cleaning projectile (55mm)
FT1355-A-60	Abrasive cleaning projectile (60mm)



### FT1355-T-XX

#### Tube cleaning projectiles for tube and pipe assemblies

- Cleaning projectiles for use with tube and pipe assemblies
- Removes mild to medium amounts of contaminants including surface rust and scale build-up
- Removes mandrel lubricants, grease and other oils typically used in bending processes
- Strongly recommended for cleaning stainless steel tubes

#### FT1355-T-XX tube cleaning projectiles for tube assemblies

Part #	Description
FT1355-T-06	Tube cleaning projectile (6mm)
FT1355-T-07	Tube cleaning projectile (7mm)
FT1355-T-10	Tube cleaning projectile (10mm)
FT1355-T-12	Tube cleaning projectile (12mm)
FT1355-T-14	Tube cleaning projectile (14mm)
FT1355-T-16	Tube cleaning projectile (16mm)
FT1355-T-18	Tube cleaning projectile (18mm)
FT1355-T-20	Tube cleaning projectile (20mm)
FT1355-T-22	Tube cleaning projectile (22mm)
FT1355-T-24	Tube cleaning projectile (24mm)
FT1355-T-26	Tube cleaning projectile (26mm)
FT1355-T-28	Tube cleaning projectile (28mm)
FT1355-T-30	Tube cleaning projectile (30mm)
FT1355-T-33	Tube cleaning projectile (33mm)
FT1355-T-36	Tube cleaning projectile (36mm)
FT1355-T-40	Tube cleaning projectile (40mm)
FT1355-T-45	Tube cleaning projectile (45mm)
FT1355-T-50	Tube cleaning projectile (50mm)
FT1355-T-55	Tube cleaning projectile (55mm)
FT1355-T-60	Tube cleaning projectile (60mm)

Contamination control

## FT1355 series

### Cleaning projectile selection ordering guidelines

Order quantity is one bag  
(ex.. A 1 piece order will be for the full bag quantity noted below)

FT1355 projectile ordering guide

Danfoss projectile part #	Description	Qty / bag
FT1355-A-06	ABRASIVE (06mm) (Pkg 100)	100
FT1355-A-07	ABRASIVE (07mm) (Pkg 100)	100
FT1355-A-10	ABRASIVE (10mm) (Pkg 100)	100
FT1355-A-12	ABRASIVE (12mm) (Pkg 100)	100
FT1355-A-14	ABRASIVE (14mm) (Pkg 100)	100
FT1355-A-16	ABRASIVE (16mm) (Pkg 100)	100
FT1355-A-18	ABRASIVE (18mm) (Pkg 100)	100
FT1355-A-20	ABRASIVE (20mm) (Pkg 50)	50
FT1355-A-22	ABRASIVE (22mm) (Pkg 50)	50
FT1355-A-24	ABRASIVE (24mm) (Pkg 50)	50
FT1355-A-26	ABRASIVE (26mm) (Pkg 50)	50
FT1355-A-28	ABRASIVE (28mm) (Pkg 40)	40
FT1355-A-30	ABRASIVE (30mm) (Pkg 40)	40
FT1355-A-33	ABRASIVE (33mm) (Pkg 40)	40
FT1355-A-36	ABRASIVE (36mm) (Pkg 30)	30
FT1355-A-40	ABRASIVE (40mm) (Pkg 30)	30
FT1355-A-45	ABRASIVE (45mm) (Pkg 20)	20
FT1355-A-50	ABRASIVE (50mm) (Pkg 20)	20
FT1355-A-55	ABRASIVE (55mm) (Pkg 15)	15
FT1355-A-60	ABRASIVE (60mm) (Pkg 15)	15
FT1355-H-05	Low density hose projectile (5mm)	100
FT1355-H-06	Low density hose projectile (6mm)	100
FT1355-H-07	Low density hose projectile (7mm)	100
FT1355-H-08	Low density hose projectile (8mm)	100
FT1355-H-10	Low density hose projectile (10mm)	100
FT1355-H-12	Low density hose projectile (12mm)	100
FT1355-H-14	Low density hose projectile (14mm)	100
FT1355-H-16	Low density hose projectile (16mm)	100
FT1355-H-18	Low density hose projectile (18mm)	100
FT1355-H-20	Low density hose projectile (20mm)	50
FT1355-H-22	Low density hose projectile (22mm)	50
FT1355-H-24	Low density hose projectile (24mm)	50
FT1355-H-26	Low density hose projectile (26mm)	50
FT1355-H-28	Low density hose projectile (28mm)	40
FT1355-H-30	Low density hose projectile (30mm)	40

FT1355 projectile ordering guide

Danfoss projectile part #	Description	Qty / bag
FT1355-H-33	Low density hose projectile (33mm)	40
FT1355-H-36	Low density hose projectile (36mm)	30
FT1355-H-40	Low density hose projectile (40mm)	30
FT1355-H-45	Low density hose projectile (45mm)	20
FT1355-H-50	Low density hose projectile (50mm)	20
FT1355-H-55	Low density hose projectile (55mm)	15
FT1355-H-60	Low density hose projectile (55mm)	15
FT1355-H-65	Low density hose projectile (60mm)	10
FT1355-H-70	Low density hose projectile (65mm)	10
FT1355-H-75	Low density hose projectile (70mm)	10
FT1355-H-80	Low density hose projectile (80mm)	10
FT1355-H-85	Low density hose projectile (85mm)	10
FT1355-H-90	Low density hose projectile (90mm)	10
FT1355-H-95	Low density hose projectile (95mm)	10
FT1355-H-100	Low density hose projectile (100mm)	10
FT1355-T-06	Tube projectile (06mm)	100
FT1355-T-07	Tube projectile (07mm)	100
FT1355-T-10	Tube projectile (10mm)	100
FT1355-T-12	Tube projectile (12mm)	100
FT1355-T-14	Tube projectile (14mm)	100
FT1355-T-16	Tube projectile (16mm)	100
FT1355-T-18	Tube projectile (18mm)	100
FT1355-T-20	Tube projectile (20mm)	50
FT1355-T-22	Tube projectile (22mm)	50
FT1355-T-24	Tube projectile (24mm)	50
FT1355-T-26	Tube projectile (26mm)	50
FT1355-T-28	Tube projectile (28mm)	40
FT1355-T-30	Tube projectile (30mm)	40
FT1355-T-33	Tube projectile (33mm)	40
FT1355-T-36	Tube projectile (36mm)	30
FT1355-T-40	Tube projectile (40mm)	30
FT1355-T-45	Tube projectile (45mm)	20
FT1355-T-50	Tube projectile (50mm)	20
FT1355-T-55	Tube projectile (55mm)	15
FT1355-T-60	Tube projectile (60mm)	15

## FT1355 series

### Cleaning projectile selection ordering guidelines

Order quantity is one bag  
(ex. A 1 piece order will be for the full bag quantity noted below)

FT1355 cleaning projectile ordering		
FT1355 foam projectile part #'s for FT1455 projectile launchers	Order quantity is one bag (ex. A 1 piece order will be for the full bag quantity noted below)	Inner Diameter (ID) in inches of cut hose, and Hose assembly Dash size
<b>FT1355-H-06</b>	100	3/16" (-03)
<b>FT1355-H-10 (or)</b>	100	1/4" (-04)
<b>FT1355-H-12*</b>	100	
<b>FT1355-H-12 (or)</b>	100	5/16" (-05)
<b>FT1355-H-14*</b>	100	
<b>FT1355-H-14 (or)</b>	100	3/8" (-06)
<b>FT1355-H-16*</b>	100	
<b>FT1355-H-18 (or)</b>	100	1/2" (-08)
<b>FT1355-H-20*</b>	50	
<b>FT1355-H-22</b>	50	5/8" (-10)
<b>FT1355-H-26</b>	50	3/4" (-12)

FT1355 cleaning projectile ordering		
FT1355 foam projectile part #'s for FT1455 projectile launchers	Order quantity is one bag (ex. A 1 piece order will be for the full bag quantity noted below)	Inner Diameter (ID) in inches of cut hose, and Hose assembly Dash size
<b>FT1355-H-33 (or)</b>	40	1" (-16)
<b>FT1355-H-36*</b>	30	
<b>FT1355-H-40</b>	30	1-1/4" (-20)
<b>FT1355-H-45*</b>	20	
<b>FT1355-H-50 (or)</b>	20	1-1/2" (-24)
<b>FT1355-H-55*</b>	15	
<b>FT1355-H-60 (or)</b>	15	2" (-32)
<b>FT1355-H-65*</b>	10	
<b>FT1355-H-75</b>	10	2-1/2" (-40)
<b>FT1355-H-85</b>	10	3" (-48)
<b>FT1355-H-100</b>	10	3-1/2" (-64)

**NOTE:** \*Use the larger projectile size for maximum cleaning on hose cut with an abrasive wheel



## FT1555 CapSeal system



The FT1555 CapSeal system is intended to be used in conjunction with the FT1355 and FT1455 series projectile cleaning systems to prevent recontamination of hose, tube, and pipe assemblies. The FT1555 CapSeal system utilizes heat shrink technology to encapsulate the end of a hose or tube assembly with an FT1555 CapSeal capsule.

- Provides industry leading ISO cleanliness levels
- Robust construction for use in heavy duty applications
- Available in hand-held and bench-mount configurations
- Ideal for portable small volume applications, and large volume production applications
- Optimum CapSeal capsule design to meet a broad variety of applications
- Minimal setup
- Capability: 3/8" (10mm) to 3" (78mm OD) hose and fitting ends
- Available in kits or individual replacement hardware components
- Kits available with and without Capseal capsule

Capsule shrink time for CapSeal Systems at multiple intervals

Machine warm-up time from cold start (minutes)	1	2	3	4	5	6	7	8	9	10
Machine	Seal time (seconds)									
<b>FT1555-BM230</b> 	3.5	2.5	2	1.5	1.25	1	1	0.75	0.75	0.75
<b>FT1555-BM120</b> 	17	10	4.5	3.25	2.5	2.25	2	1.75	1.5	1.5
<b>FT1555-HH</b> 	10	12	6	4	3	3	2.5	2	1.75	1.75

## FT1555 CapSeal system

### Hardware



### FT1555-HH

#### Hand held electric heat gun

- Variable temperature electronic heat gun with electronic thermocouple control.
- Duratherm heating element ensure long life and even heat temperature range of 120°F (49°C) to 1100°F (593°C) and a built-in cool down switch.
- Capable of sealing multiple hoses simultaneously.
- Operates on 120V AC power, draws 1500 watts, and can produce 17.6CFM.
- Cool down switch renders gun immediately cool-to-the-touch.

### FT1555-BM120

#### 120v Ak hand held heat gun with air knife



- A cradle holds and locks the 120V heat gun into place for bench top shrinking of capsules.
- The heat gun can be easily removed from the cradle for remote capsule shrinking.
- Magnetic puck holds the capsule onto the fitting for a perfect seal during the shrinking process.
- Magnetic puck pulls the swivel nut forward on 90° and 45° fittings for easy insertion into the air knife for capsule shrinking.
- Air knife has heat guard and large 110mm center opening that can be accessed from either side.
- Can seal single or multiple hose or tube assemblies.
- CapSeal capsules will seal hose or tube fitting from 3/8" OD (10mm) through 3" OD (78mm).



### FT1555-BM230

#### CapSeal system with air knife

- Enables sealing of single or multiple hose or tube assemblies at one time.
- Magnetic puck holds capsule onto carbon steel fitting for a perfect seal during sealing process.
- Magnetic puck holds the nut forward on 90° and 45° fittings for easy insertion into the air knife.
- Air knife has heat guard and large 110mm center opening accessible from either side.
- Capsules fit and seal hose and tube fittings from 3/8" OD (10mm) through 3" OD (78mm).
- 230v single-phase AC power at 50/60Hz draws < 5 amps.
- ON/OFF rocker switch illuminates green when "on."
- Built in external air filter minimizes heat gun clogging and maintenance, increasing heat gun longevity.
- Heat side of machine is fully insulated.
- Dedicated air filter prevents airborne contamination during sealing.
- Please note that a L6-15 NEMA twist loc receptacle (not supplied) is required for operation.
- Durable, long-lasting brushless motor for high-volume production environments.

Contamination control

# FT1555 CapSeal system

Kits



## FT1555-HH-K1

**Hand held electric heat gun basic kit**

- Typical applications – Hose shops and mobile hose fabricators
- Capsules fit and seal hose and tube fittings from 3/8" OD (10mm) through 3" OD (78mm)
- FT1555-HH heat gun and air knife with 1 1/2" connection
- FT1555-SMP small magnetic puck
- FT1555-LMP large magnetic puck



## FT1555-HH-K2

**Hand held electric heat gun starter kit**

- Typical applications – Hose shops and mobile hose fabricators
- Capsules fit and seal hose and tube fittings from .55" OD (14mm) through 1.73" OD (44mm)
- FT1555-1824UP CapSeal Capsules 18mm x 24mm (ID x LENGTH)
- FT1555-2030UP CapSeal Capsules 20mm x 30mm (ID x LENGTH)
- FT1555-2540UP CapSeal Capsules 25mm x 40mm (ID x LENGTH)
- FT1555-2840UP CapSeal Capsules 28mm x 40mm (ID x LENGTH)
- FT1555-3140UP CapSeal Capsules 31mm x 40mm (ID x LENGTH)
- FT1555-3440UP CapSeal Capsules 34mm x 40mm (ID x LENGTH)
- FT1555-3840UP CapSeal Capsules 38mm x 40mm (ID x LENGTH)
- FT1555-4650UP CapSeal Capsules 46mm x 50mm (ID x LENGTH)



## FT1555-HH-K3

**Hand held electric heat gun premium starter kit**

- Typical applications – Hose shops and mobile hose fabricators
- Capsules fit and seal hose and tube fittings from .55" OD (14mm) through 3.07" OD (78mm)
- FT1555-1824UP CapSeal Capsules 18mm x 24mm (ID x LENGTH)
- FT1555-2030UP CapSeal Capsules 20mm x 30mm (ID x LENGTH)
- FT1555-2540UP CapSeal Capsules 25mm x 40mm (ID x LENGTH)
- FT1555-2840UP CapSeal Capsules 28mm x 40mm (ID x LENGTH)
- FT1555-3140UP CapSeal Capsules 31mm x 40mm (ID x LENGTH)
- FT1555-3440UP CapSeal Capsules 34mm x 40mm (ID x LENGTH)
- FT1555-3840UP CapSeal Capsules 38mm x 40mm (ID x LENGTH)
- FT1555-4650UP CapSeal Capsules 46mm x 50mm (ID x LENGTH)
- FT1555-5260UP CapSeal Capsules 52mm x 60mm (ID x LENGTH)
- FT1555-5860UP CapSeal Capsules 58mm x 60mm (ID x LENGTH)
- FT1555-6760UP CapSeal Capsules 67mm x 60mm (ID x LENGTH)
- FT1555-8060UP CapSeal Capsules 80mm x 60mm (ID x LENGTH)



## FT1555 CapSeal system

### Capsules

FT1555 CapSeal capsules eliminate contamination by forming a clean and secure seal around hose and tube ends. FT1555 CapSeal system eliminates the need to stock multiple plastic threaded caps with just 19 CapSeal capsule sizes to meet all type of hose and tube end configurations.

Additionally, the quick and easy pull-off tab on each capsule eliminates the need for additional tools that could further contaminate the assemblies.

FT1555 CapSeal capsules are available in 19 sizes of varying diameter and length to match needs of all assemblies, and are available in both unit packaged and bulk packaged packaging.

Unit packaged CapSeal packages		Bulk packaged CapSeal packages	CapSeal capsule size	Hex sizes covered		Fitting		
CapSeal part #		CapSeal part #	Packaged quantity	(mm, ID X length)	(mm)	(Inches)	Straight	Elbow*
FT1555-1424UP	960	FT1555-1424BP	12,320	14x24	10mm to 13mm	.39" to .51"	x	X
FT1555-1624UP	840	FT1555-1624BP	9,000	16x24	12mm to 15mm	.47" to .59"	X	x
FT1555-1824UP	840	FT1555-1824BP	7,360	18x24	14mm to 17mm	.55" to .67"	X	x
FT1555-2023UP	810	FT1555-2023BP	23,400	20 X 23	12mm to 18mm	0.47" to 0.71"		X
FT1555-2030UP	810	FT1555-2030BP	23,400	20 X 30	12mm to 18mm	0.47" to 0.71"	X	
FT1555-2224UP	810	FT1555-2224BP	22,500	22 X 24	16mm to 21mm	0.63" to 0.63"		X
FT1555-2527UP	800	FT1555-2527BP	17,600	25 X 27	18mm to 23mm	0.71 to 0.91"		X
FT1555-2540UP	800	FT1555-2540BP	17,600	25 X 40	18mm to 23mm	0.71" to 0.91"	X	
FT1555-2840UP	720	FT1555-2840BP	15,200	28 X 40	22mm to 26mm	0.87" to 1.02"	X	
FT1555-3133UP	640	FT1555-3133BP	12,240	31 X 33	24mm to 29mm	0.94" to 1.14"		X
FT1555-3140UP	640	FT1555-3140BP	12,240	31 X 40	24mm to 29mm	0.95" to 1.14"	X	
FT1555-3440UP	640	FT1555-3440BP	10,240	34 X 40	27mm to 32mm	1.07" to 1.26"	X	
FT1555-3840UP	560	FT1555-3840BP	7,800	38 X 40	30mm to 36mm	1.19" to 1.42"	X	X
FT1555-4345UP	480	FT1555-4345BP	6,240	43 X 45	32mm to 41mm	1.26" to 1.61"	X	X
FT1555-4650UP	480	FT1555-4650BP	5,760	46 X 50	34mm to 44mm	1.34" to 1.73"	X	X
FT1555-5260UP	400	FT1555-5260BP	4,400	52 X 60	41mm to 50mm	1.62" to 1.97"	X	X
FT1555-5860UP	400	FT1555-5860BP	3,600	58 X 60	49mm to 56mm	1.93" to 2.20"	X	X
FT1555-6760UP	320	FT1555-6760BP	2,560	67 X 60	55mm to 65mm	2.16" to 2.56"	X	X
FT1555-8060UP	320	FT1555-8060BP	1,736	80 X 60	64mm to 78mm	2.52" to 3.07"	X	X

\* Shorter length CapSeal capsules are recommended for elbow and angled fittings (45° and 90°)

## FT1555 CapSeal system

### Accessories



#### FT1555-HH-AK15

1-1/2" connection

- 110mm air knife to shrink CapSeal capsules
- Accommodates all CapSeal capsules



#### FT1555-HH-AK20

2" connection

- 110mm air knife to shrink CapSeal capsules
- Accommodates all CapSeal capsules



#### Magnetic Puck

FT1555-LMP- Large magnetic puck

FT1555-SMP- Small magnetic puck

Magnetic puck pulls nut forward on hose or tube assemblies to allow proper sealing while being placed in air knife.

## **Weatherhead**

---

Weatherhead by Danfoss

## Danfoss branded cabinets & storage



## Organize your inventory

Danfoss branded stocking cabinets are the ideal way to organize your inventory of Danfoss hose ends, adapters, hoses and assembly tooling.



### C-40X

The sturdy C-40X cabinet contains 40 heavy-duty drawers that can be divided into two, three, or four compartments providing space for a large selection of hose ends and adapters. It has mounting holes for the T-420, ET1187, and ET1000 crimp machines.

46-1/2"H x 40"W;  
26" Deep at base, 18" Deep at top.  
228 lbs.



### C-15X

The rugged C-15X contains 15 extra large drawers that may be divided into two or three sections for those large, difficult to store items.

13 -5/8"H x 30 -1/4"W; 14-3/8" Deep.  
45 lbs.



### C-63X

This stock cabinet containing 63 drawers, which can be divided into two or three sections, is a nice addition to any store front.

25"H x 30 -1/4"W; 9-1/4" Deep.  
61 lbs.



### FC-16X

The FC-16X contains 16 clear poly drawers that can be divided into two or three sections.

11-3/4"H x 16 -1/8"W; 9" Deep.  
13 lbs.



### FH-135X

The sturdy FH-135X cabinet contains 50 heavy-duty drawers that can be divided into one, two, or three compartments allowing ample space for a large selection of hose ends and adapters. It includes mounting holes for the ET1187 and ET1000 crimp machines.

46-1/2"H x 33" W; 14-1/2" Deep.  
115 lbs.



### FH-40X

Provides convenient storage areas for those large size fittings and hose ends. This durable 20 gauge steel cabinet is made to handle abuse

35" wide, 42" high, 12" deep  
200 lbs.

**NOTE: Will not support crimp equipment.**



Danfoss branded cabinets & storage



### C-632X

The C-632X consists of the CB-63X cabinet base, the C-15X cabinet, and two C-63X cabinets. This cabinet is a space saving, efficient addition to the modern store with a lobby type sales area. It requires a minimum amount of space, but does a maximum job merchandising a wide variety of products in 126 clear drawers. An additional 15 large, high impact drawers located in the bottom section provide ample space for large or heavy items.

68-1/2"H x 30" W; 15" Deep.  
Weight: 167 lbs.



### HD-1X

The HD-1X cabinet offers the ideal solution for keeping 50-foot lengths of hose off the floor. Vertical slots in the cabinet keep hoses organized and clean. Consider bolting a C-15X stocking cabinet on top of the HD-1X to keep an inventory of hose ends readily available. Internal dimensions have changed from 7 narrow 4.3" sections to 5 wider 6.14" sections to accommodate larger hose sizes

36"H x 31" W; 24" Deep.  
83 lbs.



### HD-2X

The HD-2X hose display is designed to support the weight of Danfoss bulk reels and boxed product.

22" wide x 30" deep x 57" tall  
54 pounds  
3 Reels or 2 Reels with 4 boxes

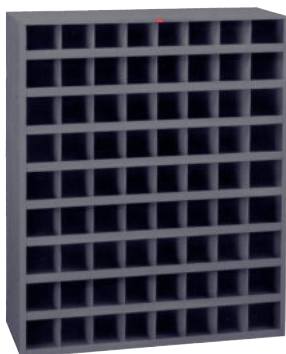

### FH-72X

Large capacity all-welded cabinet provides 72 storage compartments. Fabricated from 20 gauge steel, the FH-72X will provide years of continued service.

35" wide, 42" high, 12" deep  
200 lbs.

**NOTE: Will not support crimp equipment.**



### FT1380DR-12

The lazy susan die cage rack offers easy 360-degree access to 12 of your FT1380 series crimp dies.

18" wide, 10" high, 6" deep  
50 lbs.



### TC-20

The TC-20 cabinet provides easy access to all your tooling needs. This collet cabinet fits Danfoss' core tooling products. Standard holes fit the ET425 series collets. Inserts are provided to fit the ET313 series collets

28-1/2"H x 26-1/2" W; 12-3/4" Deep.  
37.5 lbs.

**Weatherhead**

Replacement drawers/dividers and label sets

## Replacement drawers/dividers

All drawers are clear polypropylene and all dividers are black polypropylene

Replacement drawers/dividers	
Part #	Description
PD-15	Divider for the FH-135X and C-15X
PD-49	Drawer for the C-63X and FC-16X
PD-75SET	Divider for the C-63X and FC-16X (pack of 14)
PD-95	Drawer for the FH-135X
CD-15	Drawer for the C-15X
PD-20	Divider for the C-40X
PD-40	Drawer for the C-40X

## Self adhesive label sets

For C-40X, C-15X, and FH-135X cabinets

Self adhesive label sets	
Label #	Description
FF00000	Blank label sheet (8.5 X 11 blank bin label pages supporting up to 46 labels each)
FF17266	1A series hose ends label set
FF17266-NOBC	1A series hose ends label set (without barcode)
FF90645	Z series hose ends label set
FF90645-NOBC	Z series hose ends label set (without barcode)
FF90646	E-Z Clip label set
FF91420	4S/6S series hose ends label set
FF91420-NOBC	4S/6S series hose ends label set (without barcode)
FF91475	Core positive stop style tooling label set
FF91475-NOBC	Core positive stop style tooling label set (without barcode)
FF91610	4TA series hose ends label set
FF91610-NOBC	4TA series hose ends label set (without barcode)

## Plastic bags



Danfoss heavy duty plastic bags for Danfoss fittings come in sizes 5"x6", 6"x10", and 8"x12". The bags include convenient spaces for labeling.

Self adhesive label sets		
Part #	Description	Qty
5X6 PB	Plastic bag	100
6X10 PB	Plastic bag	100
8X12 PB	Plastic bag	100

Weatherhead by Danfoss

## Safety information



Important Safety Information

**Safety Information**

**Weatherhead by Danfoss Hose and Fitting Assembly Product Warning**

Flexible hose lines offer many advantages over rigid tubing including routing ease, vibration absorption, sound deafening and the ability to accommodate movement of connected components. However, hose lines require caution in use not only to provide long service, but also to guard against potentially dangerous failure.

The user should carefully observe the precautions listed in this catalog, including the recommendations on the selection of hose and fittings on the relevant pages, and the pages on fluid compatibility. In addition, care should be taken not to exceed the minimum bend radius listed for each hose size and type in the hose section. Maximum operating pressure should not exceed pressures listed in the hose data. Instructions for assembling fittings to different hose should be followed carefully to ensure the performance of the completed assembly.

**WARNING** 

Danfoss fitting tolerances are engineered to match Danfoss' Weatherhead hose tolerances. The use of Danfoss fittings on hose supplied by other manufacturers and/or the use of Danfoss' Weatherhead hose with fittings supplied by other manufactures may result in the production of unreliable and unsafe hose assemblies and is neither recommended nor authorized by Danfoss or any of its affiliates or subsidiaries.

**WARNING** 

Application considerations must be observed in selecting appropriate components for the application of these products contained herein. The failure to follow the recommendations set forth in this catalog may result in an unstable application which may result in serious personal injury or property damage.

DANFOSS OR ANY OF ITS AFFILIATES OR SUBSIDIARIES SHALL NOT BE SUBJECT TO AND DISCLAIMS ANY OBLIGATIONS OR LIABILITIES (INCLUDING BUT NOT LIMITED TO ALL CONSEQUENTIAL, INCIDENTAL AND CONTINGENT DAMAGES) ARISING FROM TORT CLAIMS (INCLUDING WITHOUT LIMITATION NEGLIGENCE AND STRICT LIABILITY) OR OTHER THEORIES OF LAW WITH RESPECT TO ANY HOSE ASSEMBLIES NOT PRODUCED FROM GENUINE WEATHERHEAD HOSE FITTINGS, HOSE AND WEATHERHEAD APPROVED EQUIPMENT, AND IN CONFORMANCE WITH DANFOSS' WEATHERHEAD PROCESS AND PRODUCT INSTRUCTIONS FOR EACH SPECIFIC HOSE ASSEMBLY.

Failure to follow these processes and product instructions and limitations could lead to premature hose assembly failures resulting in property damage, serious injury or death.

If the user follows the recommendations on hose line routing and installation as provided herein, improved safety and longer service life of any hose installation will result.

Proper installation of the hose is essential to the proper operation and safe use of the hose and related equipment. Improper installation of the hose can result in serious injury or property damage caused by spraying fluids or flying projectiles. In order to avoid serious bodily injury or property damage resulting from improper installation of the hose, you should carefully review the information in this catalog regarding hose installation.

Some of the factors you must consider in installing the hose properly are:

- Changes in length
- Proper bend radius
- Protection from high temperature sources
- Elbows and adapters to relieve strain
- Rubbing or abrasion
- Twisting
- Improper hose movement

These factors and the other information in this catalog regarding hose installation should be considered by you before installing the hose. If you have any questions regarding proper hose installation, please contact Danfoss Technical Support at 1-888-258-0222.

Proper maintenance of the hose is essential to the safe use of the hose and related equipment. Hose should be stored in a dry place. Hose should also be visually inspected. Any hose that has a cut or gouge in the cover that exposes the reinforcement should be retired from service. Hoses should also be inspected for kinking or broken reinforcement. If the outside diameter of the hose is reduced by 20% at the spot where it is bent then the hose should be retired from service. Inadequate attention to maintenance of the hose can result in hose leakage, bursting, or other failure which can cause serious bodily injury or property damage from spraying fluids, flying projectiles, or other substances.



## Selection, installation and maintenance of hose and assemblies

The following recommendations on selection, installation and maintenance of hose assemblies were established in SAE J1273. Please read these general instructions carefully. More detailed information on many of these subjects is covered in this catalog.

Hose (also includes hose assemblies) has a finite life and there are a number of factors which will reduce its life. This recommended practice is intended as a guide to assist system designers and/or users in the selection, installation, and maintenance of hose.

The designers and users must make a systematic review of each application and then select, install, and maintain the hose to fulfill the requirements of the application. The following are general guidelines and are not necessarily a complete list.

### WARNING

Improper selection, installation, or maintenance may result in premature failures, bodily injury, or property damage.

### 2.1 Applicable documents

The following publications form a part of this specification to the extent specified herein. The latest issue of SAE publications shall apply.

#### 2.1.1 SAE publications

Available from SAE,  
400 Commonwealth Drive, Warrendale, PA  
15096-0001.  
J516—Hydraulic hose fittings  
J517—Hydraulic hose

The following is a list of factors which must be considered before final hose selection can be made.

### 3.1 Pressure

After determining the system pressure, hose selection must be made so that the recommended maximum operating pressure is equal to or greater than the system pressure. Surge pressures higher than the maximum operating pressure will shorten hose life and must be taken into account by the hydraulic designer.

### 3.2 Suction

Hoses used for suction applications must be selected to insure the hose will withstand the negative pressure of the system.

### 3.3 Temperature

Care must be taken to insure that fluid and ambient temperatures, both static and transient, do not exceed the limitations of the hose. Special care must be taken when routing near hot manifolds.

### 3.4 Fluid compatibility

Hose selection must assure compatibility of the hose tube, cover and fittings with the fluid used. Additional caution must be observed in hose selection for gaseous applications.

### 3.5 Size

Transmission of power by means of pressurized fluid varies with pressure and rate of flow. The size of the components must be adequate to keep pressure losses to a minimum and avoid damage to the hose due to heat generation or excessive turbulence.

### 3.6 Routing

Attention must be given to optimum routing to minimize inherent problems.

### 3.7 Environment

Care must be taken to insure that the hose and fittings are either compatible with or protected from the environment to which they are exposed. Environmental conditions such as ultraviolet light, ozone, salt water, chemicals, and air pollutants can cause degradation and premature failure and, therefore, must be considered.

### 3.8 Mechanical loads

External forces can significantly reduce hose life. Mechanical loads which must be considered include excessive flexing, twist, kinking, tensile or side loads, bend radius, and vibration. Use of swivel-type fittings or adapters may be required to insure no twist is put into the hose. Unusual applications may require special testing prior to hose selection.

### 3.9 Abrasion

While hose is designed with a reasonable level of abrasion resistance, care must be taken to protect the hose from excessive abrasion which can result in erosion, snagging and cutting of the hose cover. Exposure of the reinforcement will significantly accelerate hose failure.

### 3.10 Proper end fitting

Care must be taken to insure proper compatibility exists between the hose and coupling selected based on the manufacturer's recommendations substantiated by testing to industry standards such as SAE J517. End fitting components from one manufacturer are usually not compatible with end fitting components supplied by another manufacturer (i.e., using a hose fitting nipple from one manufacturer with a hose socket from another manufacturer). It is the responsibility of the fabricator to consult the manufacturer's written instructions or the manufacturer directly for proper end fitting componentry.

### 3.11 Length

When establishing proper hose length, motion absorption, hose length changes due to pressure, as well as hose and machine tolerances must be considered.

### 3.12 Specifications and standards

When selecting hose, government, industry and manufacturers' specifications and recommendations must be reviewed as applicable.

### 3.13 Hose cleanliness

Hose components vary in cleanliness levels. Care must be taken to insure that the assemblies selected have an adequate level of cleanliness for the application.

### 3.14 Electrical conductivity

Certain applications require that hose be nonconductive to prevent electrical current flow. Other applications require the hose to be sufficiently conductive to drain off static electricity. Hose and fittings must be chosen with these needs in mind.

After selection of proper hose, the following factors must be considered by the installer.

### 4.1 Pre-installation inspection

Prior to installation, a careful examination of the hose must be performed. All components must be checked for correct style, size and length. In addition, the hose must be examined for cleanliness, I.D. obstructions, blisters, loose cover, or any other visible defects.

General hose selection information

## Selection, installation and maintenance of hose and assemblies

The following recommendations on selection, installation and maintenance of hose assemblies were established in SAE J1273. Please read these general instructions carefully. More detailed information on many of these subjects is covered in this catalog.

### 4.2 Follow manufacturers' assembly instructions

Hose assemblies may be fabricated by the manufacturer, an agent for or customer of the manufacturer, or by the user. Fabrication of permanently attached fittings to hydraulic hose requires specialized assembly equipment. Field attachable fittings (screw style and segment clamp style) can usually be assembled without specialized equipment although many manufacturers provide equipment to assist in the operation.

SAE J517 hose from one manufacturer is usually not compatible with SAE J516 fittings supplied by another manufacturer. It is the responsibility of the fabricator to consult the manufacturer's written assembly instructions or the manufacturer's directly before intermixing hose and fittings from two manufacturers. Similarly, assembly equipment from one manufacturer is usually not interchangeable with that of another manufacturer. It is the responsibility of the fabricator to consult the manufacturer's written instructions or the manufacturer directly for proper assembly equipment. Always follow the manufacturer's instructions for proper preparation and fabrication of hose assemblies.

### 4.3 Minimum bend radius

Installation at less than minimum bend radius may significantly reduce hose life. Particular attention must be given to preclude sharp bending at the hose/fitting juncture.

### 4.4 Twist angle and orientation

Hose installations must be such that relative motion of machine components produces bending of the hose rather than twisting.

### 4.5 Securement

In many applications, it may be necessary to restrain, protect, or guide the hose to protect it from damage by unnecessary flexing, pressure surges, and contact with other mechanical components. Care must be taken to insure such restraints do not introduce additional stress or wear points.

### 4.6 Proper connection of ports

Proper physical installation of the hose requires a correctly installed port connection while insuring that no twist or torque is put into the hose.

### 4.7 Avoid external damage

Proper installation is not complete without insuring that tensile loads, side loads, kinking, flattening, potential abrasion, thread damage, or damage to sealing surfaces are corrected or eliminated.

### 4.8 System check out

After completing the installation, all air entrapment must be eliminated and the system pressurized to the maximum system pressure and checked for proper function and freedom from leaks.

**NOTE:** Avoid potential hazardous areas while testing.

Even with proper selection and installation, hose life may be significantly reduced without a continuing maintenance program. Frequency should be determined by the severity of the application and risk potential. A maintenance program should include the following as a minimum.

### 5.1 Hose storage

Hose products in storage can be affected adversely by temperature, humidity, ozone, sunlight, oils, solvents, corrosive liquids and fumes, insects, rodents and radioactive materials. Storage areas should be relatively cool and dark and free of dust, dirt, dampness and mildew.

### 5.2 Visual inspection

Any of the following conditions requires replacement of the hose: Leaks at fitting or in hose (leaking fluid is a fire hazard). Damaged, cut, or abraded cover (any reinforcement exposed) Kinked, crushed, flattened, or twisted hose Hard, stiff, heat cracked or charred hose Blistered, soft, degraded, or loose cover Cracked, damaged, or badly corroded fittings Fitting slippage on hose

### 5.3 Visual inspection

The following items must be tightened, repaired, or replaced as required:

Leaking port conditions

Clamps, guards, shields

Remove excessive dirt buildup

System fluid level, fluid type, and any air entrapment

### 5.4 Functional test

Operate the system at maximum operating pressure and check for possible malfunctions and freedom from leaks.

**NOTE:** Avoid potential hazardous areas while testing.

### 5.5 Replacement intervals

Specific replacement intervals must be considered based on previous service life, government or industry recommendations, or when failures could result in unacceptable down time, damage, or injury risk.

## How to order

Accurate processing and prompt delivery of your order depends on easy identification of your requirements. Please order Weatherhead brand parts using correct part numbers as described in this catalog. Inquiries and orders should be directed to your Weatherhead distributor or:

Dash size designates the nominal size in 16th of an inch. This number immediately follows the part number and is separated from it with a dash.

Dimensions given in this catalog for Weatherhead products are approximate and should be used for reference only. Exact dimensional information for a given product is subject to change and varying tolerances; contact Danfoss directly for full current information.

### **WARNING**

#### Hose assemblies

Danfoss manufactures the terminal ends of our hose fittings to the appropriate requirements established by the SAE. Therefore, the performance ratings of these hose fittings meet the SAE requirements. It is possible to order a hose assembly with a fitting terminal end that has a performance rating lower than the hose rating. When ordering hose assemblies, please keep the connecting end performance rating in mind since this may affect overall hose assembly performance. Hose assembly components (hose and fittings) are easily assembled in the field. However, factory assembled reusable and crimped hose assemblies are available. For complete information, contact Danfoss.

# Weatherhead

Hose selection: Flow capacities

## Flow capacities of hose assemblies at suggested flow velocities

The chart below is designed and provided as an aid in the determination of the correct hose size.

At 13 U.S. gallons per minute, what is proper hose size within the suggested velocity range for pressure lines?

Locate 13 U.S. gallons per minute in the left hand column and 10 feet per second in the right hand column (the center of the suggested velocity range for pressure lines). Lay a straightedge across the two points. The inside diameter is shown in the center column nearest the straight edge.

For suction hose, follow the same procedure except use suggested velocity range for pump inlet lines in the right hand column.

$$\text{Area (sq. in.)} = \frac{\text{G.P.M.} \times 0.3208}{\text{Velocity (FT./SEC.)}}$$

\* Suggestions are for oils having a maximum viscosity of 315 S.S.U. at +100°F (+38°C) and operating at temperatures between +65°F and +155°F (+54°C to +69°C). Under certain conditions, velocities in pressure lines can be increased up to 25 feet per second. Contact Danfoss with specific information on your application.

To convert U.S. gallons into Imperial gallons multiply U.S. gallons by 0.83267. Imperial gallons into U.S. gallons multiply Imperial gallons by 1.20095. U.S. gallons to liters multiply by 3.785. Liters to U.S. gallons, multiply by 0.2642.

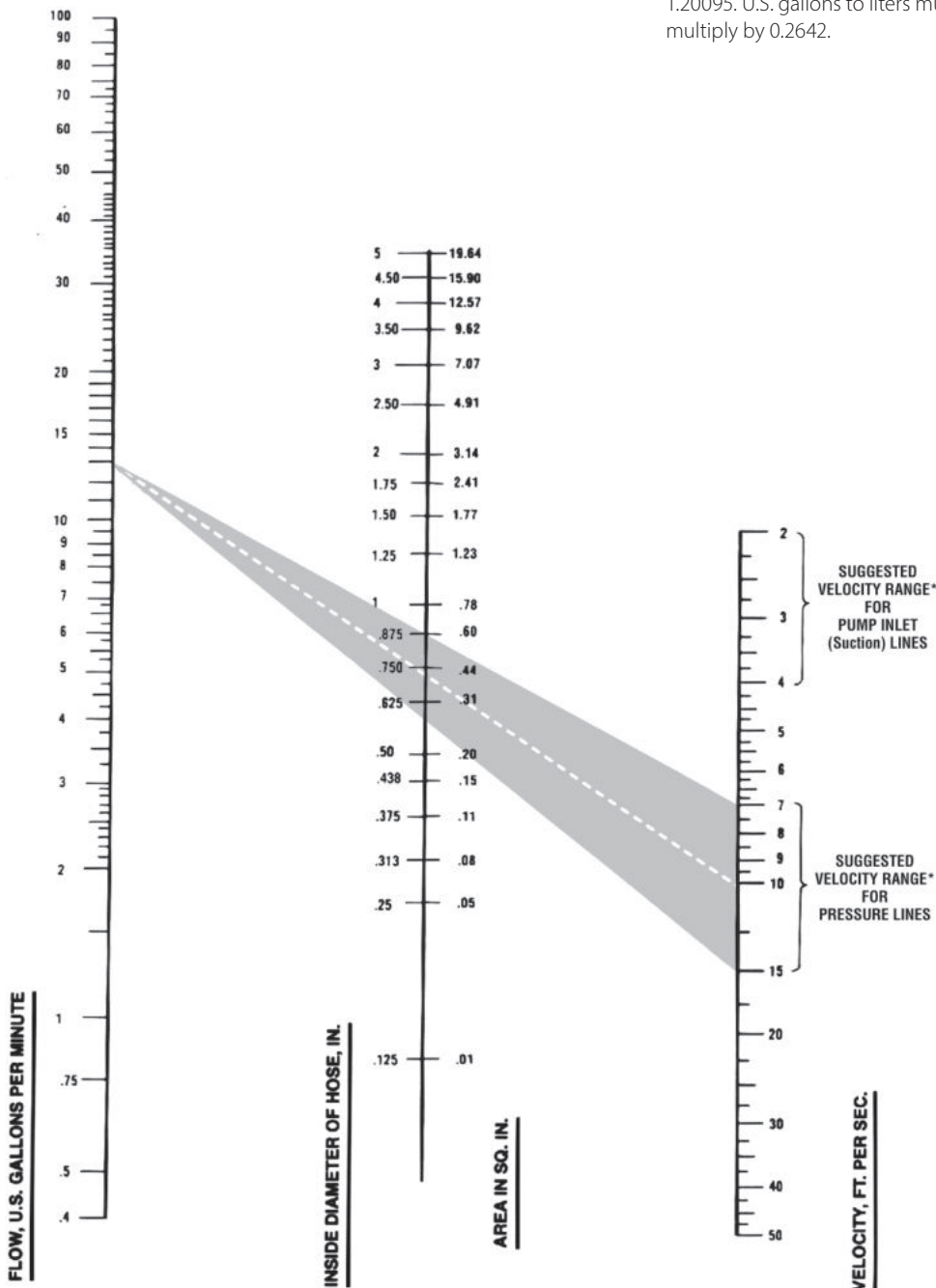

## Flow capacities pressure drop

Pressure drop in psi (pounds per square inch)/ gpm (gallons per minute) for 10 feet of hose (smooth bore) without fittings.

Fluid specification:  
Specific gravity = 0.85;  
Viscosity =  $\nu$  =  
20 centistokes (C.S.),  
(20 C.S. = 97 S.S.U.).

Hose pressure drop																						
Hose dash size	-04		-05		-06		-08		-10		-12		-16		-20		-24		-32		-40	-48
Hose I.D. (inches)	0.19	0.25	0.25	0.31	0.31	0.38	0.41	0.50	0.50	0.63	0.63	0.75	0.88	1.00	1.13	1.25	1.38	1.50	1.81	2.00	2.38	3.00
0.25	10	3.1	3.1	-	-	-	-	-	-	-	-	-	-	-	-	-	-	-	-	-	-	-
0.50	19	6	6	2.7	2.7	-	-	-	-	-	-	-	-	-	-	-	-	-	-	-	-	-
1	40	12	12	5.5	5.5	2.4	-	-	-	-	-	-	-	-	-	-	-	-	-	-	-	-
2	95	24	24	10	10	4.8	3.5	-	-	-	-	-	-	-	-	-	-	-	-	-	-	-
3	185	46	46	17	17	7	5	2.2	2.2	-	-	-	-	-	-	-	-	-	-	-	-	-
4	-	78	78	29	29	12	8	3	3	1.2	1.2	-	-	-	-	-	-	-	-	-	-	-
5	-	120	120	44	44	18	12	4.5	4.5	1.6	1.6	0.72	-	-	-	-	-	-	-	-	-	-
8	-	-	-	95	95	39	26	10	10	3.6	3.6	1.4	0.60	-	-	-	-	-	-	-	-	-
10	-	-	-	-	-	59	40	15	15	5.7	5.7	2	1	0.55	-	-	-	-	-	-	-	-
12	-	-	-	-	-	80	52	20	20	7.2	7.2	2.6	1.5	0.75	0.43	-	-	-	-	-	-	-
15	-	-	-	-	-	-	75	30	30	10	10	4.2	2.2	1.2	0.67	0.38	-	-	-	-	-	-
18	-	-	-	-	-	-	107	40	40	15	15	6.3	3	1.5	0.70	0.55	0.35	-	-	-	-	-
20	-	-	-	-	-	-	-	49	49	19	19	8	3.4	2	1.1	0.65	0.43	0.27	-	-	-	-
25	-	-	-	-	-	-	-	72	72	26	26	11	5.5	3	1.6	1	0.64	0.40	0.17	-	-	-
30	-	-	-	-	-	-	-	-	-	34	34	14	7	3.6	2.2	1.3	0.80	0.52	0.22	0.14	-	-
35	-	-	-	-	-	-	-	-	-	47	47	19	9.5	5	2.8	1.7	1.1	0.70	0.27	0.18	-	-
40	-	-	-	-	-	-	-	-	-	-	-	25	12	6.5	3.4	2.2	1.4	0.90	0.38	0.24	-	-
50	-	-	-	-	-	-	-	-	-	-	-	36	17	9	5.3	3.3	2	1.3	0.54	0.35	0.15	-
60	-	-	-	-	-	-	-	-	-	-	-	50	23	12	7.5	4.4	2.8	1.8	0.75	0.45	0.20	-
70	-	-	-	-	-	-	-	-	-	-	-	-	31	17	9.3	6	3.8	2.4	1	0.65	0.30	-
80	-	-	-	-	-	-	-	-	-	-	-	-	38	21	12	7.1	4.6	3	1.2	0.76	0.34	0.11
90	-	-	-	-	-	-	-	-	-	-	-	-	49	27	15	9	5.9	3.8	1.5	1	0.45	0.13
100	-	-	-	-	-	-	-	-	-	-	-	-	-	33	19	12	7	4.7	1.9	1.3	0.55	0.18
150	-	-	-	-	-	-	-	-	-	-	-	-	-	60	36	22	13	8.5	3.4	2.2	1	0.33
200	-	-	-	-	-	-	-	-	-	-	-	-	-	-	-	36	23	15	6	3.9	1.7	0.55
250	-	-	-	-	-	-	-	-	-	-	-	-	-	-	-	54	33	22	8.5	5.3	2.5	0.75
300	-	-	-	-	-	-	-	-	-	-	-	-	-	-	-	-	45	29	12	7.5	4	1.1
400	-	-	-	-	-	-	-	-	-	-	-	-	-	-	-	-	-	51	21	14	6.5	2.2
500	-	-	-	-	-	-	-	-	-	-	-	-	-	-	-	-	-	-	32	20	10	3
800	-	-	-	-	-	-	-	-	-	-	-	-	-	-	-	-	-	-	-	-	18	5
1000	-	-	-	-	-	-	-	-	-	-	-	-	-	-	-	-	-	-	-	-	-	10

\* Pressure drop values listed are typical of many petroleum based hydraulic oils at approximately +100°F (+38°C). Differences in fluids, fluid temperature and viscosity can increase or decrease actual pressure drop compared to the values listed.

To convert

To convert U.S. gallons into Imperial gallons multiply U.S. gallons by 0.83267. Imperial gallons into U.S. gallons multiply Imperial gallons by 1.20095. U.S. gallons to litres multiply by 3.785. Litres to U.S. gallons, multiply by 0.2642.

# Weatherhead

Hose selection: hose fitting pressure charts

## Thread style pressure performance

Danfoss closely follows industry standards in design and in application recommendations. A key principle within ISO, SAE and other standards bodies is that the **maximum dynamic working pressure of the hose or adapter assembly** is the lesser of the hose and end connector(s) used.

The first table below provides excerpts from standard industry pressure rating charts for connector types as published by SAE (Society of Automotive Engineers).

**Note 1:** The tables below are applicable for low carbon free machining steels typically used in Fluid Power connections. For port type connections, the material and design of the port must be considered and may reduce expected strength.

**Note 2:** For high pressure applications Danfoss recommends the use of more robust connector designs such as Code 62 flange or O-Ring face seal.

**Note 3:** Some Danfoss products have higher pressure ratings. Refer to the product page for specific pressure ratings.

Selected SAE pressure ratings											
Dash size	Inch size	37°	Pipe SAE J476	Male ORB SAE J1926 ORS adapt.	Male ORB SAE J1926 non-ORS adapt.	Adjustable SAE J1926 ORS	Adjustable ORB non-ORS	ORS	Inverted flare	Code 61 Flange	Code 62 Flange
-2	1/8	5000	5000	-	5000	-	5000	-	5000	-	-
-3	3/16	5000	-	9000	5000	6000	5000	-	5000	-	-
-4	1/4	4500	5000	9000	5000	6000	4500	9000	4500	-	-
-5	5/16	4000	-	9000	5000	6000	4500	9000	4000	-	-
-6	3/8	4000	4000	9000	5000	6000	4000	9000	4000	-	-
-8	1/2	4000	3000	9000	4500	6000	4000	9000	4000	5000	6000
-10	5/8	3000	-	9000	3500	6000	3000	6000	3000	-	-
-12	3/4	3000	2500	6000	3500	6000	3000	6000	3000	5000	6000
-14	7/8	2500	-	6000	3000	6000	2500	6000	2500	-	-
-16	1	2500	2000	6000	3000	5000	2500	6000	2500	5000	6000
-20	1 1/4	2000	1150	4000	2500	4000	2000	3600	2000	4000	6000
-24	1 1/2	1500	1000	4000	2500	3000	2000	3600	1500	3000	6000
-32	2	1125	1000	3000	2000	2500	1500	3000	1125	3000	6000

Maximum working pressure (PSI)											
Hose fitting connection	Hose fitting size										
	-04	-05	-06	-08	-10	-12	-16	-20	-24	-32	
Male British Pipe (BSP)	5000	-	4000	4000	3500	4000	3500	2500	2,000	2000	
Female British Pipe (BSP)	5000	-	4000	4000	3500	4000	3500	2500	2,000	2000	
Female Pipe (JIS)	5000	-	5000	5000	-	4000	4000	-	-	-	

Maximum working pressure (PSI)											
Hose fitting Connection	Hose fitting size										
	-06	-08	-10	-12	-15	-18	-22	-28	-35	-42	
DIN light	3625	3625	3625	3625	3625	2325	2325	1450	1450	1450	

## Hose fitting pressure charts

With higher pressures it is critical to know the construction materials and manufacturing method to ensure performance. When all components in a system are Danfoss supplied, for example an Danfoss hose fitting is mated

with an Danfoss adapter or tube fitting, the combination may be used at higher pressures with confidence. These higher ratings are noted in the chart below.

### All Danfoss pressure ratings<sup>1</sup>

Dash Size	Inch Size	37° JIC	Male Pipe	Female Pipe <sup>2</sup>	Male ORB ORS Adapters	Male ORB Non-ORS Adapters	Adjustable ORB ORS Adapters	Adjustable ORB Non-ORS Adapters	ORB	Male Flareless Ermeto	Code 61	Code 62	STC
-2	1/8	-	10000	6000	-	5000	-	5000	-	5000	-	-	-
-3	3/16	-	-	-	9000	5000	6000	5000	-	5000	-	-	-
-4	1/4	7000	9500	5000	9000	5000	6000	4500	9000	4500	-	-	6000
-5	5/16	7000	-	-	9000	5000	6000	4500	-	4000	-	-	-
-6	3/8	5000	8000	4000	9000	5000	6000	4000	9000	4000	-	-	5000
-8	1/2	4000	6000	4000	9000	4500	6000	4000	9000	4000	5000	6000	4250
-10	5/8	3800	-	-	9000	3500	6000	3000	9000	3000	-	-	4000
-12	3/4	5000	5000	3500	6000	3500	6000	3000	6000	3000	5000	6000	4000
-14	7/8	-	-	-	6000	3000	6000	2500	-	2500	-	-	-
-16	1	5000	4000	3000	6000	3000	5000	2500	6000	2500	5000	6000	4000
-20	1 1/4	5000	3000	2000	4000	2500	4000	2000	4500	2000	4000	6000	-
-24	1 1/2	2100	2000	1500	4000	2500	3000	2000	4000	1500	3000	6000	-
-32	2	1750	2000	1500	3000	2000	2500	1500	3000	1125	3000	6000	-

1) These ratings are based on both brazed and one piece construction, one-piece pressures could be increased. Please contact Danfoss in these situations.

2) This rating is for thin walled adapters or fittings, the use of manifolds or oversized female ports would allow full rated male pressures.

Dynamic operating conditions refers to cyclic pressure impulses, usually considered to be from near zero to the highest system pressure. Hydraulic standards typically represent these as square waves and expect a component to handle on the order of 200,000 to well over one million such cycles with a burst: operating safety factor of 4:1. The above charts are created with dynamic applications in mind. Most industrial and mobile hydraulic systems fit the dynamic operating pressure profile, for example hydraulic work circuits on construction equipment or on injection molding equipment.

Static operating conditions typically range from zero to operating pressure, but with far fewer cycles expected for the system life – perhaps 30,000 to 50,000 cycles and sharp pressure spikes are not expected, allowing a burst: operating safety factor of 3:1 or less. For static operating conditions, the Danfoss ratings above can be safely increased by 25-30%. For example, a 3000 psi dynamic rated hose might be used in a 4000 psi static pressure application. Typical examples of static applications are water blast and hydraulic jacking.

The above tables represent performance using common low carbon steel material. Other materials and their characteristics influence these ratings. Medium carbon steels or heat treated materials can support higher working pressures. Conversely non-ferrous materials such as aluminum or brass will have reduced capability – as much as 50%, or less, pressure handling capability. It is important to consider material properties in designing a system to ensure pressure rating compatibility of all materials.

Danfoss' Fluid Conveyance engineering and support teams have many decades of experience in designing, manufacturing and servicing hydraulic and other fluid conveyance systems globally. Danfoss' product line is designed as a comprehensive collection of hose, fittings, connectors, couplings and accessories that allow a system designer to select components to complete a fluid power system or a service technician to replace a component with confidence. The individual product specifications, the above pressure ratings and other technical information are intended as supporting guidelines for system design and service needs and are not to be construed as a guarantee of performance of the system or of individual Danfoss components. Danfoss provides comprehensive technical support so please call with questions about pressure needs not covered by these charts or for specific application support.

Hose selection

**Fluid compatibility**

This chart indicates the suitability of various elastomers and metals for use with fluids to be conveyed. It is intended as a guide only and is not a guarantee. Final selection of the proper hose style, seal, or material of metal components is further dependent on many factors including pressure, fluid and ambient temperature, concentration, duration of exposure, etc.

1. The chart has separate sections for rating elastomers for use as hose inner tubes and as seals. Ratings for a given elastomer may not always be the same in both sections.
2. Both the elastomer and the metal must be considered when determining suitability of a combination for a hose assembly, adapter with o-ring, swivel joint or coupling.
3. Locate the fluid to be conveyed and determine the suitability of the elastomeric and metal components according to the resistance ratings shown for each.
4. Refer to the inner tube materials groupings under "Hose tube identification".
5. Dimensional and operating specifications for each hose can be found on the catalog pages shown with each hose part number.

6. Information on o-rings and seal options for swivel joints and couplings, and how to specify them, are shown in the respective sections of this catalog.
7. For further details on the products shown in this catalog, and their applications, contact:

- = Excellent – Fluid has little or no effect.
- = Good – Fluid has minor to moderate effect.
- = Conditional – Service conditions should be described to Danfoss for determination of suitability for application.
- = Unsatisfactory

The differences between ratings "E" and "G" are relative. Both indicate satisfactory service. Where there is a choice, the materials rated "E" may be expected to give better or longer service than those rated "G".

**NOTE: Special precautions are necessary in gaseous applications due to the potential volume of gaseous fluid in the system. Unless the cover is perforated, hose styles with rubber or thermoplastic covers are not suitable for gases above 250 psi. Hose styles with perforated covers are so noted in their construction descriptions.**

**WARNING**

**Compatibility of hose fittings with conveyed fluid is an essential factor in avoiding chemical reactions that may result in release of fluids or failure of the connection with the potential of causing severe personal injury or property damage.**

**Seal elastomer data**

Seal elastomer		Max. operating temperature range
Buna-N†	none	-40°C to +121°C [-40°F to +250°F]
Neoprene	none	-54°C to +100°C [-65°F to +212°F]
EPR (Ethylene Propylene Rubber)/ EPDM	none	-54°C to +149°C [-65°F to +300°F]
Viton*		-29°C to +204°C [-15°F to +400°F]

†Buna-N temperature range -65°F to +225°F. Also per MIL-R-6855.  
\*Viton is a trademark of The Chemours Company FC, LLC.

1. Nitrile
2. PTFE
3. Synflex thermoplastic elastomer
4. CPE
5. Special application hose (not included in fluid chart)
  - Fuel
  - LPG
  - Railroad air brake
  - Silicone
  - Truck air brake
  - A/C
6. EPDM rubber

The Fluid Compatibility chart is intended for reference use only.

The information in this chart pertains strictly to material compatibility and is not intended to be used as an application guide. For information on specific applications not included in this catalog, please contact Danfoss.

Note 1 - Rubber-covered hose must be perforated to allow gas to escape.

Note 2 - Due to the widely different additives in these fluids, testing should be done on the actual fluid being considered.



This chart is intended for reference use only. The information in this chart pertains strictly to material compatibility and is not intended to be used as an application guide. For information on specific applications not included in this catalog, please contact Danfoss.

\*Viton is a trademark of The Chemours Company FC, LLC.  
 †Hytrell is a registered trademark of E.I. du Pont.  
 ‡Monel is a registered trademark of Special Metals Corporation group of Companies.  
 Note 1 - Rubber-covered hose must be perforated to allow gas to escape.  
 Note 2 - Due to the widely different additives in these fluids, testing should be done on the actual fluid being considered.

Fluid	Hose						Seals						Metal																	
	Nitrile		PTFE		Thermoplastic elastomer		Buna-N		Neoprene		EPR		Viton*		Urethane		Hytrell†		Steel		Brass		Stainless steel		Aluminum		Monel‡			
	1	2	3	4	5	6	1	2	3	4	5	6	1	2	3	4	5	6	1	2	3	4	5	6	1	2	3	4	5	6
Acetic acid, 10%	U	E	C	U	-	G	U	C	C	U	U	G	U	U	G	U	C	G	E	E	E	E	E	E	E	E	E	E		
Acetic acid, glacial	U	E	C	C	-	E	U	U	C	U	U	C	U	U	C	U	U	C	U	U	C	C	C	C	C	C	C	C	C	
Acetone	U	E	G	U	-	E	U	U	G	U	U	G	U	U	G	E	E	E	E	E	E	E	E	E	E	E	E	E	E	
Acetophenone	U	E	-	U	-	E	U	U	E	U	U	-	E	E	E	C	E	E	E	E	E	E	E	E	E	E	E	E	E	
Acetyl acetone	U	E	U	U	-	E	U	U	G	U	U	G	U	U	G	U	C	C	C	C	C	C	C	C	C	C	C	C	C	
Acetyl chloride	U	E	U	U	-	U	U	U	U	E	U	U	C	C	C	U	E	E	E	E	E	E	E	E	E	E	E	E	E	E
Acetylene <sup>1</sup>	G	E	G	G	-	E	U	U	G	E	G	G	E	E	E	E	E	E	E	E	E	E	E	E	E	E	E	E	E	E
Air, hot (up to +160°F) <sup>1</sup>	E	E	E	E	-	E	E	E	E	E	E	E	E	E	E	E	E	E	E	E	E	E	E	E	E	E	E	E	E	E
Air, hot (161°F – 200°F) <sup>1</sup>	C	E	U	E	-	E	G	G	E	E	G	G	E	E	E	E	E	E	E	E	E	E	E	E	E	E	E	E	E	E
Air, hot (201°F – 300°F) <sup>1</sup>	U	E	U	C	-	G	U	U	G	E	U	U	E	E	E	E	E	E	E	E	E	E	E	E	E	E	E	E	E	E
Air wet, below 160°F <sup>1</sup>	E	E	C	E	-	E	E	E	E	E	G	C	U	G	E	E	E	E	E	E	E	E	E	E	E	E	E	E	E	E
Aluminum chloride, 10% aq	E	E	E	E	-	E	E	E	E	E	G	E	U	U	U	U	U	U	U	U	U	U	U	U	U	U	U	U	U	U
Aluminum fluoride, 10% aq	E	E	E	U	-	E	E	E	E	E	G	E	U	U	U	E	C	C	C	C	C	C	C	C	C	C	C	C	C	C
Aluminum nitrate, 10% aq	E	E	E	C	-	E	E	E	E	E	G	E	U	U	C	C	C	C	C	C	C	C	C	C	C	C	C	C	C	C
Aluminum sulfate, 10% aq	E	E	G	E	-	E	E	E	E	E	-	G	U	C	E	C	C	C	C	C	C	C	C	C	C	C	C	C	C	C
Alums, 10% aq	E	E	E	E	-	E	E	E	E	E	E	E	U	C	E	C	C	C	C	C	C	C	C	C	C	C	C	C	C	C
Ammonia, anhydrous <sup>1</sup>	C	U	U	C	-	E	E	E	E	U	-	-	E	U	E	E	E	E	E	E	E	E	E	E	E	E	E	E	E	E
Ammonia, aqueous	G	G	U	C	-	E	E	E	E	U	-	-	E	U	E	E	E	E	E	E	E	E	E	E	E	E	E	E	E	E
Ammonium carbonate, 10% aq	U	E	C	U	-	E	U	E	E	U	-	C	U	C	C	C	C	C	C	C	C	C	C	C	C	C	C	C	C	C
Ammonium chloride, 10% aq	E	E	C	U	-	E	E	E	E	U	-	-	U	C	U	C	C	C	C	C	C	C	C	C	C	C	C	C	C	C
Ammonium hydroxide, 10% aq	U	E	U	U	-	E	C	C	E	C	U	U	G	U	C	C	C	C	C	C	C	C	C	C	C	C	C	C	C	C
Ammonium nitrate, 10% aq	E	E	C	U	-	E	E	G	E	U	G	C	G	U	G	G	U	G	G	U	G	G	U	G	G	U	G	G	U	G

- = Excellent – Fluid has little or no effect.
- = Good – Fluid has minor to moderate effect.
- = Conditional – Service conditions should be described to Danfoss for determination of suitability for application.
- = Unsatisfactory

Fluid	Hose						Seals						Metal																		
	Nitrile		PTFE		Thermoplastic elastomer		Buna-N		Neoprene		EPR		Viton*		Urethane		Hytrell†		Steel		Brass		Stainless steel		Aluminum		Monel‡				
	1	2	3	4	5	6	1	2	3	4	5	6	1	2	3	4	5	6	1	2	3	4	5	6	1	2	3	4	5	6	
Ammonium phosphate, 10% aq	E	E	C	U	-	E	E	E	E	-	G	C	U	C	G	U	G	U	G	U	G	U	G	U	G	U	G	U	G		
Ammonium sulfate/sulfide, 10% aq	E	E	C	U	-	E	E	E	E	U	G	C	U	U	G	U	U	G	U	G	U	G	U	G	U	G	U	G	U	G	
Amyl acetate	U	E	U	U	-	E	U	U	G	U	U	U	E	E	E	E	E	E	E	E	E	E	E	E	E	E	E	E	E	E	
Amyl alcohol	G	E	E	C	-	E	G	C	E	G	C	E	G	C	E	G	G	E	U	G	G	E	U	G	U	G	U	G	U	G	
Aniline, aniline oil	U	E	U	U	-	E	U	U	G	U	U	U	E	U	E	U	E	U	E	G	G	E	U	G	U	G	U	G	U	G	
Aniline dyes	U	E	U	U	-	E	U	G	G	G	U	U	U	C	G	C	G	C	C	C	C	C	C	C	C	C	C	C	C	C	
Asphalt, < 200°F	C	E	G	G	-	U	G	C	U	E	G	G	E	G	E	E	E	E	E	E	E	E	E	E	E	E	E	E	E	E	
IRM 901	E	E	E	E	-	U	E	E	C	E	E	E	E	E	E	E	E	E	E	E	E	E	E	E	E	E	E	E	E	E	
ASTM #2	E	E	E	E	-	U	E	G	U	E	G	E	E	E	E	E	E	E	E	E	E	E	E	E	E	E	E	E	E	E	
IRM 903	E	E	E	E	-	U	E	G	U	E	G	E	E	E	E	E	E	E	E	E	E	E	E	E	E	E	E	E	E	E	
Automatic trans. fluid <sup>2</sup>	G	E	G	G	-	U	E	G	U	E	C	G	E	E	E	E	E	E	E	E	E	E	E	E	E	E	E	E	E	E	
Barium hydroxide, 105 aq	E	E	G	C	-	E	E	E	E	E	E	G	C	U	G	G	U	G	U	G	U	G	U	G	U	G	U	G	U	G	
Barium sulfide, 10% aq	E	E	C	C	-	E	E	E	E	E	G	C	C	U	G	U	G	U	G	U	G	U	G	U	G	U	G	U	G	U	
Benzene, benzol	U	E	U	U	-	U	U	U	U	E	U	C	G	E	E	E	E	E	E	E	E	E	E	E	E	E	E	E	E	E	
Benzoic acid	U	E	C	U	-	U	U	U	E	E	C	C	U	G	G	G	G	G	G	G	G	G	G	G	G	G	G	G	G	G	
Benzyl alcohol	U	E	C	U	-	E	U	G	G	E	C	C	E	G	E	G	E	E	E	E	E	E	E	E	E	E	E	E	E	E	
Biodiesel (<180°F)	G	E	G	C	-	U																									
Biodiesel (>180°F)	C	E	U	U	-	U																									
Black sulfate liquor	G	E	C	C	-	E	C	C	C	E	U	C	E	C	E	C	E	C	E	C	E	C	E	C	E	C	E	C	E	C	
Blast furnace gas	C	U	C	G	-	U	U	U	U	E	U	C	E	C	E	C	E	C	E	C	E	C	E	C	E	C	E	C	E	C	
Borax, 10% aq	E	E	G	C	-	E	G	G	E	E	G	E	E	E	E	E	E	E	E	E	E	E	E	E	E	E	E	E	E	E	
Boric acid, 10% aq	E	E	C	E	-	E	G	G	G	E	G	G	U	G	C	C	C	C	C	C	C	C	C	C	C	C	C	C	C	C	
Brine	G	E	C	C	-	C	E	G	E	E	G	C	U	G	G	U	G	G	U	G	G	U	G	G	U	G	G	U	G	G	
Bromine, dry	U	E	U	U	-	U	U	U	U	E	U	U	C	U	C	C	C	C	C	C	C	C	C	C	C	C	C	C	C	C	
Butane <sup>1</sup>	LPG approved hose only						-	E	C	U	E	-	-	E	E	E	E	E	E	E	E	E	E	E	E	E	E	E	E	E	E
Butyl acetate	U	E	U	U	-	E	U	U	G	U	U	C	E	E	E	E	E	E	E	E	E	E	E	E	E	E	E	E	E	E	
Butyl alcohol	E	E	G	G	-	C	E	E	G	E	G	G	G	G	G	G	G	G	G	G	G	G	G	G	G	G	G	G	G	G	G

Fluid compatibility

This chart is intended for reference use only. The information in this chart pertains strictly to material compatibility and is not intended to be used as an application guide. For information on specific applications not included in this catalog, please contact Danfoss.

\*Viton is a trademark of The Chemours Company FC, LLC.  
 †Hytrell is a registered trademark of E.I. du Pont.  
 ‡Monel is a registered trademark of Special Metals Corporation group of Companies.  
 Note 1 - Rubber-covered hose must be perforated to allow gas to escape.  
 Note 2 - Due to the widely different additives in these fluids, testing should be done on the actual fluid being considered.

Fluid	Hose						Seals						Metal																
	Nitrile		PTFE		Thermoplastic elastomer		Buna-N		Neoprene		EPR		Viton*		Urethane		Hytrell†		Steel		Brass		Stainless steel		Aluminum		Monel‡		
	1	2	3	4	5	6	1	2	3	4	5	6	1	2	3	4	5	6	1	2	3	4	5	6	1	2	3	4	5
Butyl cellosolve	U	E	U	U	-	E	U	U	G	U	U	C	E	E	E	E	E	E	E	E	E	E	E	E	E	E	E	E	
Butylene (butene) <sup>1</sup>	C	E	-	C	-	U	C	U	U	E	U	-	E	E	E	E	E	E	E	E	E	E	E	E	E	E	E	E	
Butyl stearate	U	E	-	U	-	U	G	U	U	E	-	-	G	G	G	G	G	G	G	G	G	G	G	G	G	G	G	G	
Butyraldehyde	U	E	-	U	-	E	U	U	G	U	U	-	E	E	E	E	E	E	E	E	E	E	E	E	E	E	E	E	
	G	E	C	C	-	E	G	G	E	U	U	C	G	G	G	C	G	G	G	C	G	G	G	C	G	G	G	G	
Calcium bisulfate, 10% aq	U	E	C	G	-	U	E	E	U	E	G	G	U	C	C	U	U	U	U	U	U	U	U	U	U	U	U	U	
Calcium chloride, 10% aq	E	E	E	C	-	E	E	E	E	E	E	E	E	G	G	G	C	G	G	C	C	C	C	C	C	C	C	C	
Calcium hydroxide, 10% aq	E	E	C	C	-	E	E	E	E	E	U	C	G	G	G	U	G	G	G	U	G	G	U	G	G	G	G	G	
Calcium hydroxide, 10% aq	C	E	C	U	-	E	U	U	E	E	U	C	U	G	C	U	U	U	U	U	U	U	U	U	U	U	U	U	
Calcium nitrate, 10% aq	E	E	E	G	-	E	E	E	E	E	E	E	E	G	G	G	G	G	G	G	G	G	G	G	G	G	G	G	
Carbitol	G	E	G	C	-	G	G	G	G	U	G	E	E	E	E	E	E	E	E	E	E	E	E	E	E	E	E	E	
Carbolic acid (phenol)	U	E	U	U	-	C	U	U	G	E	U	U	U	E	E	-	-	-	-	-	-	-	-	-	-	-	-	-	
Carbonic acid	C	E	C	U	-	E	G	E	E	C	C	U	C	E	G	E	E	E	E	E	E	E	E	E	E	E	E	E	
Carbon dioxide, dry gas <sup>1</sup>	E	E	E	E	-	E	G	G	E	E	G	E	E	E	E	E	E	E	E	E	E	E	E	E	E	E	E	E	
Carbon disulfide	U	E	U	U	-	U	U	U	U	E	C	C	G	G	G	E	G	G	G	E	G	G	E	G	E	G	E	G	
Carbon monoxide <sup>1</sup>	E	E	E	E	-	E	G	G	E	E	G	E	E	E	E	E	E	E	E	E	E	E	E	E	E	E	E	E	
Carbon tetrachloride	U	E	U	U	-	U	U	U	U	E	U	U	U	G	G	U	E	E	E	E	E	E	E	E	E	E	E	E	
Castor oil	E	E	G	E	-	G	E	E	G	E	G	G	E	E	E	E	E	E	E	E	E	E	E	E	E	E	E	E	
Cellosolve acetate	U	E	U	U	-	E	U	U	G	U	U	U	U	U	E	G	E	E	E	E	E	E	E	E	E	E	E	E	
China wood oil (tung Oil)	E	E	C	C	-	U	G	G	U	E	U	C	E	G	E	E	E	E	E	E	E	E	E	E	E	E	E	E	
Chlorine <sup>1</sup>	U	G	U	U	-	U	U	U	U	G	U	U	C	C	C	C	C	C	C	C	C	C	C	C	C	C	C	C	
Chloroacetic acid	U	E	U	U	-	E	U	U	G	U	U	U	U	U	U	U	U	U	U	U	U	U	U	U	U	U	U	U	

- = Excellent – Fluid has little or no effect.
- = Good – Fluid has minor to moderate effect.
- = Conditional – Service conditions should be described to Danfoss for determination of suitability for application.
- = Unsatisfactory

Fluid	Hose						Seals						Metal																
	Nitrile		PTFE		Thermoplastic elastomer		Buna-N		Neoprene		EPR		Viton*		Urethane		Hytrell†		Steel		Brass		Stainless steel		Aluminum		Monel‡		
	1	2	3	4	5	6	1	2	3	4	5	6	1	2	3	4	5	6	1	2	3	4	5	6	1	2	3	4	5
Chloroacetone	U	E	U	U	-	E	U	U	E	U	U	U	G	U	U	U	G	G	G	U	G	G	G	U	G	G	G		
Chlorobenzene	U	E	U	U	-	U	U	U	U	G	U	U	G	U	U	G	G	G	G	U	G	G	G	G	G	G	G	G	
Chloroform	U	E	U	U	-	U	U	U	U	E	U	U	G	U	U	G	G	G	G	U	G	G	G	G	G	G	G	G	
O-Chlorophenol	U	E	U	U	-	U	U	U	U	E	U	U	G	U	U	G	G	G	U	G	G	G	U	G	G	G	G	G	
Chlosulfonic acid	U	U	U	U	-	U	U	U	U	U	U	U	U	U	U	U	G	U	G	U	G	G	C	G	C	G	C	C	
Chrome plating solution	U	E	-	U	-	U	U	U	G	E	U	-	C	U	U	U	C	U	U	U	U	U	U	U	U	U	U	U	
	U	E	-	U	-	C	U	U	C	E	U	-	C	U	U	U	U	U	U	U	U	U	U	U	U	U	U	U	
Citric acid	G	E	C	G	-	E	E	E	E	E	E	E	E	C	C	C	C	C	C	C	C	C	C	C	C	C	C	C	
Coke oven gas	U	E	-	U	-	U	U	U	U	E	U	-	E	C	E	U	E	E	E	U	E	E	U	U	U	U	U	U	
Copper chloride, 10% aq	E	E	E	G	-	E	E	E	E	E	G	E	U	U	U	U	U	U	U	U	U	U	U	U	U	U	U	U	
Copper cyanide, 10% aq	E	E	-	G	-	E	E	E	E	E	E	-	E	U	G	U	G	U	G	U	G	U	G	U	G	U	G	G	
Copper sulfate, 10% aq	E	E	G	G	-	E	E	E	E	E	G	G	U	C	G	U	C	G	U	G	U	G	U	G	U	G	U	G	
Cotton seed Oil	E	E	E	G	-	C	E	G	C	E	E	E	E	E	E	E	E	E	E	E	E	E	E	E	E	E	E	E	
Creosote (coal tar)	G	E	U	G	-	U	G	C	U	E	U	U	E	C	E	E	C	E	E	C	E	E	E	E	E	E	E	E	
Crude oil	G	E	C	E	-	U	E	G	U	E	G	C	G	U	G	U	G	U	G	U	G	U	U	U	U	U	U	U	
Cyclohexanol	C	E	C	G	-	U	E	G	U	E	C	C	E	E	E	C	E	E	E	C	E	E	C	E	E	E	E	E	
Cyclohexanone	U	E	C	U	-	G	U	U	G	U	U	G	G	E	E	E	E	E	E	E	E	E	E	E	E	E	E	E	
	E	E	C	G	-	E	E	E	E	E	C	C	G	E	E	E	E	E	E	E	E	E	E	E	E	E	E	E	
Diacetone alcohol (acetol)	U	E	U	U	-	E	U	U	E	U	C	C	E	E	E	E	E	E	E	E	E	E	E	E	E	E	E	E	
Dibenzyl ether	U	E	-	U	-	G	U	U	G	U	-	-	G	G	G	G	G	G	G	U	G	G	G	G	G	G	G	G	
Diesel oil <sup>2</sup>	G	E	C	G	-	U	E	C	U	E	C	C	E	E	E	E	E	E	E	E	E	E	E	E	E	E	E	E	
Diethylamine	C	E	-	C	-	C	G	G	G	U	-	-	E	U	E	-	E	U	E	-	E	-	E	-	E	-	E	-	
Diocetyl phthalate (DOP)	U	E	C	C	-	G	U	U	G	C	C	E	E	E	E	E	E	E	E	E	E	E	E	E	E	E	E	E	
Dowtherm A&E	U	E	-	U	-	U	U	U	U	E	-	-	G	U	E	E	E	E	E	E	E	E	E	E	E	E	E	E	
	E	E	C	G	-	E	E	E	E	E	C	C	E	E	E	E	E	E	E	E	E	E	E	E	E	E	E	E	
Ethyl acetate	U	E	C	U	-	G	U	U	G	U	C	C	E	E	E	E	E	E	E	E	E	E	E	E	E	E	E	E	
Ethyl benzene	U	E	-	U	-	U	U	U	U	E	U	-	E	G	G	G	E	E	E	E	E	E	E	E	E	E	E	E	
Ethyl cellulose	G	E	U	U	-	G	G	G	G	U	C	C	E	G	G	G	E	E	E	E	E	E	E	E	E	E	E	E	
Ethyl chloride	C	E	U	U	-	U	U	U	U	E	U	U	E	E	E	E	E	E	E	E	E	E	E	E	E	E	E	E	
Ethylene dichloride	U	E	U	U	-	U	U	U	U	G	U	U	G	U	U	G	C	G	C	G	G	G	G	G	G	G	G	G	
Ethylene glycol	E	E	C	G	-	E	E	E	E	E	C	C	U	G	E	E	E	E	E	E	E	E	E	E	E	E	E	E	

This chart is intended for reference use only. The information in this chart pertains strictly to material compatibility and is not intended to be used as an application guide. For information on specific applications not included in this catalog, please contact Danfoss.

\*Viton is a trademark of The Chemours Company FC, LLC.  
 †Hytrell is a registered trademark of E.I. du Pont.  
 ‡Monel is a registered trademark of Special Metals Corporation group of Companies.  
 Note 1 - Rubber-covered hose must be perforated to allow gas to escape.  
 Note 2 - Due to the widely different additives in these fluids, testing should be done on the actual fluid being considered.

Fluid compatibility

Fluid	Hose						Seals						Metal																	
	Nitrile		PTFE		Thermoplastic elastomer		Buna-N		Neoprene		EPR		Viton*		Urethane		Hytrell†		Steel		Brass		Stainless steel		Aluminum		Monel‡			
	1	2	3	4	5	6	1	2	3	4	5	6	1	2	3	4	5	6	1	2	3	4	5	6	1	2	3	4	5	6
	E	E	-	G	-	E	E	G	E	E	-	-	U	U	U	U	U	U	U	U	U	U	U	U	U	U	U	U	U	U
Ferric nitrate, 10% aq	E	E	C	E	-	E	E	E	E	E	C	C	U	U	G	U	U	U	U	U	U	U	U	U	U	U	U	U	U	U
Ferric sulfate, 10% aq	E	E	C	E	-	E	G	G	G	E	C	C	U	U	E	U	U	U	U	U	U	U	U	U	U	U	U	U	U	
Formaldehyde	U	E	C	U	-	E	C	C	G	G	C	C	E	E	E	G	G	E	E	E	E	E	E	E	E	E	E	E	E	
Formic acid	G	E	U	C	-	E	C	G	E	U	U	U	U	U	C	C	C	C	C	C	C	C	C	C	C	C	C	C	C	
Fuel oil	E	E	G	E	-	U	E	G	U	E	G	G	E	E	E	E	E	E	E	E	E	E	E	E	E	E	E	E	E	
Furfural	U	E	-	U	-	G	C	C	G	U	U	-	G	G	G	G	G	G	G	G	G	G	G	G	G	G	G	G	G	
	G	E	-	C	-	G	G	G	G	E	U	-	U	-	G	C	G	G	G	G	G	G	G	G	G	G	G	G	G	
Gasoline <sup>2</sup>	G	E	E	G	-	U	E	C	U	E	E	E	E	E	E	E	E	E	E	E	E	E	E	E	E	E	E	E	E	
Gasohol <sup>2</sup>	G	E	G	C	-	U	G	G	U	E	E	E	E	E	E	E	E	E	E	E	E	E	E	E	E	E	E	E	E	
Glycerine/ Glycerol	E	E	E	E	-	E	E	E	E	E	G	E	E	E	E	E	E	E	E	E	E	E	E	E	E	E	E	E	E	
Green sulfate liquor	G	E	-	U	-	E	G	G	E	E	-	-	U	U	E	U	U	U	U	U	U	U	U	U	U	U	U	U	U	
	E	G	C	E	-	E	E	E	E	E	E	E	E	E	E	E	E	E	E	E	E	E	E	E	E	E	E	E	E	
Heptane	E	E	E	C	-	U	E	G	U	E	G	G	E	E	E	E	E	E	E	E	E	E	E	E	E	E	E	E	E	
Hexaldehyde	U	E	-	U	-	E	U	G	G	U	U	-	G	G	E	E	G	E	E	E	E	E	E	E	E	E	E	E	E	
Hexane	E	E	E	E	-	U	E	G	U	E	G	G	E	E	E	E	E	E	E	E	E	E	E	E	E	E	E	E	E	
Hydraulic oils <sup>2</sup>																														
Ester blend	C	E	C	G	-	C	E	U	U	E	U	E	E	E	E	E	E	E	E	E	E	E	E	E	E	E	E	E	E	
Phos. Ester/ petroleum blend	U	E	C	U	-	U	U	U	U	C	U	G	E	E	E	E	E	E	E	E	E	E	E	E	E	E	E	E	E	
Silicone oils	E	E	E	E	-	E	E	E	E	E	E	E	E	E	E	E	E	E	E	E	E	E	E	E	E	E	E	E	E	
Straight petroleum base	E	E	E	E	-	U	E	G	U	E	E	E	E	E	E	E	E	E	E	E	E	E	E	E	E	E	E	E	E	
Straight phosphate ester	U	E	C	U	-	E	U	U	G	C	U	G	E	E	E	E	E	E	E	E	E	E	E	E	E	E	E	E	E	
Water glycol	E	E	C	G	-	E	E	E	E	E	C	C	E	E	E	E	G	E	E	E	E	E	E	E	E	E	E	E	E	
Water petroleum emulsion	E	E	C	G	-	U	E	G	U	E	C	C	E	E	E	G	E	E	E	E	E	E	E	E	E	E	E	E	E	
Hydrobromic acid	U	E	U	U	-	G	U	U	E	E	U	U	U	U	E	U	U	U	U	U	U	U	U	U	U	U	U	U	U	
Hydrochloric acid, cold	U	E	U	U	-	G	U	U	G	E	U	U	U	U	U	U	U	U	U	U	U	U	U	U	U	U	U	U	U	
Hydrocyanic acid	C	E	-	U	-	E	C	C	E	E	-	-	E	E	G	E	G	E	E	E	E	E	E	E	E	E	E	E	E	
Hydrofluoric acid	U	E	U	U	-	U	U	U	C	U	U	U	U	U	U	U	U	U	U	U	U	U	U	U	U	U	U	U	U	
Hydrofluorosilic acid	E	E	-	G	-	G	G	G	E	E	-	-	U	U	U	U	U	U	U	U	U	U	U	U	U	U	U	U	U	
Hydrogen <sup>1</sup>	G	C	G	G	-	E	E	E	E	E	E	E	E	E	E	E	E	E	E	E	E	E	E	E	E	E	E	E	E	
Hydrogen peroxide	C	E	G	C	-	G	G	G	E	E	G	G	U	U	U	U	U	U	U	U	U	U	U	U	U	U	U	U	U	
Hydrogen sulfide, dry	C	C	C	U	-	E	U	G	E	U	-	G	E	E	G	G	G	E	E	E	E	E	E	E	E	E	E	E	E	
Isocyanate	U	E	U	U	-	U	U	U	G	E	U	U	U	U	G	-	-	G	-	-	-	-	-	-	-	-	-	-	-	
Iso octane	G	E	E	G	-	U	E	G	U	E	G	E	E	E	E	E	E	E	E	E	E	E	E	E	E	E	E	E	E	
Isopropyl acetate	U	E	C	U	-	C	U	U	G	U	U	C	E	-	E	E	E	E	E	E	E	E	E	E	E	E	E	E	E	
Isopropyl alcohol	G	E	C	G	-	E	G	G	E	E	U	C	E	E	E	E	E	E	E	E	E	E	E	E	E	E	E	E	E	
Isopropyl ether	G	E	-	C	-	U	G	U	U	U	C	-	G	G	G	-	-	G	G	-	-	-	-	-	-	-	-	-	-	
	E	E	G	E	-	U	E	U	U	E	U	G	E	E	E	E	E	E	E	E	E	E	E	E	E	E	E	E	E	
	U	E	U	U	-	E	U	U	U	U	U	G	U	E	E	E	E	E	E	E	E	E	E	E	E	E	E	E	E	
Lime sulfur	U	E	C	U	-	E	U	E	E	E	C	C	G	U	G	-	U	U	U	U	U	U	U	U	U	U	U	U	U	
Linseed oil	E	E	G	G	-	U	E	G	U	E	G	G	E	E	E	E	E	E	E	E	E	E	E	E	E	E	E	E	E	
LPG <sup>1</sup>	LPG approved hose only						E	G	U	E	-	-	E	E	E	E	E	E	E	E	E	E	E	E	E	E	E	E	E	
Lubricating oils <sup>2</sup>	See hydraulic oils						See hydraulic oils						See hydraulic oils																	
	E	E	C	E	-	E	E	E	E	E	C	C	E	C	C	G	G	E	E	E	E	E	E	E	E	E	E	E	E	
Magnesium hydroxide, 10% aq	G	E	C	G	-	E	G	G	E	E	C	C	E	E	E	E	E	E	E	E	E	E	E	E	E	E	E	E	E	
Magnesium sulfate, 10% aq	E	E	C	E	-	E	E	E	E	E	C	C	E	E	E	E	E	E	E	E	E	E	E	E	E	E	E	E	E	
Maleic acid	U	E	C	C	-	G	U	U	U	E	C	C	E	G	G	G	G	E	E	E	E	E	E	E	E	E	E	E	E	
Maleic anhydride	U	E	C	U	-	C	U	U	U	E	C	C	G	U	E	G	E	E	E	E	E	E	E	E	E	E	E	E	E	
Malic acid	G	E	-	G	-	U	G	G	U	G	-	-	U	-	E	G	E	E	E	E	E	E	E	E	E	E	E	E	E	
Mercuric chloride	G	E	E	G	-	G	E	E	E	E	E	E	U	U	U	U	U	U	U	U	U	U	U	U	U	U	U	U	U	
Mercury	E	E	E	E	-	E	E	E	E	E	E	E	E	E	E	E	E	E	E	E	E	E	E	E	E	E	E	E	E	
Methanol	E	E	C	E	-	E	G	G	E	U	C	C	G	G	E	C	E	E	E	E	E	E	E	E	E	E	E	E	E	

= Excellent – Fluid has little or no effect.  
 = Good – Fluid has minor to moderate effect.  
 = Conditional – Service conditions should be described to Danfoss for determination of suitability for application.  
 = Unsatisfactory

Fluid compatibility

This chart is intended for reference use only. The information in this chart pertains strictly to material compatibility and is not intended to be used as an application guide. For information on specific applications not included in this catalog, please contact Danfoss.

\*Viton is a trademark of The Chemours Company FC, LLC.  
 †Hytrell is a registered trademark of E.I. du Pont.  
 ‡Monel is a registered trademark of Special Metals Corporation group of Companies.  
 Note 1 - Rubber-covered hose must be perforated to allow gas to escape.  
 Note 2 - Due to the widely different additives in these fluids, testing should be done on the actual fluid being considered.

Fluid	Hose						Seals						Metal					
	Nitrile 1	PTFE 2	Thermoplastic elastomer 3	CPE 4	Special application hose 5	EPDM 6	Buna-N Neoprene EPR	Viton* Urethane Hytrell†	Steel	Brass	Stainless steel Aluminum	Monel‡	Steel	Brass	Stainless steel Aluminum	Monel‡		
Methyl bromide	C	E	U	U	-	U	G	U	U	E	U	U	E	E	G	U	E	
Methyl chloride	U	E	U	U	-	U	U	U	E	U	U	U	E	E	E	U	G	
Methyl butyl ketone	U	E	U	U	-	E	U	U	E	U	C	C	E	E	E	-	E	
Methyl ethyl ketone	U	E	U	U	-	E	U	U	E	U	U	G	G	G	G	G	G	
Methylene chloride	U	E	U	U	-	U	U	U	G	U	U	G	G	G	G	G	G	
Methyl isobutyl ketone	U	E	U	U	-	E	U	U	U	U	U	G	G	G	G	G	G	
Methyl isopropyl ketone	U	E	U	C	-	E	U	U	U	U	U	G	G	G	G	G	G	
Methyl salicylate	U	E	-	U	-	C	U	U	C	U	-	-	E	G	G	E	G	
MIL-L-2104	E	E	E	E	-	U	E	G	U	E	E	E	E	E	E	-	E	
MIL-H-5606	E	E	E	E	-	U	E	G	U	E	E	E	E	E	E	E	E	
MIL-H-6083	E	E	E	E	-	U	E	E	U	E	E	E	E	E	E	-	E	
MIL-L-7808	G	E	G	G	-	U	G	U	U	E	G	G	G	G	E	-	-	
MIL-L-23699	E	E	-	G	-	U	G	U	U	E	-	-	E	E	E	E	E	
MIL-H-46170	G	E	-	G	-	C	E	G	U	E	-	-	E	E	E	-	E	
MIL-H-83282	G	E	-	G	-	U	E	U	U	E	-	-	E	E	E	-	E	
Mineral oils	E	E	G	E	-	U	E	G	U	E	G	G	E	E	E	E	E	
	C	E	G	E	-	U	C	U	U	E	C	G	-	-	-	-	-	
Naphthalene	U	E	U	U	-	U	U	U	E	C	G	E	G	E	G	G	G	
Naphthenic acid	U	E	-	U	-	U	C	U	U	E	-	-	-	G	E	G	G	
Natural gas <sup>1</sup>	LPG approved hose only						E	E	U	E	-	-	G	G	G	G	G	
Nickel acetate, 10% aq	G	C	U	G	-	E	C	E	G	U	U	G	C	E	G	E	E	
Nickel chloride, 10% aq	E	E	U	E	-	E	E	G	E	E	U	U	U	G	U	G	G	
Nickel sulfate, 10% aq	E	E	U	E	-	E	E	E	E	U	U	U	G	G	U	G	G	
Nitric acid, to 10%	U	E	U	U	-	G	U	U	E	U	C	U	U	E	U	U	U	
Nitric acid, over 10%	U	C	U	U	-	U	U	U	G	U	U	U	U	E	C	U	U	
Nitrobenzene	U	E	U	U	-	E	U	U	G	U	U	E	G	E	E	E	E	

- = Excellent – Fluid has little or no effect.
- = Good – Fluid has minor to moderate effect.
- = Conditional – Service conditions should be described to Danfoss for determination of suitability for application.
- = Unsatisfactory

Fluid	Hose						Seals						Metal					
	Nitrile 1	PTFE 2	Thermoplastic elastomer 3	CPE 4	Special application hose 5	EPDM 6	Buna-N Neoprene EPR	Viton* Urethane Hytrell†	Steel	Brass	Stainless steel Aluminum	Monel‡	Steel	Brass	Stainless steel Aluminum	Monel‡		
Nitrogen <sup>1</sup>	E	E	E	E	-	E	E	E	E	E	E	E	E	E	E	E	E	
Octyl alcohol	C	E	E	U	-	U	E	E	E	E	E	E	E	E	E	E	E	
Oleic acid	G	E	G	U	-	U	U	U	C	G	G	E	C	E	G	C	G	
Ortho-dichlorobenzene	U	E	-	U	-	U	U	U	E	-	-	G	G	G	G	G	G	
Oxalic acid, 10% aq	C	E	C	C	-	E	G	G	E	E	C	C	U	C	C	C	C	
Oxygen <sup>1</sup>	U	U	U	U	-	E	-	-	-	-	-	-	G	G	G	G	G	
	E	E	E	E	-	G	E	G	G	E	-	E	G	-	E	G	G	
Para-dichlorobenzene	U	E	-	U	-	U	U	U	E	-	-	G	G	G	G	G	G	
Pentane <sup>1</sup>	Lpg approved hose only						E	E	U	E	U	G	G	G	G	E	G	
Perchloric acid	U	E	U	U	-	G	E	G	G	E	U	U	U	U	U	U	U	
Per-chloroethylene	U	E	U	U	-	U	U	U	E	U	U	C	G	G	G	E	E	
Petroleum base oils	G	E	E	E	-	U	E	G	U	E	E	E	E	E	E	E	E	
Phenol (carbolic acid)	U	E	U	U	-	U	U	U	G	E	U	U	E	E	E	E	G	
Phosphate ester <sup>2</sup>	U	E	C	U	-	E	U	U	G	C	U	G	E	E	E	E	E	
Phosphoric acid 20%	U	E	U	U	-	E	U	U	G	E	U	U	U	E	U	C	E	
Phosphorous trichloride	U	E	U	U	-	E	U	U	E	E	U	U	C	U	C	E	E	
Potassium Acetate, 10% aq	G	E	-	G	-	E	G	G	E	U	-	-	C	G	C	U	G	
Potassium chloride, 10% aq	E	E	E	E	-	E	E	E	E	E	E	E	E	C	E	U	G	
Potassium cyanide, 10% aq	E	E	E	G	-	E	E	E	E	E	E	E	C	U	G	U	C	
Potassium dichromate, 10% aq	E	E	E	E	-	E	E	E	E	E	E	E	C	C	C	C	C	
Potassium hydroxide, to 10%	G	E	C	C	-	E	G	G	E	G	C	C	G	G	G	U	E	
Potassium hydroxide, over 10%	C	E	U	C	-	E	C	C	E	U	U	U	G	G	G	U	E	
Potassium nitrate, 10% aq	E	E	E	E	-	E	E	E	E	E	E	E	G	E	G	G	-	
Potassium sulfate, 10% aq	E	E	E	E	-	E	E	E	E	E	E	E	-	-	-	-	-	
Propane <sup>1</sup> (liquefied)	LPG approved hose only						C	-	-	-	-	-	E	E	E	E	E	

This chart is intended for reference use only.  
 The information in this chart pertains strictly to material compatibility and is not intended to be used as an application guide. For information on specific applications not included in this catalog, please contact Danfoss.

\*Viton is a trademark of The Chemours Company FC, LLC.  
 †Hytrell is a registered trademark of E.I. du Pont.  
 ‡Monel is a registered trademark of Special Metals Corporation group of Companies.  
 Note 1 - Rubber-covered hose must be perforated to allow gas to escape.  
 Note 2 - Due to the widely different additives in these fluids, testing should be done on the actual fluid being considered.

Fluid	Hose						Seals						Metal																
	Nitrile		PTFE		Thermoplastic elastomer		Buna-N		Neoprene		EPR		Viton*		Urethane		Hytrell†		Steel		Brass		Stainless steel		Aluminum		Monel‡		
	1	2	3	4	5	6	1	2	3	4	5	6	1	2	3	4	5	6	1	2	3	4	5	6	1	2	3	4	5
Propyl acetate	U	E	-	U	-	G	U	U	G	U	-	-	E	E	E	E	E	E	E	E	E	E	E	E	E	E	E	E	
Propyl alcohol	E	E	U	E	-	E	E	E	E	E	U	U	E	E	E	E	E	E	E	E	E	E	E	E	E	E	E	E	
Propylene <sup>1</sup>	U	E	-	U	-	U	U	U	U	E	-	-	E	E	E	E	E	E	E	E	E	E	E	E	E	E	E	E	
	E	-	G	C	-	C	G	E	C	E	E	E	E	E	E	E	E	E	E	E	E	E	E	E	E	E	E	E	
Refrigerant R-131	E	-	G	C	-	G	G	E	C	E	E	E	E	E	E	E	E	E	E	E	E	E	E	E	E	E	E	E	
Refrigerant R-221	U	C	U	U	-	E	U	E	C	U	U	U	E	E	E	E	E	E	E	E	E	E	E	E	E	E	E	E	
Refrigerant R-134a <sup>1</sup>	C	C	U	U	-	E	E	C	U	U	U	E	E	E	E	E	E	E	E	E	E	E	E	E	E	E	E	E	
	G	E	E	G	-	E	E	E	E	E	U	E	G	G	G	G	G	G	G	G	G	G	G	G	G	G	G	G	
Silicone oils	G	E	E	G	-	E	E	E	E	E	E	E	E	E	E	E	E	E	E	E	E	E	E	E	E	E	E	E	
Soap (water solutions)	E	E	C	E	-	E	E	E	E	E	C	C	E	E	E	E	E	E	E	E	E	E	E	E	E	E	E	E	
Sodium acetate, 10% aq	G	U	-	G	-	E	G	G	E	U	-	-	E	E	G	E	E	E	E	E	E	E	E	E	E	E	E	E	
Sodium Bicarbonate, 10% aq	E	E	E	E	-	E	E	E	E	E	E	E	E	E	E	E	E	E	E	E	E	E	E	E	E	E	E	E	
Sodium borate, 10% aq	E	E	E	E	-	E	E	E	E	E	E	E	E	E	E	E	E	E	E	E	E	E	E	E	E	E	E	E	
Sodium carbonate, 10% aq	E	E	E	E	-	E	E	E	E	E	E	E	E	E	E	E	E	E	E	E	E	E	E	E	E	E	E	E	
Sodium chloride, 10% aq	E	E	E	G	-	E	E	E	E	E	E	E	U	C	C	C	E	E	E	E	E	E	E	E	E	E	E	E	
Sodium cyanide, 10% aq	E	E	E	E	-	E	E	E	E	E	E	E	E	-	C	U	U	U	U	U	U	U	U	U	U	U	U	U	
Sodium hydroxide, to 10%	C	E	G	C	-	E	U	G	E	E	G	G	C	C	C	U	C	C	C	C	C	C	C	C	C	C	C	C	
Sodium hydroxide, over 10%	U	E	C	U	-	E	U	U	G	E	C	C	C	C	C	U	U	U	U	U	U	U	U	U	U	U	U	U	
Sodium hypochlorite, 10% aq	C	E	C	G	-	G	C	C	E	C	C	C	U	U	U	U	U	U	U	U	U	U	U	U	U	U	U	U	
Sodium metaphosphate, 10% aq	E	E	E	E	-	E	E	E	E	E	E	E	E	E	E	E	E	E	E	E	E	E	E	E	E	E	E	E	

Fluid	Hose						Seals						Metal																
	Nitrile		PTFE		Thermoplastic elastomer		Buna-N		Neoprene		EPR		Viton*		Urethane		Hytrell†		Steel		Brass		Stainless steel		Aluminum		Monel‡		
	1	2	3	4	5	6	1	2	3	4	5	6	1	2	3	4	5	6	1	2	3	4	5	6	1	2	3	4	5
Sodium nitrate, 10% aq	G	E	E	G	-	E	G	G	E	-	E	E	E	E	E	E	E	E	E	E	C	E	E	E	E	E	E		
Sodium perborate, 10% aq	G	E	-	G	-	E	G	G	E	E	-	-	C	U	C	U	C	U	C	U	C	U	C	U	C	U	C		
Sodium peroxide, 10% aq	G	E	-	G	-	G	G	G	E	E	U	-	U	U	C	C	C	C	C	C	C	C	C	C	C	C	C		
Sodium phosphates, 10% aq	E	E	E	C	-	E	E	E	E	E	E	E	E	E	U	E	G	U	E	E	E	E	E	E	E	E	E		
Sodium silicate, 10% aq	E	E	E	G	-	E	E	E	E	E	E	E	E	E	E	E	E	E	E	E	E	E	E	E	E	E	E		
Sodium sulfate, 10% aq	E	E	E	G	-	E	E	E	E	E	E	E	E	E	E	E	E	E	E	E	C	G	G	G	G	G	G		
Sodium sulfide, 10% aq	E	E	E	G	-	E	E	E	E	E	E	E	E	E	E	E	E	E	E	E	C	U	C	U	G	E	E		
Sodium thiosulfate, 10% aq	G	E	E	G	-	E	G	E	E	E	E	E	E	U	U	C	G	E	E	E	E	E	E	E	E	E	E		
Soy bean oil	E	E	G	C	-	U	E	G	U	E	G	G	E	E	E	E	E	E	E	E	E	E	E	E	E	E	E		
Stannic chloride	G	E	C	G	-	E	E	G	E	E	C	C	U	U	U	U	U	U	U	U	U	U	U	U	U	U	U		
Steam <sup>1</sup> (up to 388°F)	U	E	U	U	-	G	U	U	C	C	U	U	E	E	E	E	E	E	E	E	E	E	E	E	E	E	E		
Stearic acid	G	E	G	G	-	G	G	G	E	G	G	C	C	E	C	E	E	E	E	E	E	E	E	E	E	E	E		
Stoddard solvent	G	E	U	C	-	U	E	G	U	E	U	U	E	E	E	E	E	E	E	E	E	E	E	E	E	E	E		
Styrene	U	E	U	U	-	U	U	U	U	G	U	U	E	E	E	E	E	E	E	E	E	E	E	E	E	E	E		
Sulfur, slurry	C	E	G	E	-	E	U	E	E	E	G	G	E	U	G	E	E	E	E	E	E	E	E	E	E	E	E		
Sulfur chloride, wet	U	E	-	U	-	U	U	U	E	-	-	G	-	G	G	U	G	U	G	U	G	U	G	U	G	U	G		
Sulfur dioxide, dry <sup>1</sup>	U	E	U	U	-	E	U	G	E	U	U	E	G	G	E	G	G	E	G	G	E	G	G	E	G	G	E		
Sulfuric acid, to 10%	U	E	U	U	-	E	U	G	U	E	C	C	U	G	C	-	E	E	E	E	E	E	E	E	E	E	E		
Sulfuric acid, over 10%	U	E	U	U	-	U	U	U	G	U	U	C	C	U	C	C	U	C	C	U	C	C	U	C	U	C	U		
Sulfurous acid	U	E	U	G	-	G	C	C	U	G	U	U	U	U	U	U	U	U	U	U	C	C	C	U	C	U	C		
	G	E	G	G	-	E	G	E	E	E	G	G	E	E	E	E	E	E	E	E	E	E	E	E	E	E	E		
Tar (Bituminous)	G	E	G	G	-	U	G	U	U	E	G	G	E	E	E	E	E	E	E	E	E	E	E	E	E	E	E		
Tartaric acid	E	E	G	E	-	G	E	G	G	E	G	G	U	C	C	E	E	E	E	E	E	E	E	E	E	E	E		
Tertiary butyl alcohol	G	E	G	E	-	G	G	G	E	G	G	G	G	G	G	G	G	G	G	G	G	G	G	G	G	G	G		
Titanium tetrachloride	U	E	-	U	-	U	C	U	U	E	-	-	E	U	G	U													
Toluene (toluol)	U	E	U	U	-	U	U	U	E	U	U	E	E	E	E	E	E	E	E	E	E	E	E	E	E	E	E		

- = Excellent – Fluid has little or no effect.
- = Good – Fluid has minor to moderate effect.
- = Conditional – Service conditions should be described to Danfoss for determination of suitability for application.
- = Unsatisfactory

Fluid compatibility

Fluid	Hose						Seals						Metal				
	Nitrile 1 2		PTFE 3		Thermoplastic elastomer 4 CPE 5 Special application hose 6 EPDM		Buna-N	Neoprene	EPR	Viton*	Urethane	Hytrell†	Steel	Brass	Stainless steel	Aluminum	Monel‡
Trichlorethylene	U	E	U	U	-	U	U	U	U	E	U	U	E	G	E	E	E
Tricresyl Phosphate	U	E	U	U	-	E	U	U	E	G	U	U	E	-	C	-	G
Triethanolamine	G	E	U	G	-	E	E	U	E	U	U	U	E	U	E	E	E
Tung Oil	E	E	C	C	-	U	G	G	U	E	U	C	E	G	E	E	E
Turpentine	E	E	G	G	-	U	G	U	U	E	G	G	G	G	G	G	G
Varnish	C	E	G	G	-	U	G	U	U	E	G	G	E	G	E	E	E
Vinyl Chloride	U	E	U	U	-	U	U	U	U	E	U	U	E	U	C	E	E
Water (to +150°F)	E	E	E	G	-	E	E	E	E	E	E	E	C	G	E	G	E
Water (+151°F to +200°F)	C	E	U	C	-	E	E	E	E	U	U	C	G	E	G	E	E
Water (+201°F to +350°F)	U	E	U	U	-	E	U	U	G	G	U	U	C	G	E	G	E
Water Glycol	E	E	C	E	-	E	E	E	E	E	C	C	E	E	E	G	E
Water Petroleum Emulsion <sup>2</sup>	E	E	C	C	-	U	E	G	U	E	C	C	C	E	E	G	E
Xylene	U	E	C	U	-	U	U	U	U	E	U	C	E	E	E	E	E
Zinc Chloride, 10% aq	E	E	E	E	-	E	E	E	E	E	E	E	U	U	C	G	G
Zinc Sulfate, 10% aq	E	E	-	E	-	E	E	E	E	E	-	-	U	C	G	C	G

- = Excellent – Fluid has little or no effect.
- = Good – Fluid has minor to moderate effect.
- = Conditional – Service conditions should be described to Danfoss for determination of suitability for application.
- = Unsatisfactory

This chart is intended for reference use only. The information in this chart pertains strictly to material compatibility and is not intended to be used as an application guide. For information on specific applications not included in this catalog, please contact Danfoss.

\*Viton is a trademark of The Chemours Company FC, LLC.

†Hytrell is a registered trademark of E.I. du Pont.

‡Monel is a registered trademark of Special Metals Corporation group of Companies.

Note 1 - Rubber-covered hose must be perforated to allow gas to escape.

Note 2 - Due to the widely different additives in these fluids, testing should be done on the actual fluid being considered.

## Hydraulic fluids & lubricating oils

The following charts are a representative list of fluids and manufacturers. The fluids are grouped under generic “family” heads and arranged alphabetically. Two maximum fluid temperature ratings are listed under designations of “H” and “LP”. The “H” designation is for hydraulic service up to the maximum rated operating pressure of any particular hose in the classification. The “LP” designation is for low-pressure service such as lubricating oil systems or low-pressure hydraulic return lines. The letter “U” in the box indicates unsatisfactory resistance to the fluid type. Fluid temperature ratings are predicated on maximum allowable ambient temperatures as follows:

### Classifications 1 and 3

(Nitrile and thermoplastic elastomer)

“H” fluid temp. ratings: +140°F ambient

“LP” fluid temp. ratings: +180°F ambient

### Classification 2 (PTFE)

“H” fluid temp. ratings: +400°F ambient

“LP” fluid temp. ratings: +400°F ambient

### Classification 4 (CPE)

“H” fluid temp. ratings: +160°F ambient

“LP” fluid temp. ratings: +250°F ambient

(If “H” fluid temperature is +225°F or less, allowable ambient temperature may be increased to +200°F)

**Caution:** The fluid manufacturer’s recommended maximum operating temperature for any specific name brand fluid should be scrupulously observed by the user. These recommended temperatures can vary widely between name brands of different fluid compositions, even though they fall into the same generic “family” of fluids. Exceeding the manufacturer’s recommended maximum temperature can result in fluid breakdown, producing by-products that are harmful to elastomeric products, as well as other materials in the system. If a manufacturer’s recommended maximum temperature for his specific fluid is lower than that for the hose rating, it should take precedence over the hose rating for service usage.



# Weatherhead

Fluid compatibility

## Hydraulic fluids & lubricating oils (continued)

### Water and petroleum oil emulsion (fr)

**Maximum fluid temperature recommendation.**

See caution on page 344 for maximum fluid temperatures and limiting ambient temperatures.

Hose classifications (see page 344)				
	1	2	3	4
H	+200°F	+250°F	+150°F	+200°F
LP	+200°F	+250°F	+150°F	+200°F

Aqualube	Masol fire resistant fluid
Astrol #587	Meltran FR 900
	Mine guard
Chevron FR Fluid D	Mobilmet S122
Chrysler L-705	
Citgo pacemaker invert FR fluid	Penn drake hydraqua fluid
Conoco FR hydraulic fluid	Permamul FR
	Puro FR fluid
	Pyrogard C
Dasco IFR	Pyrogard D
Duro FR-HD	
	Quintolubric 957 series
Fire resistant hydrafluid	Quintolubric 958 series
Fire resistant hydraulic Fluid B	
FR 3110 hydraulic fluid (invert)	Regent hydrolube #670
Fyre-safe W/O	
	Safoil hydraulic fluid anti-wear
Gulf R & D FR fluid	Sinclair Duro FR-HD
	Solvac 1535G
Houghto-safe 5046	Staysol FR
Houghto-safe 5046W	Sunsafe F
Hulsafe 500	
Hy-chock oil	Union FR fluid
Hydrasol A	Union soluble oil HD
Ironsides #814-A	Veedol auburn FRH
Irus fluid 905	Veedol auburn FRH Concentrate
Kutwell 40	

### Water and glycol solution

**Maximum fluid temperature recommendation.**

See caution on page 344 for maximum fluid temperatures and limiting ambient temperatures.

Hose classifications (see page 344)				
	1	2	3	4
H	+200°F	+250°F	+150°F	C
LP	+200°F	+250°F	+150°F	C

Chem-trend HF-18	Maxmul
Chem-trend HF-20	Maxmul FR
Chevron glycol FR fluids	Melsyn 200
Citgo glycol FR fluids	Melsyn glycol FR
Citgo glycol FR-20 XD	
Citgo pacemaker	Nyvac FR fluid
	Nyvac FR 200 fluid
	Nyvac 20 (WG)
Dasco FR 150	Nyvac 30 (WG)
Dasco FR 200	
Dasco FR 200 B	
Dasco FR 310	Park water glycol hydraulic fluid
	Pennzoil fluid FR 2X
Fyrguard 150	
Fyrguard 200	
Fyre-Safe 225	Quintolubric 700 series
Gulf FR fluid G-200	Santosafe W/G 15
Gulf FR fluid – G series	Santosafe W/G 20
	Santosafe W/G 30
Houghto-safe 271	Standard glycol FR #15
Houghto-safe 416	Standard glycol FR #20
Houghto-safe 520	Standard glycol FR #25
Houghto-safe 525	
Houghto-safe 616	Ucon hydrolube 150 CP
Houghto-safe 620	Ucon hydrolube 200 CP
Houghto-Safe 625	Ucon hydrolube 275 CP
Houghto-safe 640	Ucon hydrolube 300 CP
Hydra safe 620	Ucon hydrolube 550 CP
Hydra safe 625	Ucon hydrolube 900 CP
Hydraulic safety fluid 200	Ucon hydrolube 150 DB
Hydraulic safety fluid 300	Ucon hydrolube 275 DB
Hyspin AF-1	Ucon hydrolube 150 LT
Hyspin AF-2	Ucon hydrolube 200 LT
Hyspin AF-3	Ucon hydrolube 275 LT
	Ucon hydrolube 300 LT
	Ucon M-1
	Ucon hydrolube 200 NM
	Ucon hydrolube 300 NM



## Hydraulic fluids & lubricating oils (continued)

### Straight phosphate-ester (fr)

#### Maximum fluid temperature recommendation.

See caution on page 344 for maximum fluid temperatures and limiting ambient temperatures.

Hose classifications (see page 344)					
	1	2	3	4	6
H	U	+400°F	+200°F	U	200
LP	U	+400°F	+200°F	U	200

FR Fluids	Houghto-Safe 1010
Fyrquel 90	Houghto-Safe 1055
Fyrquel 150	Houghto-Safe 1115
Fyrquel 220	Houghto-Safe 1120
Fyrquel 300	Houghto-Safe 1130
Fyrquel 550	
Fyrquel 1000	Pyrogard 51
Fyrquel 150 R & O	Pyrogard 53
Fyrquel 220 R & O	Pyrogard 55
Fyrquel 550 R & O	
	Safetytex 215
Gulf FR Fluid P-37	Skydraul 500A
Gulf FR Fluid P-40	Skydraul 7000
Gulf FR Fluid P-43	
Gulf FR Fluid P-45	Univis P12
Gulf FR Fluid P-47	

### Silicone oils

#### Maximum fluid temperature recommendation.

See caution on page 344 for maximum fluid temperatures and limiting ambient temperatures.

Hose classifications (see page 344)				
	1	2	3	4
H	+200°F	+400°F	+200°F	+300°F
LP	+250°F	+400°F	+200°F	+300°F

Dow Corning 200 Fluid (100CS)	Dow Corning 3-3672
Dow Corning QF1-2023	
Dow Corning 4-3600	

### Ester blend turbine oils

#### Maximum fluid temperature recommendation.

See caution on page 344 for maximum fluid temperatures and limiting ambient temperatures.

Hose classifications (see page 344)				
	1	2	3	4
H	-	-	-	-
LP	+250°F	+450°F	+200°F	+300°F

Stauffer Jet I
Stauffer Jet II

### Polyol-ester

#### Maximum fluid temperature recommendation.

See caution on page 344 for maximum fluid temperatures and limiting ambient temperatures.

Hose classifications (see page 344)				
	1	2	3	4
H	+150°F	+400°F	-	+150°F
LP	+200°F	+400°F	-	+250°F

Quintolubric 822 Series

Hose style			
Lubricant	GH001	FC800	FC802
Mineral oil	Y	*	Y
PAG	Y	Y	Y
Ester oil	Y	Y	Y
Alkylbenzene	*	*	Y

Y = Compatible N = Non-compatible.

\* Contact product support for application review.

# Weatherhead

## Hose selection

### Hose routing and installation

In straight hose installations, allow enough slack in the hose line to provide for changes in length that will occur when pressure is applied. This change in length can be from +2% to -4%.

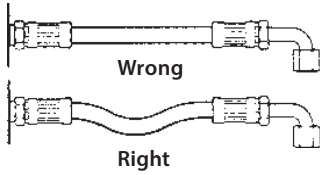

Keep the bend radius of the hose as large as possible to avoid collapsing of the hose and restriction of flow. Follow catalog specs on minimum bend radii.

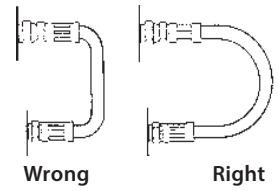

Do not twist hose during installation. This can be determined by the printed layline on the hose. Pressure applied to a twisted hose can cause hose failure or loosening of connections.

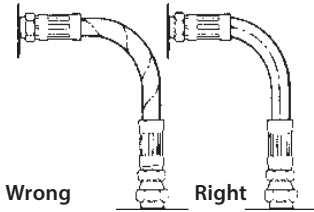

Minimum bend radius is measured on the inside bend of the hose. To determine minimum bend, divide the total distance between ends (B length) by 2. For example, B=6, minimum bend radius=3.

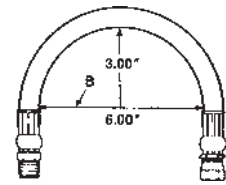

Keep hose away from hot parts. High ambient temperature will shorten hose life. If you can not route it away from the heat source, insulate it. (See Spring Guards page 236)

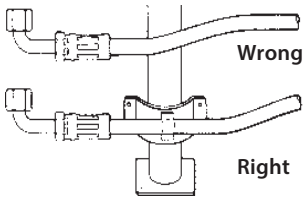

Install hose runs to avoid rubbing or abrasion. Use Weatherhead Hose Clamps to support long runs of hose or to keep hose away from moving parts. It is important that the clamps not allow the hose to move. This movement will cause abrasion and premature hose failure. (See Hose Clamps page 241 - 243)

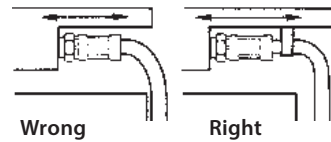

Use elbows and adapters in the installation to relieve strain on the assembly and to provide easier and neater installations that are accessible for inspection and maintenance.

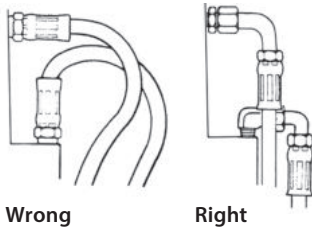

Make sure relative motion of the machine components produces bending rather than twisting of the hose. Hose should be routed so that the flex is in the same plane as the equipment movement.

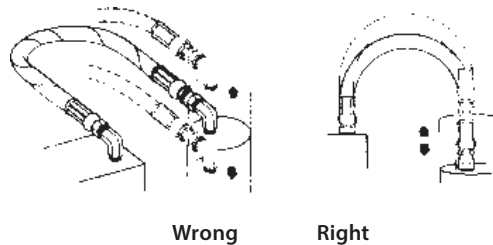

Refer to safety information regarding hose installation on page 330.

## Analyzing failures

Everyone in maintenance encounters hose failures. Normally, there is no problem. The hose is replaced and the equipment goes back in operation. Occasionally the failures come too frequently – the same equipment with the same problems keep popping up. At this point the task is to determine and correct the cause of these repeated failures.

Beginning with the most obvious, the most common cause of hose failures – Improper application – compare the hose specifications with the requirements of the application.

Pay particular attention to the following areas:

- The maximum operating pressure of the hose.

- The recommended temperature range of the hose.

- Whether the hose is rated for vacuum service.

- The fluid compatibility of the hose.

Check all of these areas against the requirements of the application. If they don't match up, you need to select another hose. It's a good idea at this point to call on your local hose distributor for assistance in selecting the proper hose. Danfoss' distributors, for example, are well equipped to perform this service for you.

Distributor personnel attend special training courses in hydraulics and hose application conducted by the company. Or, if your problem is particularly difficult, the distributor can call on the services of Danfoss' field engineering staff. The company will send in a hose and hydraulic specialist to study the problem and come up with a solution.

The second major cause of premature hose failure is improper assembly and installation procedures. This can involve anything from using the wrong fitting on a hose, to poor routing of the hose.

Danfoss provides excellent training material that you can use to combat this problem. A little time spent in training your maintenance people could pay big dividends in reduced downtime.

Contact Danfoss to register for a training session today.

External damage can range from abrasion and corrosion, to hose that is crushed by a lift truck.

These are problems that can normally be solved simply once the cause is identified. The hose can be re-routed or clamped, or a fire sleeve or abrasion guard can be used.

In the case of corrosion, the answer may be as simple as changing to a hose with a more corrosion resistant cover or re-routing the hose to avoid the corrosive element.

Too frequent or premature hose failure can be the symptom of a malfunction in your equipment. This is a factor that should be considered since prompt corrective action can sometimes avoid serious and costly equipment breakdown. Reprints of an article on "Troubleshooting hydraulic systems," which tells you how to spot problems in a hydraulic system are available from Danfoss.

Occasionally a failure problem will lie in the hose itself. The most likely cause of a faulty rubber hose is old age. Check the lay line on the hose to determine the date of manufacture. (2Q99 means second quarter 1999.) The hose may have exceeded its recommended shelf life. If you suspect that the problem lies in the manufacture of the hose (and don't jump to this conclusion until you have exhausted the other possibilities) contact your distributor. Given effective quality control methods, the odds of a faulty batch of hose being released for sale are extremely small. So make sure that you haven't overlooked some other problem area.

### Analyzing failures

A physical examination of the failed hose can often offer a clue to the cause of the failure. Following are 22 symptoms to look for along with the conditions that could cause them:

The hose tube is very hard and has cracked.

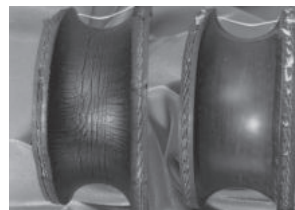

Heat has a tendency to leach the plasticizers out of the tube. This is a material that gives the hose its flexibility or plasticity.

Aerated oil causes oxidation to occur in the tube. This reaction of oxygen on a rubber product will cause it to harden. Any combination of oxygen and heat will greatly accelerate the hardening of the hose tube. Cavitation occurring inside the tube would have the same effect.

The hose is cracked both externally and internally but the elastomeric materials are soft and flexible at room temperature.



The probable reason is intense cold ambient conditions while the hose was flexed. Most standard hoses are rated to  $-40^{\circ}\text{F}$  ( $-40^{\circ}\text{C}$ ). Some hoses are rated at  $-55^{\circ}\text{F}$  ( $-49^{\circ}\text{C}$ ). Military specified hoses are generally rated to  $-65^{\circ}\text{F}$  ( $-54^{\circ}\text{C}$ ). PTFE hose is rated to  $-100^{\circ}\text{F}$  ( $-73^{\circ}\text{C}$ ). Some Everflex Polyon thermoplastic hoses are rated at  $-65^{\circ}\text{F}$  ( $-54^{\circ}\text{C}$ ).

The hose has burst and examination of the wire reinforcement after stripping back the cover reveals random broken wires the entire length of the hose.



This would indicate a high frequency pressure impulse condition. SAE impulse test requirements for a double wire braid reinforcement are 200,000 cycles at 133% of recommended working pressure. The SAE impulse test requirements for a four spiral wrapped reinforcement (100R12) are 500,000 cycles at 133% maximum operating and at  $+250^{\circ}\text{F}$  ( $121^{\circ}\text{C}$ ). If the extrapolated impulses in a system amount to over a million in a relatively short time a spiral reinforced hose would be the better choice.

Analyzing failures

**Analyzing failures**

The hose has burst, but there is no indication of multiple broken wires the entire length of the hose. The hose may have burst in more than one place.



This would indicate that the pressure has exceeded the minimum burst strength of the hose. Either a stronger hose is needed or the hydraulic circuit has a malfunction which is causing unusually high pressure conditions.

Hose has burst. An examination indicates the wire braid is rusted and the cover has been cut, abraded or deteriorated badly.



The primary function of the cover is to protect the reinforcement. Elements that may destroy or remove the hose covers are:

1. Abrasion
2. Cutting
3. Battery acid
4. Steam cleaners
5. Chemical cleaning solutions
6. Muriatic acid (for cement clean-up)
7. Salt water
8. Heat
9. Extreme cold

Once the cover protection is gone the wire reinforcement is susceptible to attack from moisture or other corrosive matter.

Hose has burst on the outside bend and appears to be elliptical in the bent section. In the case of a pump supply line, the pump is noisy and very hot. The exhaust line on the pump is hard and brittle.

Violation of the minimum bend radius is most likely the problem in both cases. Check the minimum bend radius and make sure that the application is within specifications. In the case of the pump supply line partial collapse of the hose is causing the pump to cavitate creating both noise and heat. This is a most serious situation and will result in catastrophic pump failure if not corrected.

Hose appears to be flattened out in one or two areas and appears to be kinked. It has burst in this area and also appears to be twisted.



Torquing of a hydraulic control hose will tear loose the reinforcement layers and allow the hose to burst through the enlarged gaps between the braided plaits of wire strands. Use swivel fittings or joints to be sure there is no twisting force on a hydraulic hose.

Hose type has broken loose from the reinforcement and piled up the end of the hose. In some cases it may protrude from the end of the hose fitting.

The probable cause is high vacuum or the wrong hose for vacuum service. No vacuum is recommended for double wire braid, 4 and 6 spiral wire hose unless some sort of internal coil support is used. Even though a hose is rated for vacuum service, if it is kinked, flattened out or bent too sharply this type of failure may occur.

Hose has burst about six to eight inches away from the end fitting. The wire braid is rusted. There are no cuts or abrasions of the outer cover.

Improper assembly of the hose end fitting allowing moisture to enter around the edge of the fitting socket. The moisture will wick through the reinforcement. The heat generated by the system will drive it out around the fitting area but six to eight inches away it will be entrapped between the inner line and outer cover causing corrosion of the wire reinforcement.

There are blisters in the cover of the hose. If one pricks the blisters, oil will be found in them.

A minute pin hole in the hose tube is allowing the high pressure oil to seep between it and the cover. Eventually it will form a blister wherever the cover adhesion is weakest. In the case of a screw together reusable fitting insufficient lubrication of the hose and fitting can cause this condition because the dry tube will adhere to the rotating nipple and tear enough to allow seepage. Faulty hose can also cause this condition.

Blistering of the hose cover where a gaseous fluid is being used.



The high pressure gas is effusing through the hose tube, gathering under the cover and eventually forming a blister wherever the adhesion is weakest. Specially constructed hoses are available for high pressure gaseous applications. Your supplier can advise you on the proper hose to use in these cases.

Fitting blew off of the end of the hose.

It may be that the wrong fitting has been put on the hose. Recheck manufacturer's specifications and part numbers. In the case of a crimped fitting the wrong machine setting may have been used resulting in over or under crimping. The socket of a screw together fitting for multiple wire braided hose may be worn beyond its tolerance. The swaging dies in a swaged hose assembly may be worn beyond the manufacturer's tolerances. The fitting may have been applied improperly to the hose. Check manufacturer's instructions. The hose may have been installed without leaving enough slack to compensate for the possible 4% shortening that may occur when the hose is pressurized. This will impose a great force on the fitting. The hose itself may be out of tolerance.

The tube of the hose is badly deteriorated with evidences of extreme swelling. In some cases the hose tube may be partially "washed out."

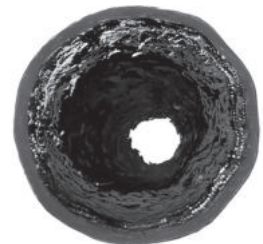

Indications are that the hose tube is not compatible with the agent being carried. Even though the agent is normally compatible, the addition of heat can be the catalyst that can cause inner liner deterioration. Consult your hose supplier for a compatibility list or present him with a sample of the fluid being conducted by the hose for analysis. Make sure that the operating temperatures both internal and external do not exceed recommendations.

Hose has burst. The hose cover is badly deteriorated and the surface of the rubber is crazed.

## Analyzing failures

This could be simply old age. The crazed appearance is the effect of weathering and ozone over a period of time. Try to determine the age of the hose. Some manufacturers print or emboss the cure date on the outside of the hose. As an example, Weatherhead hose would show "4Q01" which would mean that the hose was manufactured during the fourth quarter (October, November or December) of 2001.

Hose is leaking at the fitting because of a crack in the metal tube adjacent to the braze on a split flange head.

Because the crack is adjacent to the braze and not in the braze this is a stress failure brought on by a hose that is trying to shorten under pressure and has insufficient slack in it to do so. We have cured dozens of these problems by lengthening the hose assembly or changing the routing to relieve the forces on the fitting.

A spiral reinforced hose has burst and literally split open with the wire exploded out and badly entangled.



The hose is too short to accommodate the change in length occurring while it is pressured.

Hose is badly flattened out in the burst area. The tube is very hard down stream of the burst but appears normal up stream of the burst.



The hose has been kinked either by bending it too sharply or by squashing it in some way so that a major restriction was created. As the velocity of the fluid increases through the restriction the pressure decreases to the vaporization point of the fluid being conveyed. This is commonly called cavitation, and causes heat and rapid oxidation to take place which hardens the tube of the hose down stream of the restriction.

Hose has not burst but it is leaking profusely. A bisection of the hose reveals that the tube has been gouged through to the wire braid for a distance of approximately two inches.

This failure would indicate that erosion of the hose tube has taken place. A high velocity needle like fluid stream being emitted from an orifice and impinging at a single point on the hose tube will hydraulically remove a section of it. Be sure that the hose is not bent close to a port that is orificed. In some cases where high velocities are encountered particles in the fluid can cause considerable erosion in bent sections of the hose assembly.

The hose fitting has been pulled out of the hose. The hose has been considerably stretched out in length. This may not be a high pressure application.

Insufficient support of the hose. It is very necessary to support very long lengths of hose, especially if they are vertical. The weight of the hose along with the weight of the fluid inside the hose in these cases is being imposed on the hose fitting. This force can be transmitted to a wire rope or chain by clamping the hose to it much like the utilities support bundles of wire from pole to pole. Be sure to leave sufficient slack in the hose between clamps to make up for the possible 4% shortening that could take place when the hose is pressurized.

The hose has not burst but it is leaking profusely. An examination of the bisected hose reveals that the tube has burst inwardly.

This type of failure is commonly referred to as hose tube blow down. It is usually associated with very low viscosity fluids such as air, nitrogen, freon and other gases. What happens is that under high pressure conditions the gases will effuse into the pores of the hose tube charging them up like miniature accumulators. If the pressure is very suddenly reduced to zero the entrapped gases literally explode out of the tube often tearing holes in it. In some hose constructions a second hose tube made from a plastic such as nylon, is inserted into the hose.

A small leak will allow the gaseous fluid to seep between the two inner liners and when pressure is reduced to zero the innermost liner will collapse because the entrapped pressure around its inner diameter.

PTFE hose assembly has collapsed internally in one or more places.

One of the most common causes for this is improper handling of the PTFE assembly. PTFE is a thermoplastic material which is not rubber-like. When bent sharply it simply collapses. This type of collapse is localized in one area and is radical. When the PTFE tube is folded longitudinally in one or more places this could be the result of heat (which softens the hose) along with vacuum conditions inside of it. Because of the additional tension of the wire braid, reinforcement inherent with this type of hose, there is always a radial tension on the tube trying to push it in. Rapid cycling from a very hot agent in the hose to a very cold agent in the hose can produce the same type of failure. Weatherhead by Danfoss offers an internal support coil that will eliminate this problem.

A PTFE hose assembly has developed a pin hole leak or several pin hole leaks.

This situation occurs when a petroleum based fluid, with low viscosity, is flowing at high velocity. This condition can generate high voltage use to static electricity. The high voltage is seeking a ground connection and the only ground connection available is the braided stainless steel reinforcement. This causes an electric arc, which penetrates through the PTFE tube as it travels to the reinforcement. Specially constructed PTFE tubes are available that have enough carbon black in them so as to be conductive. They will "drain off" the static electricity and preclude this problem.



# Weatherhead

## Fluid connectors identification

### Fluid connectors identification

Measuring Tools: A seat angle gauge, thread pitch gauge and an I.D./O.D. caliper are necessary to make accurate measurements of commonly used connectors. Danfoss offers a unique new caliper than offers the capabilities of both a caliper and a seat angle gauge in one unit.



### Identification Tool Kit

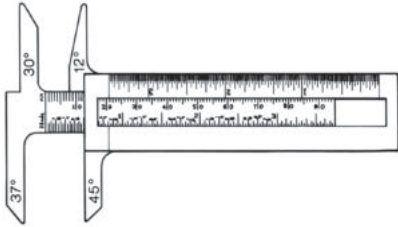

I.D./O.D. Angle gauge caliper

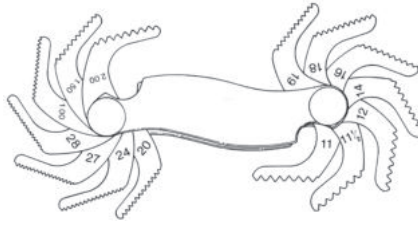

Thread pitch gauge

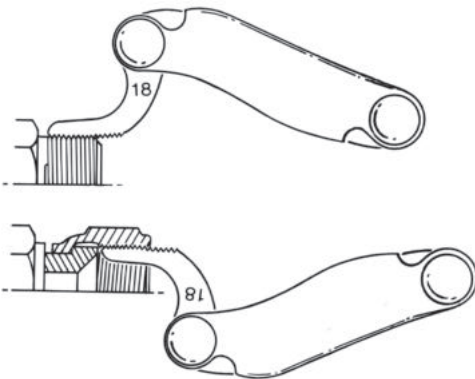

**Female** connections are usually measured by inserting the gauge into the connection and placing it on the sealing surface. If the centerlines of the connection and gauge are parallel, the correct angle has been determined.

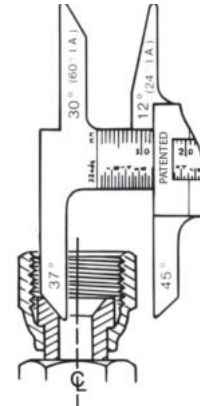

Use a thread pitch gauge to determine the number of threads per inch or the distance between threads in metric connections. Place the gauge on the threads until the fit is snug. Match the measurement to the charts.

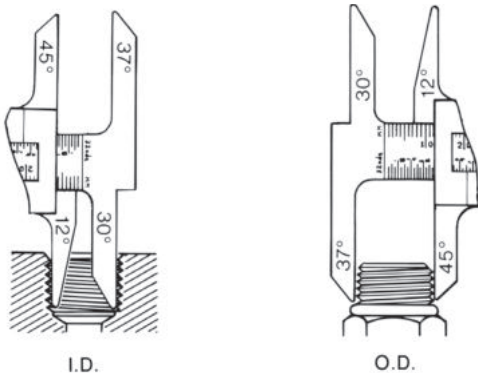

**Male flare type** connectors are usually measured by placing the gauge on the sealing surface. If the centerlines of the connection and gauge are parallel, the correct angle has been determined.

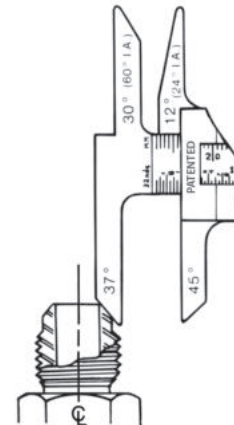

Measure the thread diameter with an I.D./O.D. caliper as shown. Match the measurements to the charts.

## Thread size chart

The following chart is intended as a quick reference guide for thread size by dash size.

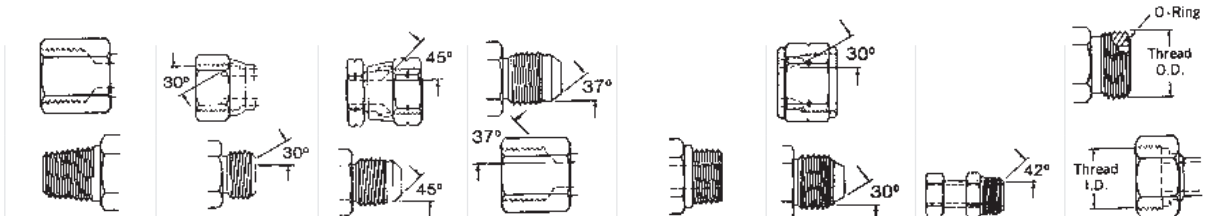

Dash size	N.P.T.F.	N.P.S.M. approx. dia.	SAE 45° auto. refrig.	SAE 37° (J.I.C.) hydraulic	SAE O-Ring boss	P.T.T. 30° automotive	SAE invert. flare	ORS
-02	1/8-27	1/8-27	5/16-24	5/16-24	5/16-24	-	5/16-24	-
-03	-	-	3/8-24	3/8-24	3/8-24	-	3/8-24	-
-04	1/4-18	1/4-18	7/16-20	7/16-20	7/16-20	-	7/16-24	9/16-18
-05	-	-	1/2-20	1/2-20	1/2-20	-	1/2-20	-
-06	3/8-18	3/8-18	5/8-18	9/16-18	9/16-18	-	5/8-18	11/16-16
-07	-	-	11/16-24	-	-	-	11/16-18	-
-08	1/2-14	1/2-14	3/4-16	3/4-16	3/4-16	-	3/4-18	13/16-16
-10	-	-	7/8-14	7/8-14	7/8-14	-	7/8-18	1-14
-12	3/4-14	3/4-14	1 1/16-14	1 1/16-12	1 1/16-12	-	1 1/16-16	1 3/16-12
-14	-	-	-	1 3/16-12	1 3/16-12	-	-	-
-16	1-11 1/2	1-11 1/2	-	1 5/16-12	1 5/16-12	1 5/16-14	-	1 7/16-12
-20	1 1/4-11 1/2	1 1/4-11 1/2	-	1 5/8-12	1 5/8-12	1 5/8-14	-	1 11/16-12
-24	1 1/2-11 1/2	1 1/2-11 1/2	-	1 7/8-12	1 7/8-12	1 7/8-14	-	2-12
-32	2-11 1/2	2-11 1/2	-	2 1/2-12	2 1/2-12	2 1/2-12	-	-
-40	2 1/2-8	2 1/2-8	-	3-12	3-12	-	-	-
-48	3-8	3-8	-	3 1/2-12	3 1/2-12	-	-	-

All dimensions are nominal. In jump size bodies, the minimum through hole dimensions will correspond to the smallest dash size.

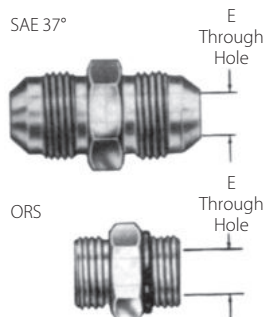

Dash size	E through hole			
	SAE 37°		ORS	
	mm	in	mm	in
-03	3,0	0.12	-	-
-04	4,3	0.17	4,3	0.17
-05	5,8	0.23	-	-
-06	7,6	0.30	6,6	0.26
-08	9,9	0.39	9,7	0.38
-10	12,2	0.48	12,2	0.48
-12	15,5	0.61	15,5	0.61
-16	21,3	0.84	20,6	0.81
-20	25,8	1.08	26,7	1.05
-24	33,3	1.31	33,3	1.31
-32	45,2	1.78	-	-

## Weatherhead

Proper tube installation

### Proper tube installation

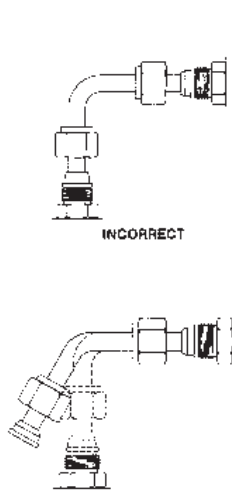

Figure 1

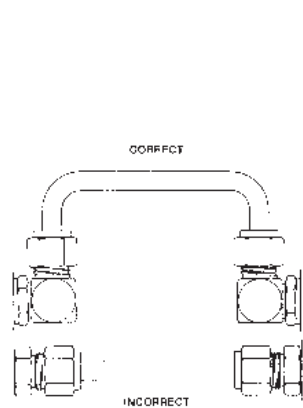

Figure 2

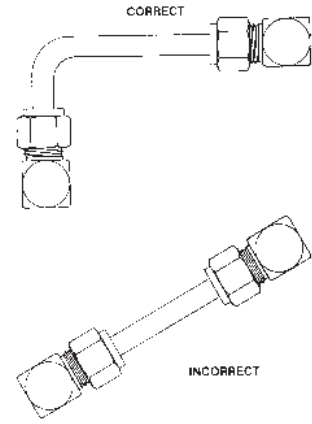

Figure 3

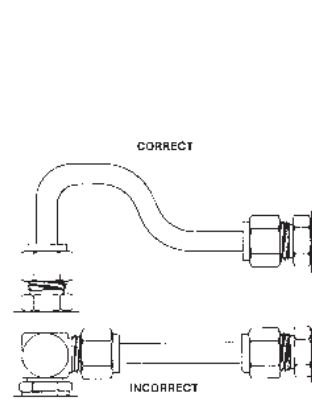

Figure 4

When compared to rigid pipe, hydraulic tubing offers the following advantages:

1. Size for size, tubing is lighter in weight, easier to handle and can be bent more easily than iron pipe.
2. Bent tubing reduces pressure drop and turbulence in the system because it eliminates sudden change in the direction of the fluid flow.
3. Hydraulic tubing reduces the number of connections required, thus reducing material and labor costs.
4. Fewer joints means lower costs and fewer points of potential leakage.
5. The use of tube fittings makes every joint a union which permits easier, faster maintenance and repair work.
6. The ORS-TF Tube Fitting eliminates the need for threading, brazing or welding.

To reduce the number of fittings in a tube assembly, bend the tubing whenever possible.

Steel tubing can be bent in many sizes by using a hand bender designed for steel tubing. For production quantities, or for larger sizes, a power bending tool is generally used.

Contact Danfoss for additional tube bending information.

Tubing manufacturers will advise the correct radii for various types and wall thicknesses of tubing. Kinks, flattened bends, wrinkles and tube breakage can be avoided by the use of proper tube bending equipment.

Avoid straight line connections whenever possible, especially in short runs.

Fluid conveying systems (see figures 2, 3 and 4) should be designed to follow the contour of the equipment. They are easier to install and present a neater appearance. Long runs should be supported by brackets or clamps. All heavy systems components should be bolted or clamped to eliminate tubing fatigue.

Inspect the tubing to see that it conforms to the required specifications before installation.

Tubes should align with the center line of the fittings, without distortion or tension. Tubing should not be sprung into position (see figure 1) to be assembled to the fitting. If this occurs the tubing has not been properly fabricated, and when installed and connected, places the tubing under stress.



## Hydraulic tubing–Maximum operating pressures

### SAEJ356, J524, J525, J526, J527

Tube O.D.	Dash size	Tubing wall thickness (in inches)											
		0.028		0.035		0.049		0.065		0.083		0.095	
-	-	bar	psi	bar	psi	bar	psi	bar	psi	bar	psi	bar	psi
0.19	-03	297,0	4250	375,0	5450	-	-	-	-	-	-	-	-
0.25	-04	213,0	3100	272,0	3950	396,0	5750	420,0	6000	-	-	-	-
0.31	-05	169,0	2450	213,0	3100	315,0	4500	420,0	6000	-	-	-	-
0.38	-06	140,0	2000	175,0	2550	251,0	3650	350,0	5000	420,0	6000	420,0	6000
0.50	-08	-	-	127,0	1850	186,0	2700	251,0	3650	335,0	4800	388,0	5550
0.62	-10	-	-	105,0	1500	145,0	2100	196,0	2850	258,0	3750	299,0	4350
0.75	-12	-	-	84,0	1200	122,0	1750	162,0	2350	210,0	3050	248,0	3550
1.00	-16	-	-	62,0	900	89,0	1300	122,0	1750	157,0	2250	182,0	2600
1.25	-20	-	-	-	-	70,0	1000	93,0	1350	122,0	1750	143,0	2050
1.50	-24	-	-	-	-	-	-	79,0	1150	100,0	1450	119,0	1700
2.00	-32	-	-	-	-	-	-	58,0	850	77,0	1100	87,0	1250

Tube O.D.	Dash size	Tubing wall thickness (in inches)											
		0.109		0.120		0.134		0.148		0.156		0.188	
-	-	bar	psi	bar	psi	bar	psi	bar	psi	bar	psi	bar	psi
0.19	-03	-	-	-	-	-	-	-	-	-	-	-	-
0.25	-04	-	-	-	-	-	-	-	-	-	-	-	-
0.31	-05	-	-	-	-	-	-	-	-	-	-	-	-
0.38	-06	-	-	-	-	-	-	-	-	-	-	-	-
0.50	-08	420,0	6000	420,0	6000	-	-	-	-	-	-	-	-
0.62	-10	353,0	5050	392,0	5600	-	-	-	-	-	-	-	-
0.75	-12	286,0	4150	322,0	4600	-	-	-	-	-	-	-	-
1.00	-16	210,0	3000	231,0	3350	262,0	3800	294,0	4200	-	-	-	-
1.25	-20	162,0	2350	182,0	2650	189,0	2700	203,0	2950	217,0	3100	259,0	3750
1.50	-24	134,0	1950	148,0	2150	171,0	2450	171,0	2450	182,0	2600	220,0	3150
2.00	-32	100,0	1450	112,0	1600	126,0	1800	140,0	2000	147,0	2100	178,0	2550

Maximum operating pressure ratings at specified wall thickness are based upon recommended tubing ratings per SAEJ1065 as well as limited laboratory test data. Operating pressures are based upon a 4:1 safety factor

relative to tube burst data. Danfoss recommends a maximum operating pressure of the joint which is the lesser of the tubing rating or the mating connector rating.

## Weatherhead

Recommendations: wall thickness and material

### Recommended wall thickness for tube fitting applications

Tube	Dash	Versil-Flare SAE 37° flare	Versil-Flare SAE 37° flareless	ORS-BR SAE O-Ring face seal	ORS-TF SAE O-ring face seal
0.19	-03	0.028 - 0.035	0.028 - 0.035	-	-
0.25	-04	0.028 - 0.065	0.028 - 0.065	0.028 - 0.065	0.028 - 0.065
0.31	-05	0.028 - 0.065	0.028 - 0.065	-	-
0.38	-06	0.028 - 0.065	0.028 - 0.095	0.035 - 0.083	0.028 - 0.065
0.50	-08	0.035 - 0.083	0.035 - 0.120	0.035 - 0.109	0.035 - 0.120
0.62	-10	0.035 - 0.095	0.035 - 0.120	0.035 - 0.120	0.035 - 0.095
0.75	-12	0.035 - 0.109	0.035 - 0.120	0.035 - 0.120	0.049 - 0.120
1.00	-16	0.035 - 0.120	0.035 - 0.134	0.049 - 0.148	0.049 - 0.134
1.25	-20	0.049 - 0.120	0.049 - 0.188	0.049 - 0.188	0.049 - 0.156
1.50	-24	0.065 - 0.120	0.065 - 0.188	0.065 - 0.188	0.065 - 0.188
2.00	-32	0.065 - 0.134	0.065 - 0.188	-	-

### Recommended hydraulic tubing material specifications

Hydraulic tubing SAE specifications			
Versil-Flare SAE 37° flare	Versil-Flare SAE 37° flareless	ORS-BR SAE O-ring face seal	ORS-TF SAE O-ring face seal
SAEJ524	SAEJ356	SAEJ356	SAEJ356
SAEJ525	SAEJ524	SAEJ524	SAEJ524
-	SAEJ525	SAEJ525	SAEJ525
-	SAEJ527	SAEJ526	SAEJ526

#### Hydraulic tubing material description

SAEJ356 electric resistance welded flash controlled low carbon steel, SAEJ524 seamless annealed low carbon steel, SAEJ525 electric resistance welded cold worked annealed,

SAEJ526 single wall welded low carbon steel (automotive), SAEJ527 brazed double wall low carbon steel (automotive). The maximum hardness of the above tubing should not exceed Rockwell B65.

## How to measure non-threaded connections

First measure the port hole diameter using the caliper. Next, measure the longest bolt hole spacing from center- to-center or measure the flange head diameter.

Measure the male diameter with the O.D. portion of the caliper. Measure the female half by inserting the I.D. portion of the caliper into the through hole.

Most fluid piping system sizes in the United States are measured by dash numbers. These are universally used abbreviations for the size of the component expressed as the numerator of the fraction

with the denominator always being 16. For example, a -04 port is 4/16 or 1/4-inch. Dash numbers are usually nominal (in name only) and are abbreviations that make ordering of components easier.

## American connections

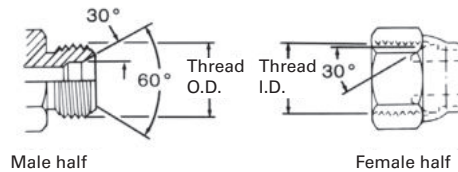
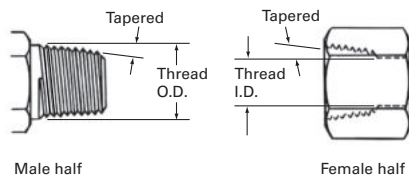

This connection is still widely used in fluid power systems, even though it is not recommended by the National Fluid Power Association (NFPA) for use in hydraulic applications. The thread

is tapered and the seal takes place by deformation of the threads.

This connection is sometimes used in fluid power systems. The female half has a straight thread and an inverted 30° seat. The male half of the connection has a straight thread and a 30° internal chamfer. The seal takes place by compression of the 30° seat on

the chamfer. The threads hold the connection mechanically.

A properly chamfered NPTF male will also seal with the NPSM female.

NPTF threads		Measure thread diameter and subtract 1/4-inch to find the nominal pipe size.				
Inch size	Dash size.	Nominal thread size	Male thread O.D. inch		Female thread I.D. inch	
			Frac.	Dec.	Frac.	Dec.
1/8	02	1/8-27	13/32	0.41	3/8	0.38
1/4	04	1/4-18	17/32	0.54	1/2	0.49
3/8	06	3/8-18	11/16	0.68	5/8	0.63
1/2	08	1/2-14	27/32	0.84	25/32	0.77
3/4	12	3/4-14	1 1/16	1.05	1	0.98
1	16	1-11 1/2	1 5/16	1.32	1 1/4	1.24
1 1/4	20	1 1/4-11 1/2	1 21/32	1.66	1 19/32	0.58
1 1/2	24	1 1/2-11 1/2	1 29/32	1.90	1 13/16	1.82
2	32	2-11 1/2	2 3/8	2.38	2 5/16	2.30

NPSM threads							
Inch size	Dash size.	Nominal thread size	Male thread O.D. inch		Female thread I.D. inch		
			Frac.	Dec.	Frac.	Dec.	
1/8	02	1/8-27	13/32	0.41	3/8	0.38	
1/4	04	1/4-18	17/32	0.54	1/2	0.49	
3/8	06	3/8-18	11/16	0.68	5/8	0.63	
1/2	08	1/2-14	27/32	0.84	25/32	0.77	
3/4	12	3/4-14	1 1/16	1.05	1	0.98	
1	16	1-11 1/2	1 5/16	1.32	1 1/4	1.24	
1 1/4	20	1 1/4-11 1/2	1 21/32	1.66	1 19/32	0.58	
1 1/2	24	1 1/2-11 1/2	1 29/32	1.90	1 13/16	1.82	
2	32	2-11 1/2	2 3/8	2.38	2 5/16	2.30	

## American connections

### SAE J1926 straight thread O-Ring boss (ORB)

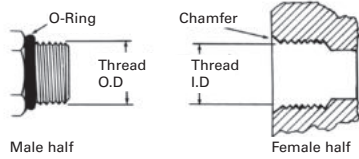

This port connection is recommended by the NFPA for optimum leakage control in medium and high pressure hydraulic systems. The male connector has a straight thread and an O-Ring. The female port has a straight thread, a machined

surface (minimum spotface) and a chamfer to accept the O-Ring. The seal takes place by compressing the O-Ring into the chamfer. The threads hold the connection mechanically.

Inch size	Dash size.	Nominal thread size	Male thread O.D. inch		Female thread I.D. inch	
			Fract.	Dec.	Fract.	Dec.
1/8	02	5/16-24	5/16	0.31	9/32	0.27
3/16	03	3/8-24	3/8	0.38	11/32	0.34
1/4	04	7/16-20	7/16	0.44	13/32	0.39
5/16	05	1/2-20	1/2	0.50	15/32	0.45
3/8	06	9/16-18	9/16	0.56	17/32	0.51
1/2	08	3/4-16	3/4	0.75	3/4	0.69
5/8	10	7/8-14	7/8	0.88	13/16	0.81
3/4	12	1 1/16-12	1 1/16	1.06	1	0.98
7/8	14	1 3/16-12	1 3/16	1.19	1 1/8	1.13
1	16	1 5/16-12	1 5/16	1.31	1 1/4	1.23
1-1/4	20	1 5/8-12	1 5/8	1.63	1 9/16	1.54
1-1/2	24	1 7/8-12	1 7/8	1.88	1 13/16	1.79
2	32	2 1/2-12	2 1/2	2.50	2 7/16	2.42

### SAE J514 37° hydraulic

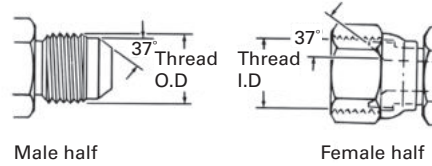

This connection is very common in fluid power systems. Both the male and female halves of the connections have 37° seats. The seal takes place by establishing a line contact between the male flare and the female cone seat. The threads

hold the connection mechanically.

**Caution:** In the -02, -03, -04, -05, -08 and -10 sizes, the threads of the SAE 45° flare and the SAE 37° flare are the same. However, the sealing surface angles are not the same.

Inch size	Dash size.	Nominal thread size	Male thread O.D. inch		Female thread I.D. inch	
			Fract.	Dec.	Fract.	Dec.
1/8	02	5/16-24	5/16	0.31	9/32	0.27
3/16	03	3/8-24	3/8	0.38	11/32	0.34
1/4	04	7/16-20	7/16	0.44	13/32	0.39
5/16	05	1/2-20	1/2	0.50	15/32	0.45
3/8	06	9/16-18	9/16	0.56	17/32	0.51
1/2	08	3/4-16	3/4	0.75	3/4	0.69
5/8	10	7/8-14	7/8	0.88	13/16	0.81
3/4	12	1 1/16-12	1 1/16	1.06	1	0.98
7/8	14	1 3/16-12	1 3/16	1.19	1 1/8	1.13
1	16	1 5/16-12	1 5/16	1.31	1 1/4	1.23
1-1/4	20	1 5/8-12	1 5/8	1.63	1 9/16	1.54
1-1/2	24	1 7/8-12	1 7/8	1.88	1 13/16	1.79
2	32	2 1/2-12	2 1/2	2.50	2 7/16	2.42

### ORS SAE J1453 O-Ring face seal

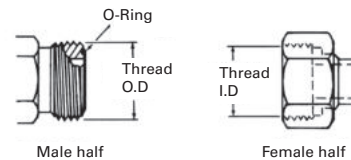

This connection offers the very best leakage control available today. The male connector has a straight thread and an O-Ring in the face. The female has a straight thread and a machined flat face.

The seal takes place by compressing the O-Ring onto the flat face of the female, similar to the split flange type fitting. The threads hold the connection mechanically.

Inch size	Dash size.	Nominal thread size	Male thread O.D. inch		Female thread I.D. inch	
			Fraction	Decimal	Fraction	Decimal
1/4	04	9/16-18	9/16	0.56	17/32	0.51
3/8	06	11/16-16	11/16	0.69	5/8	0.63
1/2	08	13/16-16	13/16	0.82	3/4	0.75
5/8	10	1-14	1	1.00	15/16	0.93
3/4	12	1 3/16-12	1 3/16	1.19	1 1/8	1.11
1	16	1 7/16-12	1 7/16	1.44	1 3/8	1.36
1-1/4	20	1 11/16-12	1 11/16	1.69	1 5/8	1.61
1-1/2	24	2-12	2	2.00	1 15/16	1.92

## American connections

### SAE J512 inverted

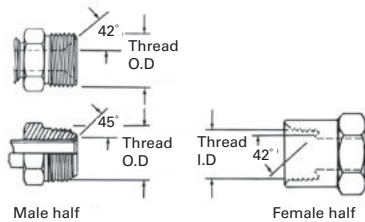

This connection is frequently used in automotive systems. The male connector can either be a 45° flare in the tube fitting form or a 42° seat in the machined adapter form.

with a 42° inverted flare. The seal takes place on the flared surfaces. The threads hold the connection mechanically.

The female has a straight thread

Inch size	Dash size	Nominal thread size	Male thread O.D. inch		Female thread I.D. inch	
			Fract.	Dec.	Fract.	Dec.
1/8	02	5/16-24	5/16	0.32	9/32	0.28
3/16	03	3/8-24	3/8	0.38	11/32	0.34
1/4	04	7/16-24	7/16	0.44	13/32	0.40
5/16	05	1/2-20	1/2	0.50	15/32	0.45
3/8	06	5/8-18	5/8	0.63	9/16	0.57
7/16	07	11/16-18	11/16	0.69	5/8	0.63
1/2	08	3/4-18	3/4	0.75	23/32	0.70
5/8	10	7/8-18	7/8	0.88	13/16	0.82
3/4	12	1 1/16-16	1 1/16	1.06	1	1.00

### SAE J512 45°

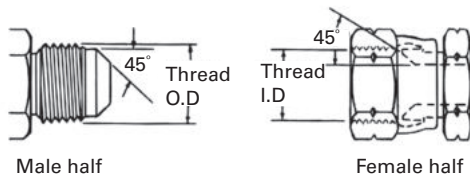

This connection is commonly used in refrigeration, automotive and truck piping systems. The connector is frequently made of brass. Both the male and female connectors have 45° seats. The seal takes place between the male flare the female

cone seat. The threads hold the connection mechanically.

**Caution:** In the -02, -03, -04, -05, -08 and -10 sizes, the threads of the SAE 45° flare and the SAE 37° flare are the same. However, the sealing surface angles are not the same.

Inch size	Dash size	Nominal thread size	Male thread O.D. inch		Female thread I.D. inch	
			Fract.	Dec.	Fract.	Dec.
1/8	02	5/16-24	5/16	0.31	9/32	0.27
3/16	03	3/8-24	3/8	0.38	11/32	0.34
1/4	04	7/16-20	7/16	0.44	13/32	0.39
5/16	05	1/2-20	1/2	0.50	15/32	0.45
3/8	06	5/8-18	5/8	0.63	9/16	0.57
1/2	08	3/4-16	3/4	0.75	11/16	0.69
5/8	10	7/8-14	7/8	0.88	13/16	0.81
3/4	12	1 1/16-14	1 1/16	1.06	1	0.99
7/8	14	1 1/4-12	1 1/4	1.25	1 5/32	1.16
1	16	1 3/8-12	1 3/8	1.38	1 9/32	1.29

### Staplok (SAE J1467)

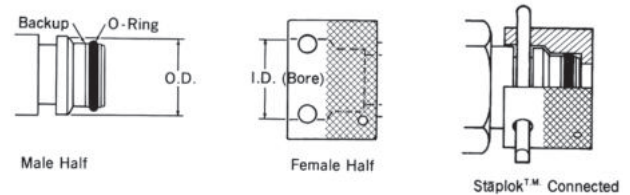

This is a radial O-Ring seal connection developed in Germany and commonly used for hydraulic application in underground mines. The male contains an exterior O-Ring and backup ring, plus a groove to accept the "staple". The female has a smooth bore

with two holes for the stable. A "U" shaped retaining clip or staple is inserted through the two holes, passing through the groove in the male to lock the connection together. The seal takes place by contact between the O-Ring in the male and the smooth bore of the female.

Inch size	Dash size	Nominal thread size	Male thread O.D. inch		Female thread I.D. inch	
			Fraction	Decimal	Fraction	Decimal
1/4	04	-	9/32	0.586	1 9/32	0.597
3/8	06	-	25/32	0.783	51/64	0.794
1/2	08	-	15/16	0.940	61/64	0.951
3/4	12	-	1 9/64	1.137	1 9/64	1.148
1	16	-	1 17/32	1.529	1 35/64	1.540
1-1/4	20	-	1 13/16	1.806	1 13/16	1.817
1-1/2	24	-	2 5/32	2.163	2 11/64	2.174
2	32	-	2 33/64	2.517	2 17/32	2.528

# Weatherhead

American connections

## American connections and ISO connections

Four Bolt Flange—First measure the port hole diameter using the caliper.

Next, measure the longest bolt hole spacing from center-to-center (Dimension "A") or measure the flanged head diameter.

### SAE J518 4-Bolt Flange\*

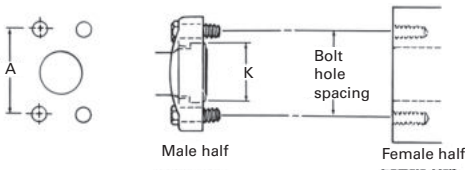

This connection is commonly used in fluid power systems. There are two pressure ratings. Code 61 is referred to as the "standard" series and Code 62 is the "6000 psi" series. The design concept for both series is the same, but the bolt hole spacing and flanged head diameters are larger for the higher pressure, Code 62 connection. The female (port) is an unthreaded hole with four bolt holes in a rectangular pattern around the port. The male consists of a flanged head,

grooved for an O-Ring, and either a captive flange or split flange halves with bolt holes to match the port. The seal takes place on the O-Ring, which is compressed between the flanged head and the flat surface surrounding the port. The threaded bolts hold the connection together.

NOTE: \* SAE J518, JIS B 8363, ISO/DIS 6162 and DIN 20066 are interchangeable, except for bolt sizes.

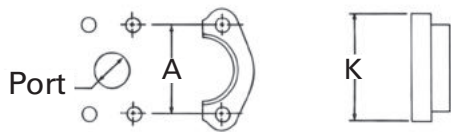

Inch Size (dash size)	Port hole I.D. inch fract. deci.)	Bolt dimension inch		Bolt hole spacing "A" inch (dec)		Flanged head dia. "K" inch (dec)	
		Cd. 61	Cd. 62	Cd. 61	Cd. 62	Cd. 61	Cd. 62
1/2 (08)	1/2 (0.50)	5/16-18x1 1/4	5/16-18x1 1/4	1 1/2 (1.50)	1 19/32 (1.59)	1 3/16 (1.19)	1 1/4 (1.25)
3/4 (12)	3/4 (0.75)	3/8-16x1 1/4	3/8-16x1 1/2	1 7/8 (1.88)	2.00 (2.00)	1 1/2 (1.50)	1 5/8 (1.63)
1 (16)	1.00 (1.00)	3/8-16x1 1/4	7/16-14x1 3/4	2 1/16 (2.06)	2 1/4 (2.25)	1 3/4 (1.75)	1 7/8 (1.88)
1 1/4 (20)	1 1/4 (1.25)	7/16-14x1 1/2	1/2-13x1 3/4	2 5/16 (2.31)	2 5/8 (2.63)	2.00 (2.00)	2 1/8 (2.13)
1 1/2 (24)	1 1/2 (1.50)	1/2-13x1 1/2	5/8-11x2 1/4	2 3/4 (2.75)	3 1/8 (3.12)	2 3/8 (2.38)	2 1/2 (2.50)
2 (32)	2.00 (2.00)	1/2-13x1 1/2	3/4-10x2 3/4	3 1/16 (3.06)	3 13/16 (3.81)	2 13/16 (2.81)	3 1/8 (3.12)

### ISO/DIS 6162 4-bolt flange\*

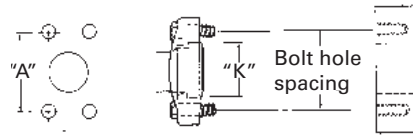

**Male half**  
This connection is commonly used in fluid power systems. There are two pressure ratings. PN 35/350 bar (Code 61) is the "standard" series and PN 415 bar (Code 62) is the high pressure series. The design concept for both series is the same, but the bolt hole spacing and flanged head diameters are larger for the higher pressure, PN 415 bar connection. Both metric and inches bolts are used. The port will have an "M" stamped on it if metric bolts are required.

**Female half**  
The female (port) is an unthreaded hole with four bolt holes in a rectangular pattern around the port. The male consists of a flanged head, grooved for an O-Ring, and either a captive flange or split flange halves with bolt holes to match the port. The seal takes place on the O-Ring, which is compressed between the flanged head and the flat surface surrounding the port. The threaded bolts hold the connection together.

\* ISO/DIS 6162, DIN 20066, JIS B 8363 and SAE J518 are interchangeable, except for bolt sizes.

Size	Port hole	Bolt dimensions spacing		Bolt hole "A"	
		ISO 6162-1 Bar (Cd.61)	ISO 6162-2 Bar (Cd.62)	ISO 6162-1 Bar (Cd.61)	ISO 6162-2 Bar (Cd.62)
mm in (dash)	mm (in)	mm (in)	mm (in)	mm (in)	mm (in)
13 (1/2) (08)	12,7 (.50)	M8 x 1.25x 30 (5/16-18 x 1-1/4)	M8 x 1.25 x 30 (5/16-18 x 1-1/4)	38.1 (1.50)	40.5 (1.57)
19 (3/4) (12)	19,1 (.75)	M10 x 1.5 x 35 (3/8-16 x 1-1/4)	M10 x 1.5 x 40 (3/8-16 x 1-1/2)	47.6 (1.88)	50.8 (2.00)
25 (1) (16)	25,4 (1.00)	M10 x 1.5 x 35 (3/8-16 x 1-1/4)	M12 x 1.75 x 45 (7/16-14 x 1-3/4)	52.4 (2.06)	57.2 (2.25)
32 (1-1/4) (20)	31,8 (1.25)	M10 x 1.5 x 40 (7/16-14 x 1-1/2)	M14 x 2 x 50 (1/2-13 x 1-3/4)	58.7 (2.31)	66.7 (2.63)
38 (1-1/2) (24)	38,1 (1.50)	M12 x 1.75 x 40 (1/2-13 x 1-1/2)	M16 x 2 x 55 (5/8-11 x 2-1/4)	69.9 (2.75)	79.4 (3.13)
51 (2) (32)	50,8 (2.00)	M12 x 1.75 x 40 (1/2-13 x 1-1/2)	M20 x 2.5 x 70 (3/4-10 x 2-3/4)	77.8 (3.06)	96.8 (3.81)

Inch size	Flanged head dia. "K"			
	ISO 6162-1 Bar (Cd.61)		ISO 6162-2 Bar (Cd.62)	
	mm	in	mm	in
1/2	30.18	1.19	31.75	1.25
3/4	38.10	1.50	41.28	1.63
1	44.45	1.75	47.63	1.88
1-1/4	50.80	2.00	53.98	2.13
1-1/2	60.33	2.38	63.50	2.50
2	71.42	2.81	79.38	3.13

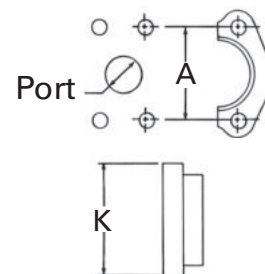

## German connections

### DIN 7631 series

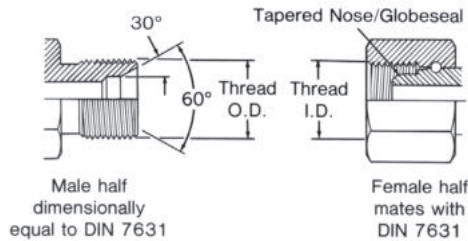

This connection is frequently used in hydraulic systems. The male has a straight metric thread and a 60° (included angle) recessed cone. The female has a straight thread and a tapered Nose/Globeseal seat. The seal takes place by contact between the cone

of the male and the nose of the tapered Nose/Globeseal flareless swivel.

The threads hold the connection mechanically.

Use with pipe/tube O.D.		Metric thread size	Male thread O.D.		Female thread I.D.	
mm	in		mm	in	mm	in
6	0.24	M12 x 1.5	12	0.47	10,5	0.41
8	0.32	M14 x 1.5	14	0.55	12,5	0.49
10	0.39	M16 x 1.5	16	0.63	14,5	0.57
12	0.47	M18 x 1.5	18	0.71	16,5	0.65
15	0.59	M22 x 1.5	22	0.87	20,5	0.81
18	0.71	M26 x 1.5	26	1.02	24,5	0.96
22	0.87	M30 x 1.5	30	1.18	28,5	1.12
28	1.10	M38 x 1.5	38	1.50	36,5	1.44
35	1.38	M45 x 1.5	45	1.77	43,5	1.71
42	1.65	M52 x 1.5	52	2.04	50,5	1.99

### DIN 3902 series

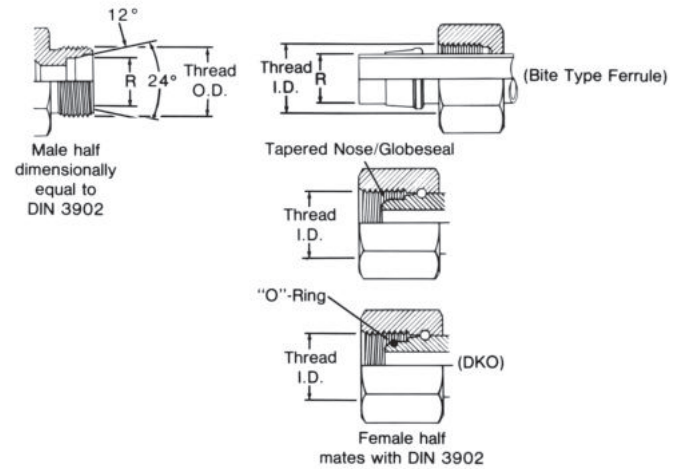

This connection style consists of a common male and three different female halves. The male has a straight metric thread, a 24° included angle and a recessed counterbore that matches the tube O.D. used with it. The female may be a tube, nut and

ferrule, a tapered nose/Globeseal flareless swivel or a tapered Nose/Globeseal flareless swivel with an O-Ring in the Nose (DKO type).

Tube O.D. "R" Dim. I.Rh.*		Tube O.D. "R" Dim. s.Rh.†		Metric thread Size	Male thread O.D.		Female thread I.D.	
mm	in.	mm	in.		mm	in	mm	in
6	0.24	-	-	M12 x 1.5	12	0.47	10.5	0.41
8	0.32	6	0.24	M14 x 1.5	14	0.55	12.5	0.49
10	0.39	8	0.32	M16 x 1.5	16	0.63	14.5	0.57
12	0.47	10	0.39	M18 x 1.5	18	0.71	16.5	0.65
-	-	12	0.47	M20 x 1.5	20	0.78	18.5	0.73
15	0.59	14	0.55	M22 x 1.5	22	0.87	20.5	0.81
-	-	16	0.63	M24 x 1.5	24	0.94	22.5	0.89
18	0.71	-	-	M26 x 1.5	26	1.02	24.5	0.96
22	0.87	20	0.78	M30 x 2.0	30	1.18	28	1.11
28	1.10	25	0.98	M36 x 2.0	36	1.41	34	1.34
-	-	30	1.18	M42 x 2.0	42	1.65	40	1.57
35	1.38	-	-	M45 x 2.0	45	1.77	43	1.70
42	1.65	38	1.50	M52 x 2.0	52	2.04	50	1.97

\*I.Rh. is a light duty system.  
 †s.Rh. is a heavy duty system.

# Weatherhead

German connections

## German connections

### DIN 20066 4-bolt flange\*

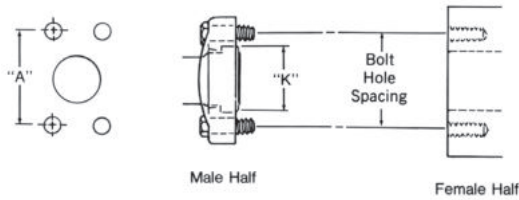

This connection is commonly used in fluid power systems. There are two pressure ratings. Form R (Code 61) is referred to as the "standard duty" series and Form S (Code 62) is the "heavy duty" series. The design concept for both series is the same, but the bolt hole spacing and flanged head diameters are larger for the higher pressure, Form S connection. Both metric and inch bolts are used. The female (port) is an unthreaded hole with four bolt holes in a rectangular pattern around the port. The male consists of a flanged head,

grooved for an O-Ring, and either a captive flange or split flange halves with bolt holes to match the port. The seal takes place on the O-Ring, which is compressed between the flanged head and the flat surface surrounding the port. The threaded bolts hold the connection together.

**NOTE:** \*DIN 20066, IS/DIS 6166, JIS B 8363 and SAE J518 are interchangeable, except for bolt sizes.

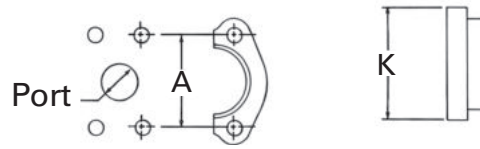

Inch size	Flanged head dia. "K"			
	Form R (Cd. 61)		Form S (Cd. 62)	
	mm	in	mm	in
1/2	30.18	1.19	31.75	1.25
3/4	38.10	1.50	41.28	1.63
1	44.45	1.75	47.63	1.88
1 1/4	50.80	2.00	53.98	2.13
1 1/2	60.33	2.38	63.50	2.50
2	71.42	2.81	79.38	3.13

Size mm (inch) (dash)	Port hole	Bolt dimensions		Bolt hole spacing	
		Form R (Cd. 61)	Form S (Cd. 62)	Form R (Cd. 61)	Form S (Cd. 62)
	mm (in)	-	-	mm (in)	mm (in)
12 (1/2) (08)	12,7 (0.50)	M8 x 1.25 x 30 5/16-18 x 1 1/4	M8 x 1.25 x 30 5/16-18 x 1 1/4	38.10 (1.50)	40.49 (1.57)
20 (3/4) (12)	19,1 (0.75)	M10 x 1.5 x 30 3/8-16 x 1 1/4	M10 x 1.5 x 40 3/8-16 x 1 1/2	47.63 (1.88)	50.80 (2.00)
25 (1) (16)	25,4 (1.00)	M10 x 1.5 x 35 3/8-16 x 1 1/4	M12 x 1.75 x 45 7/16-14 x 1 3/4	52.37 (2.06)	57.15 (2.25)
32 (1-1/4) (20)	31,7 (1.25)	M10 x 1.75 x 40 7/16-14 x 1 1/2	M14 x 2 x 45 1/2-13 x 1 3/4	58.72 (2.31)	66.68 (2.63)
40 (1-1/2) (24)	38,0 (1.50)	M12 x 1.75 x 40 1/2-13 x 1 1/2	M16 x 2 x 55 5/8-11 x 2 1/4	69.85 (2.75)	79.38 (3.13)
50 (2) (32)	50,8 (2.00)	M12 x 1.75 x 40 1/2-13 x 1 1/2	M20 x 2.5 x 70 3/4-10 x 2 3/4	77.77 (3.06)	96.82 (3.81)



## German connections

### DIN 3852 Male connectors and female ports

DIN 3852 metric threads				
Metric thread	Male thread O.D. "A"		Female thread I.D. "B"	
	mm	(in)	mm	(in)
M12 x 1.5	12	0.47	10,5	0.41
M14 x 1.5	14	0.55	12,5	0.49
M16 x 1.5	16	0.63	14,5	0.57
M18 x 1.5	18	0.71	16,5	0.65
M20 x 1.5	20	0.78	18,5	0.73
M22 x 1.5	22	0.87	20,5	0.81
M24 x 1.5	24	0.94	22,5	0.89
M26 x 1.5	26	1.02	24,5	0.96
M27 x 2	27	1.06	25	0.98
M30 x 1.5	30	1.18	28,5	1.12
M30 x 2	30	1.18	28	1.10
M33 x 2	33	1.30	31	1.22
M36 x 1.5	36	1.41	34,5	1.36
M36 x 2	36	1.41	34	1.33
M38 x 1.5	38	1.49	36,5	1.43
M38 x 2	38	1.49	36	1.41
M42 x 1.5	42	1.65	40,5	1.60
M42 x 2	42	1.65	40	1.57
M45 x 1.5	45	1.77	43,5	1.71
M45 x 2	45	1.77	43	1.69
M48 x 1.5	48	1.89	46,5	1.83
M48 x 2	48	1.89	46	1.81
M52 x 1.5	52	2.04	50,5	1.89
M52 x 2	52	2.04	50	1.97

For DIN 3852 Whitworth pipe thread dimensions, see BSPT/BSPP dimensions. They are the same.

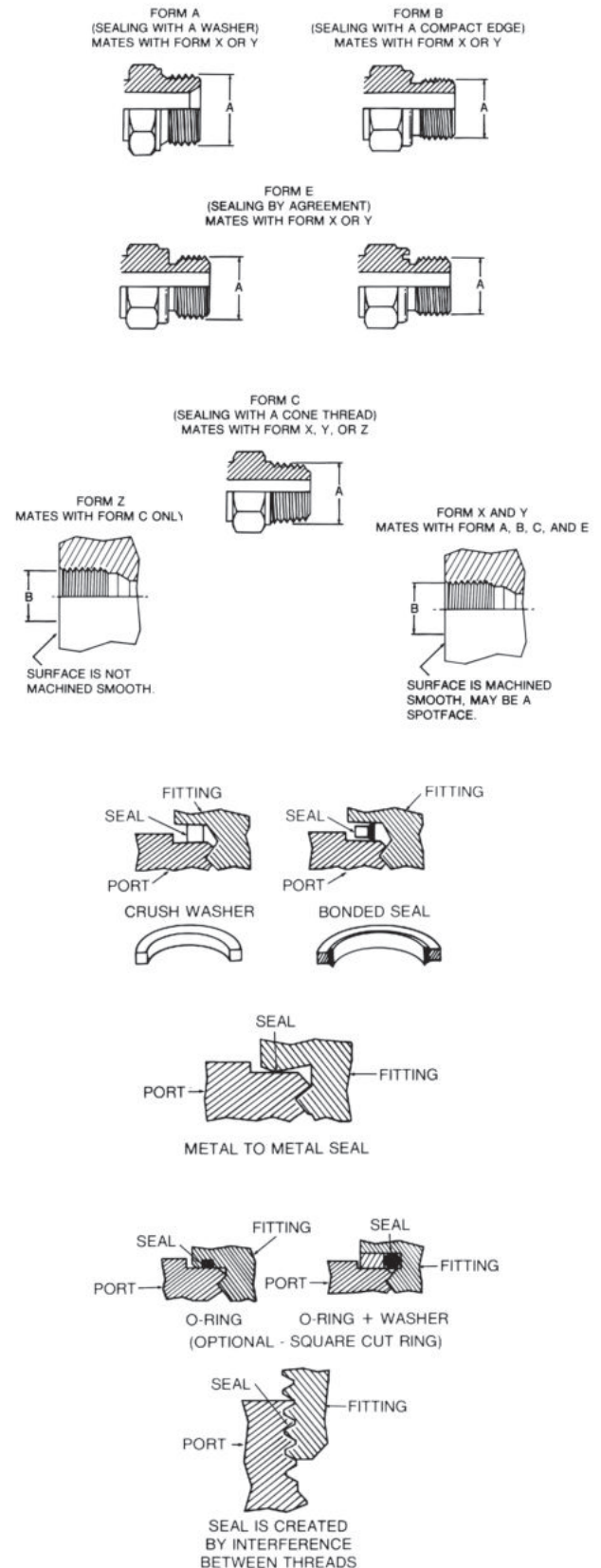

# Weatherhead

French and British connections

## French & British connections

### Millimetric and GAZ series

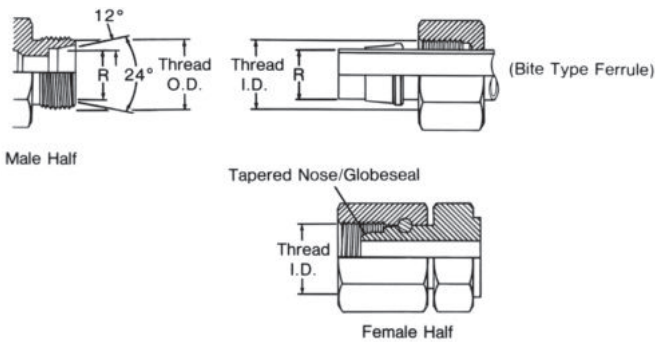

This connection consists of a common male and two different females. The millimetric series is used with whole number

metric O.D. tubing and the GAZ Series is used with fractional number metric O.D. pipe size tubing.

### Millimetric and GAZ threads

Tubing O.D. "R" dim.		"Gaz" pipe O.D. "R" dim.		Metric thread	Male Thread O.D. "A"		Female Thread I.D. "B"	
mm	in	mm	in		mm	(in)	mm	(in)
6	0.24	-	-	M12 x 1.5	12	0.47	11	0.43
8	0.32	-	-	M14 x 1.5	14	0.55	12.5	0.49
10	0.39	-	-	M16 x 1.5	16	0.63	14.5	0.57
12	0.47	-	-	M18 x 1.5	18	0.71	16.5	0.65
14	0.55	13.25	0.52	M20 x 1.5	20	0.78	18.5	0.73
15	0.59	-	-	M22 x 1.5	22	0.87	20.5	0.81
16	0.63	16.75	0.66	M24 x 1.5	24	0.94	22.5	0.89
18	0.71	-	-	M27 x 1.5	27	1.06	25.5	1.00
22	0.87	21.25	0.83	M30 x 1.5	30	1.18	28.5	1.12
25	0.98	-	-	M33 x 1.5	33	1.30	31.5	1.24
28	1.10	26.75	1.05	M36 x 1.5	36	1.41	34.5	1.36
30	1.18	-	-	M39 x 1.5	39	1.54	37.5	1.48
32	1.25	-	-	M42 x 1.5	42	1.65	40.5	1.60
35	1.38	33.50	1.32	M45 x 1.5	45	1.77	43.5	1.71
38	1.50	-	-	M48 x 1.5	48	1.89	46.5	1.83
40	1.57	42.25	1.66	M52 x 1.5	52	2.04	50.5	1.99
45	1.77	-	-	M54 x 2.0	54	2.12	52	2.05
-	-	48.25	1.90	M58 x 2.0	58	2.28	55	2.16

### British standard pipe(BSP)

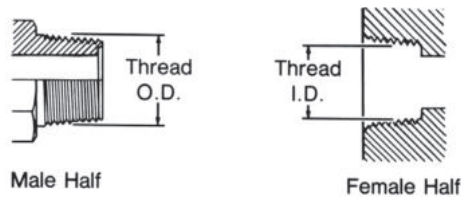

This BSPT (tapered) connection is similar to the NPT, except that the thread pitches are different in most sizes, and the thread form and O.D.s are close but not the

same. Sealing is accomplished by thread distortion. A thread sealant is recommended.

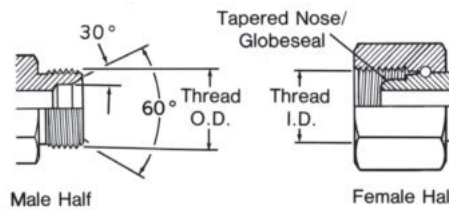

The BSP (parallel) male is similar to the NPSM male except the thread pitches are different in most sizes.

The female swivel BSPP has a tapered nose/Globeseal flareless swivel which seals on the cone seat of the male.

### BSPT/BSPP threads

Inch size	Dash size	Nominal thread size	Male thread O.D. inch		Female thread I.D. inch	
			fraction	decimal	fraction	decimal
1/8	02	1/8-28	3/8	0.38	11/32	0.35
1/4	04	1/4-19	33/64	0.52	15/32	0.47
3/8	06	3/8-19	21/32	0.65	19/32	0.60
1/2	08	1/2-14	13/16	0.82	3/4	0.75
5/8	10	5/8-14	7/8	0.88	13/16	0.80
3/4	12	3/4-14	1 1/32	1.04	31/32	0.97
1	16	1-11	1 5/16	1.30	1 7/32	1.22
1 1/4	20	1 1/4-11	1 21/32	1.65	1 9/16	1.56
1 1/2	24	1 1/2-11	1 7/8	1.88	1 25/32	1.79
2	32	2-11	2 11/32	2.35	2 1/4	2.26

\*Frequently, the thread size is expressed as a fractional dimension preceded by the letter "G" or the letter "R". The "G" represents a parallel thread and the "R" indicates a tapered thread. For example, BSPP 3/8-19 may be expressed as G 3/8, and BSPT 3/8-19 may be expressed as R3/8.

## Japanese connections

### JIS 30° male inverted seat, parallel pipe threads

(Threads per JIS B 0202)

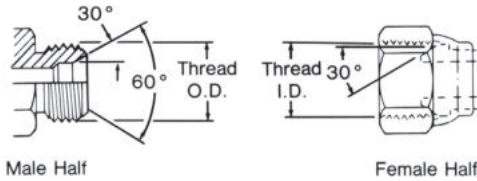

The JIS parallel is similar to the BSPP connection. The JIS parallel thread and the BSPP connection are interchangeable.

Inch size	Dash size	Nominal thread size (similar to bspp)	Male thread O.D.		Female thread O.D.	
			fract.	dec.	fract.	dec.
mm	mm					
1/4	6 (04)	1/4-19	33/64	13.2	15/32	11.9
3/8	9 (06)	3/8-19	21/32	16.7	19/32	15.3
1/2	12 (08)	1/2-14	13/16	21.0	3/4	19.2
3/4	19 (12)	3/4-14	1 1/32	26.4	31/32	24.6
1	25 (16)	1-11	1 5/16	33.3	1 7/32	30.9
1 1/4	32 (20)	1 1/4-11	1 21/32	41.9	1 9/16	39.6
1 1/2	38 (24)	1 1/2-11	1 7/8	47.8	1 25/32	45.5
2	50 (32)	2-11	2 11/32	59.7	2 1/4	57.4

### JIS 30° male inverted seat, parallel pipe threads

(Threads per JIS B 0207)

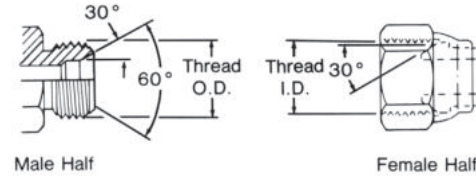

The JIS parallel (metric) is the same as the JIS parallel (PF),

except for the thread difference.

Inch size	Dash size equivalent	Thread size	Male thread O.D.		Female thread O.D.	
			fract.	dec.	fract.	dec.
mm	mm					
6	04	M14 x 1.5	14	0.55	12.5	0.49
9	06	M18 x 1.5	18	0.71	16.5	0.65
12	08	M22 x 1.5	22	0.87	20.5	0.81
19	12	M30 x 1.5	30	1.18	28.5	1.12
25	16	M33 x 1.5	33	1.30	31.5	1.24
32	20	M42 x 1.5	42	1.65	40.5	1.60

### JIS Tapered pipe (PT)

(Threads per JIS B 0203)

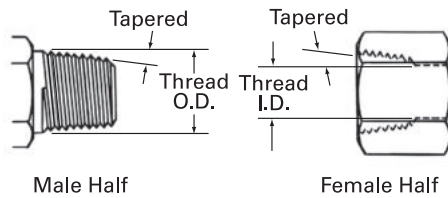

The JIS tapered thread is similar to the BSPT connection in design, appearance and dimensions. The JIS tapered thread and the BSPT connection are interchangeable.

Inch size	Dash size	Nominal thread size (similar to bspp)	Male thread O.D. inch		Female thread I.D. inch	
			fract.	dec.	fract.	dec.
mm	mm	-				
1/4	6 (04)	1/4-19	33/64	13.2	15/32	11.9
3/8	9 (06)	3/8-19	21/32	16.7	19/32	15.3
1/2	12 (08)	1/2-14	13/16	21.0	3/4	19.2
3/4	19 (12)	3/4-14	1 1/32	26.4	31/32	24.6
1	25 (16)	1-11	1 5/16	33.3	1 7/32	30.9
1 1/4	32 (20)	1 1/4-11	1 21/32	41.9	1 9/16	39.6
1 1/2	38 (24)	1 1/2-11	1 7/8	47.8	1 25/32	45.5
2	50 (32)	2-11	2 11/32	59.7	2 1/4	57.4

### JIS 30° female (cone) seat, parallel pipe threads (PT)

(Threads per JIS B 0202)

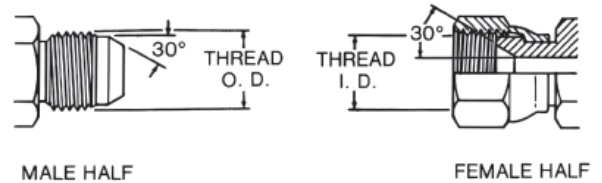

The Japanese JIS 30° flare is similar to the American SAE 37° flare connection in application as well as sealing principles. However, the

flare angle and dimensions are different. The threads are similar to BSPP.

Inch size	Dash size	Nominal thread size (similar to bspp)	Male thread O.D. inch		Female thread O.D. inch	
			fract.	dec.	fract.	dec.
mm	mm	-				
1/4	6 (04)	1/4-19	33/64	13.2	15/32	11.9
3/8	9 (06)	3/8-19	21/32	16.7	19/32	15.3
1/2	12 (08)	1/2-14	13/16	21.0	3/4	19.2
3/4	19 (12)	3/4-14	1 1/32	26.4	31/32	24.6
1	25 (16)	1-11	1 5/16	33.3	1 7/32	30.9
1 1/4	32 (20)	1 1/4-11	1 21/32	41.9	1 9/16	39.6
1 1/2	38 (24)	1 1/2-11	1 7/8	47.8	1 25/32	45.5
2	50 (32)	2-11	2 11/32	59.7	2 1/4	57.4

## Japanese connections

### JIS B 8363 4-bolt flange\*

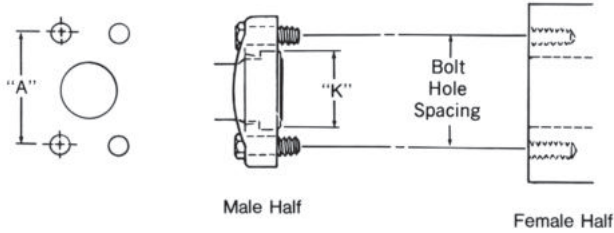

This connection is commonly used in fluid power systems. There are two pressure ratings. Type I (Code 61) is referred to as the "standard" series and Type II (Code 62) is the "6000 psi" series. The design concept for both series is the same, but the bolt hole spacing and flanged head diameters are larger for the higher pressure, Type II connection. Both metric and inch bolts are used. The female (port) is an unthreaded hole with four bolt holes in a rectangular

pattern around the port. The male consists of a flanged head, grooved for an O-Ring, and either a captive flange or split flange halves with bolt holes to match the port. The seal takes place on the O-Ring, which is compressed between the flanged head and the flat surface surrounding the port. The threaded bolts hold the connection together.

\*JIS B 8363, ISO/DIS 6162, DIN 20066, and SAE J518 are interchangeable, except for bolt sizes.

Size	Port hole	Bolt dimensions		Bolt hole spacing "A"	
		Type I (Cd.61)	Type II (Cd. 62)	Type I (Cd. 61)	Type II (Cd. 62)
mm(in) (dash)	mm(in)	mm(in)	mm(in)	mm(in)	mm(in)
12 (1/2) (08)	12,7 (0.50)	M8 x1.25 x 30 (5/16-18 x 1-1/4)	M8 x 1.25 x 30 (5/16-18 x 1-1/4)	38.1 (1.50)	40.49 (1.57)
16* (5/8) (10)	15,9 (0.63)	M8 x1.25 x 30 (5/16-18 x 1-1/4)	M8 x1.25 x 30 (5/16-18 x 1-1/4)	42.90 (1.69)	42.90 (1.69)
19 (3/4) (12)	19,1 (0.75)	M10 x 1.5 x 30 (3/8-16 x 1-1/4)	M10 x 1.5 x 40 (3/8-16 x 1-1/2)	47.63 (1.88)	50.80 (2.00)
25 (1) (16)	25,4 (1.00)	M10 x 1.5 x 30 (3/8-16 x 1-1/4)	M12 x 1.75 x 45 (7/16-14 x 1-3/4)	52.37 (2.06)	57.15 (2.25)
32 (1-1/4) (20)	31,7 (1.25)	M10 x 1.5 x 40 (7/16-14 x 1-1/2)	M14 x 2 x 45 (1/2-13 x 1-3/4)	58.72 (2.31)	66.68 (2.63)
38 (1-1/2) (24)	38,0 (1.50)	M12 x 1.75 x 40 (1/2-13 x 1-1/2)	M16 x 2 x 55 (5/8-11 x 2-1/4)	69.85 (2.75)	79.38 (3.13)
50 (2) (32)	50,8 (2.00)	M12 x 1.75 x 40 (1/2-13 x 1-1/2)	M20 x 2.5 x 70 (3/4-10 x 2-3/4)	77.77 (3.06)	96.82 (3.81)

\*This size 16 (5/8) is not available in any other 4 bolt flange offering.

Inch size	Flanged head dia. "K"			
	Type I bar (Cd.61)		Type II bar (Cd. 62)	
	mm	in	mm	in
1/2	30,18	1.19	31,75	1.25
5/8	34,20	1.35		
3/4	38,10	1.50	41,28	1.63
1	44,45	1.75	47,63	1.88
1 1/4	50,80	2.00	53,98	2.13
1 1/2	60,33	2.38	63,50	2.50
2	71,42	2.81	79,38	3.13

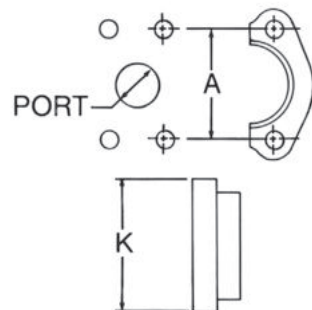

### JIS 210 Kgf/cm2 4-bolt square flange

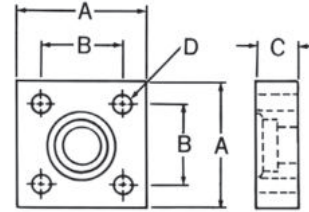

The JIS 4-bolt square flange connection is similar in concept to the SAE 4-bolt flange connection, except that the JIS bolt pattern is

square and the flange itself is different.

Size mm	Appx. inch size	Bolt size mm (bolt length for long (design))	Dim. "A" mm (inch)	Dim. "B" mm (inch)	Dim. "C" mm (inch)	Bolt hole dia "D" mm (inch)
12	1/2	M10 x 1.5 x 55 (80)	63 (2.48)	40 (1.57)	22 (0.87)	11 (0.43)
19	3/4	M10 x 1.5 x 55 (80)	68 (2.67)	45 (1.77)	22 (0.87)	11 (0.43)
25	1	M12 x 1.75 x 70 (100)	80 (3.15)	53 (2.09)	28 (1.10)	13 (0.51)
32	1 1/4	M12 x 1.75 x 70 (100)	90 (3.54)	63 (2.48)	28 (1.10)	13 (0.51)
38	1 1/2	M16 x 2.0 x 90 (130)	100 (3.94)	70 (2.76)	36 (1.42)	18 (0.71)
50	2	M16 x 2.0 x 90 (130)	112 (4.41)	80 (3.15)	36 (1.42)	18 (0.71)

### JIS 210 Kgf/cm2 O-Ring

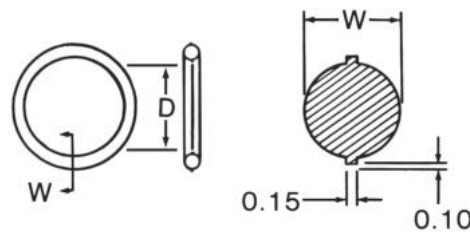

Nominal size mm	Dim. "D" mm	Dim. "W" mm
12	24.4 ± 0.15	3.1 ± 0.1
19	29.4 ± 0.15	3.1 ± 0.1
25	34.4 ± 0.15	3.1 ± 0.1
32	39.4 ± 0.15	3.1 ± 0.1
38	49.4 ± 0.15	3.1 ± 0.1
50	59.4 ± 0.15	3.1 ± 0.1

## O-Ring pilot thread sizes

This connection is common to air conditioning systems, both in vehicle and commercial applications. Both the male and female halves of the connections have a pilot, either long or short. The seal takes place by compressing an O-ring adjacent to the bead of the tube. The threads hold the connection together mechanically.

Size information		Male thread			Female thread		
Inch size	Dash size	O.D. (inch) nominal thread	O.D. (inch) fraction	O.D. (inch) decimal	I.D. (inch) nominal thread	I.D. (inch) fraction	I.D. (inch) decimal
3/8	06	5/8 - 18	5/8	0.62	5/8 - 18	9/16	0.57
1/2	08	3/4 - 18	3/4	0.75	3/4 - 16	11/16	0.69
5/8	10	7/8 - 18	7/8	0.87	7/8 - 14	13/16	0.81
3/4	12	1 1/16 - 16	1 1/16	1.06	1 1/16 - 14	1	0.99

Size information		Long pilot		Short pilot	
Inch size		Bead O.D.(inch)	Pilot length	Bead O.D. (inch)	Pilot length
3/8	06	0.52	0.28	0.52	0.19
1/2	08	0.64	0.39	0.64	0.19
5/8	10	0.77	0.39	0.77	0.19
3/4	12	0.91	0.39	0.91	0.19

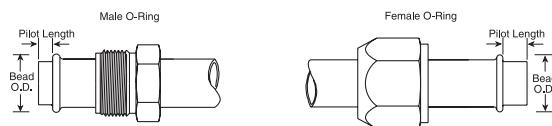

# Weatherhead

Thread engagement nominal dimensions

## Thread engagement

Dimensions may vary due to tolerance conditions. Listed below are the thread engagement dimensions (B) which must be taken into consideration when making connection with ports or appropriate female adapters. The "B" dimension must be subtracted from the overall length (A) to insure proper connection.

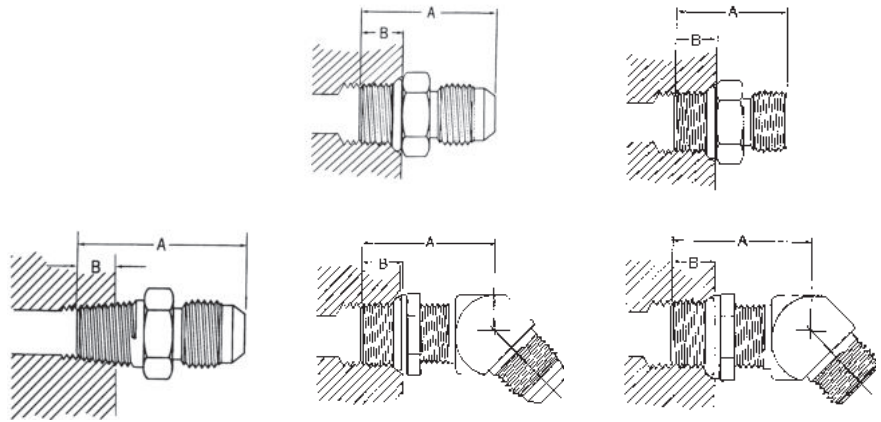

Dash size	Male pipe		SAE O-ring boss SAE J1926 with 37° flare J514		SAE O-ring boss SAE J1926 with ORS J1453	
	Straight and angled dimension "B"		Straight and adjustable dimension "B"		Straight and adjustable dimension "B"	
mm	mm	in	mm	in	mm	in
-02	6,4	0.25	-	-	-	-
-04	9,7	0.38	9,1	0.36	10,9	0.43
-05	-	-	9,1	0.36	10,9	0.43
-06	9,7	0.38	9,1	0.39	11,9	0.47
-08	12,7	0.50	10,9	0.43	14,0	0.55
-10	-	-	12,7	0.50	16,0	0.63
-12	15,7	0.62	15,0	0.59	18,5	0.73
-14	-	-	15,0	0.59	-	-
-16	17,5	0.69	15,0	0.59	18,5	0.73
-20	17,5	0.69	15,0	0.59	18,5	0.73
-24	17,5	0.69	15,0	0.59	18,5	0.73
-32	19,1	0.75	15,0	0.59	-	-

For ORS					
Dash size	Hole diameter	ORS bulkhead thickness			
		Min		Max	
	in	mm	in	mm	in
-04	0.575 +0.015/-0.000	5,1	0.20	12,7	0.50
-06	0.700 +0.015/-0.000	5,1	0.20	15,0	0.59
-08	0.825 +0.015/-0.000	5,6	0.22	15,0	0.59
-10	1.015 +0.015/-0.000	5,8	0.23	15,0	0.59
-12	1.200 +0.015/-0.000	6,4	0.25	15,0	0.59
-16	1.450 +0.015/-0.000	6,4	0.25	15,2	0.60
-20	1.715 +0.015/-0.000	6,4	0.25	15,2	0.60
-24	2.030 +0.015/-0.000	6,4	0.25	15,2	0.60

For 37° Flare									
Dash size	Hole diameter	37° bulkhead thickness straights				37° bulkhead thickness shapes			
		Min		Max		Min		Max	
	in	mm	in	mm	in	mm	in	mm	in
-03	0.391 +0.016/-0.000	1,3	0.05	10,4	0.41	3,3	0.13	6,4	0.25
-04	0.453 +0.016/-0.000	1,3	0.05	10,4	0.41	3,3	0.13	7,1	0.28
-05	0.516 +0.016/-0.000	1,3	0.05	10,4	0.41	3,3	0.13	7,1	0.28
-06	0.578 +0.016/-0.000	1,3	0.05	11,2	0.44	3,3	0.13	7,6	0.30
-08	0.766 +0.016/-0.000	1,3	0.05	11,2	0.44	4,1	0.16	8,6	0.34
-10	0.891 +0.016/-0.000	1,3	0.05	11,9	0.47	4,1	0.16	9,1	0.36
-12	1.076 +0.016/-0.000	1,3	0.05	11,9	0.47	4,1	0.16	9,7	0.38
-16	1.328 +0.016/-0.000	1,3	0.05	11,9	0.47	4,1	0.16	9,7	0.38
-20	1.656 +0.031/-0.000	1,3	0.05	11,9	0.47	4,1	0.16	9,7	0.38
-24	1.906 +0.031/-0.000	1,3	0.05	11,9	0.47	4,1	0.16	9,7	0.38

## Conversion table: Inch/Millimeter

Multiply inch x 25.4 =mm

Inches		
Fract.	Dec.	Dec.
1/64	0.016	0.397
1/32	0.031	0.794
3/64	0.047	1.191
1/16	0.063	1.588
5/64	0.078	1.984
3/32	0.094	2.381
7/64	0.109	2.778
1/8	0.125	3.175
9/64	0.141	3.572
5/32	0.156	3.969
11/64	0.172	4.366
3/16	0.188	4.763
13/64	0.203	5.159
7/32	0.219	5.556
15/64	0.234	5.953
1/4	0.250	6.350

Inches		
Fract.	Dec.	Dec.
17/64	0.266	6.747
9/32	0.281	7.144
19/64	0.297	7.541
5/16	0.313	7.938
21/64	0.328	8.334
11/32	0.344	8.731
23/64	0.359	9.128
3/8	0.375	9.525
25/64	0.391	9.922
13/32	0.406	10.319
27/64	0.422	10.716
7/16	0.438	11.113
29/64	0.453	11.509
15/32	0.469	11.906
31/64	0.484	12.303
1/2	0.500	12.700

Inches		
Fract.	Dec.	Dec.
33/64	0.516	13.097
17/32	0.531	13.494
35/64	0.547	13.891
9/16	0.563	14.288
37/64	0.578	14.684
19/32	0.594	15.081
39/64	0.609	15.478
5/8	0.625	15.875
41/64	0.641	16.272
21/32	0.656	16.669
43/64	0.672	17.066
11/16	0.688	17.463
45/64	0.703	17.859
23/32	0.719	18.256
47/64	0.734	18.653
3/4	0.750	19.050

Inches		
Fract.	Dec.	Dec.
49/64	0.766	19.447
25/32	0.781	19.844
51/64	0.797	20.241
13/16	0.813	20.638
53/64	0.828	21.034
27/32	0.844	21.431
55/64	0.859	21.828
7/8	0.875	22.225
57/64	0.891	22.622
29/32	0.906	23.019
59/64	0.922	23.416
15/16	0.938	23.813
61/64	0.953	24.209
31/32	0.969	24.606
63/64	0.984	25.003
1	1.000	25.400

## Conversion table: Pressure

(Per SAE J517 Section A)

Mpa	Bar	PSI
0.25	2.5	35
0.3	3	45
0.35	3.5	50
0.4	4	56
0.4	4	62
0.5	5	70
0.6	6	90
0.7	7	100
0.8	8	112
0.85	8.5	125
1	10	140
1.05	10.5	150
1.25	12.5	180
1.4	14	200
1.6	16	225
1.7	17	250
2.1	21	300
2.4	24	350
2.6	26	375
2.8	28	400
3.5	35	500
3.9	39	565

Mpa	Bar	PSI
4.2	42	600
4.3	43	625
4.9	49	700
5	50	725
5.2	52	750
5.6	56	800
6.1	61	875
7	70	1000
7.8	78	1125
8.4	84	1200
8.7	87	1250
9.8	98	1400
10	100	1450
10.5	105	1500
11.2	112	1600
11.3	113	1625
12.2	122	1750
14	140	2000
15.7	157	2250
16.8	168	2400
17.5	175	2500
19.2	192	2750

Mpa	Bar	PSI
20	200	2900
21	210	3000
22.4	224	3200
22.7	227	3250
24.5	245	3500
28	280	4000
29.7	297	4250
31.5	315	4500
33.5	335	4800
35	350	5000
38.5	385	5500
40	400	5800
42	420	6000
43.5	435	6250
45.5	455	6500
49	490	7000
52.5	525	7500
56	560	8000
59.5	595	8500
61	610	8750
63	630	9000
70	700	10000

Mpa	Bar	PSI
77	770	11000
78	780	11250
80	800	11600
84.0	840	12000
87	870	12500
98	980	14000
112	1120	16000
119	1190	17000
122	1220	17500
140	1400	20000
157	1570	22500
160	1600	23200
168	1680	24000
175	1750	25000
210	2100	30000
245	2450	35000
280	2800	40000
315	3150	45000
350	3500	50000

A new method for calculating the equivalent metric conversion to Mpa from psi was utilized. This method provides an extremely easy and consistent method of conversion to arrive at a rounded

metric units using 7 Mpa for each 1000 psi. The resulting Mpa pressure is never more than 1.7% higher than the mathematically correct Mpa unit when the pressure is higher than 250 psi. All

operating pressures of SAE J517 hoses are above 250 psi except for most of 100R4 and the 76mm (-48) and larger sizes of 100R5. Therefore all files of

previous test results should not be compromised



# Weatherhead

Assembly torque

## Recommended parallel connection assembly torque

Danfoss recommends that a torque wrench be used to assure proper fitting assembly of these connections.

The values listed are for steel connections. Contact Danfoss for torque values for other materials.

Straight thread O-Ring boss low pressure with 37° (SAEJ514)			
Dash size	Thread size (inches)	Jam nut or straight fitting torque lb.-ft.	Jam nut or straight fitting torque newton meters
-03	3/8-24	8-9	12-13
-04	7/16-20	13-15	18-20
-05	1/2-20	14-15	19-21
-06	9/16-18	23-24	32-33
-08	3/4-16	40-43	55-57
-10	7/8-14	43-48	59-64
-12	1 1/16-12	68-75	93-101
-14	1 3/16-12	83-90	113-122
-16	1 5/16-12	112-123	152-166
-20	1 5/8-12	146-161	198-218
-24	1 7/8-12	154-170	209-230
-32	2 1/2-12	218-240	296-325

Straight thread O-Ring boss high pressure with ORS (J1453)			
Dash size	Thread size (inches)	Jam nut or straight fitting torque lb.-ft.	Jam nut or straight fitting torque newton meters
-03	3/8-24	8-10	11-13
-04	7/16-20	14-16	20-22
-05	1/2-20	18-20	24-27
-06	9/16-18	24-26	33-35
-08	3/4-16	50-60	68-78
-10	7/8-14	72-80	98-110
-12	1 1/16-12	125-135	170-183
-14	1 3/16-12	160-180	215-245
-16	1 5/16-12	200-220	270-300
-20	1 5/8-12	210-280	285-380
-24	1 7/8-12	270-360	370-490

ORS			
Dash size	Thread size (inches)	Swivel nut torque lb.-ft.	Swivel nut torque newton meters
-04	9/16-18	10-12	14-16
-06	11/16-16	18-20	24-27
-08	13/16-16	32-35	43-47
-10	1-14	46-50	62-68
-12	1 3/16-12	65-70	88-95
-16	1 7/16-12	92-100	125-136
-20	1 11/16-12	125-140	170-190
-24	2-12	150-165	204-224

SAE 37° (JIC)				
Dash size	Thread size (inches)	Swivel nut torque lb.-ft.	Swivel nut torque newton meters	Hex turns*
-04	7/16-20	11-12	15-16	1 1/2 - 1 3/4
-05	1/2-20	15-16	20-22	1 1/2 - 1 3/4
-06	9/16-18	18-20	24-28	1 - 1 1/2
-08	3/4-16	38-42	52-58	1 1/4 - 1 3/4
-10	7/8-14	57-62	77-85	1 1/4 - 1 3/4
-12	1 1/16-12	79-87	108-119	1 - 1 1/2
-16	1 5/16-12	108-113	148-154	3/4 - 1
-20	1 5/8-12	127-133	173-182	1/2 - 3/4
-24	1 7/8-12	158-167	216-227	3/4
-32	2 1/2-12	245-258	334-352	1

\* Additional hex turns past hand tight



## Recommended parallel connection assembly torque (cont.)

Danfoss recommends that a torque wrench be used to assure proper fitting assembly of these connections.

Metric		
Thread size	Straight adapter or locknut torque	
	lb.-ft.	Newton meters
mm		
M10 x 1	13-15	18-20
M12 x 1.5	15-19	20-25
M14 x 1.5	19-23	25-30
M16 x 1.5	33-40	45-55
M18 x 1.5	37-44	50-60
M20 x 1.5	52-66	70-90
M22 x 1.5	55-70	75-95
M26 x 1.5	81-96	110-130
M27 x 2	96-111	130-150
M33 x 2	162-184	220-250
M42 x 2	170-192	230-260
M48 x 2	258-347	350-470

The values listed are for steel connections.

Contact Danfoss for torque values for other materials.

DKO, light series DIN 3865				
DN	O.D.	DKO, light series		
		Thread	SW torque definition 8434-1	Montage [Nm[ +10%]
5	6	M12X1,5	14	20
6	8	M14X1,5	17	25
8	10	M16X1,5	19	45
10	12	M18X1,5	22	50
12	15	M22X1,5	27	60
16	18	M26X1,5	32	70
20	22	M30X1,5	36	130
25	28	M36X1,5	41	180
32	35	M45X1,5	50	300
40	42	M52X1,5	60	320

BSPB		
Nominal thread size	Straight adapter or locknut torque	
	lb.-ft.	Newton meters
inches**		
G 1/8-28	13-15	18-20
G 1/4-19	19-23	25-30
G 3/8-19	33-40	45-55
G 1/2-14	55-70	75-95
G 3/4-14	103-118	140-160
G 1-11	162-184	220-250
G 1 1/4-11	170-192	230-260
G 1 1/2-11	258-347	350-470

\*\*\*G\* denotes parallel threads, other than ISO 6149. (Port connection only)

DKO, heavy series DIN 3865				
DN	O.D.	DKO, heavy series		
		Thread	SW torque definition 8434-1	Montage [Nm[ +10%]
	6	M14X1,5	17	20
5	8	M16X1,5	19	35
6	10	M18X1,5	22	50
8	12	M20X1,5	24	65
10	14	M22X1,5	27	70
12	16	M24X1,5	30	85
16	20	M30X2	36	135
20	25	M36X2	41 (46)	170
25	30	M42X2	50	280
32	38	M52X2	60	320

# Weatherhead

## Assembly instructions

### ORS Tube fittings, Pipe threads and SAE 37° (JIC) Flare type tube fittings

#### Assembly Instruction for ORS tube fittings

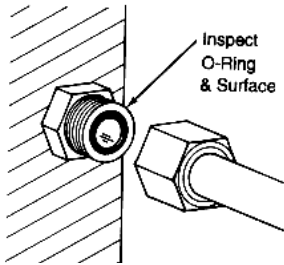

1. Inspect sealing surfaces and O-Ring groove for damage or foreign material. Check the O-Ring to insure that it is properly seated in the O-Ring groove.
2. Lubricate threads with heavy lubricant such as part number 222070 Lube.

3. Align the ORS tube fitting to the flat sealing connections and tighten the nut by hand. The nut should tighten easily by hand if properly aligned.

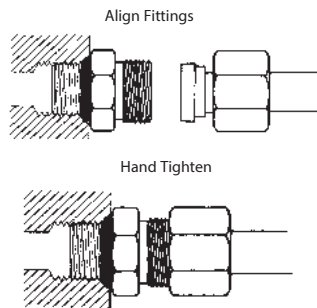

4. Complete the assembly by wrench tightening the nut to the recommended torque value on page 372.

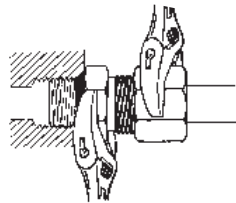

#### Assembly Instructions for Standard SAE 37° Flare type tube fitting

Use SAE J524 or SAE J525 tubing for best bending and flaring results.

1. Cut the tubing with a tube cutter. If a fine tooth hacksaw is used, make sure cut-off is square; remove burrs with deburring tool, emery paper or fine file. Clean all dirt and grit from the I.D. and O.D. of the tube.
2. Place the nut and then the sleeve onto tube. The threaded end of nut and flared end of sleeve must face the end of tube.

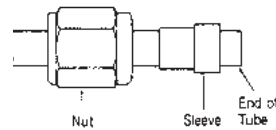

3. Flare the tube end with a flaring tool to provide a 37° flare. Check the flare for correct diameter, excessive thin out and burrs or cracks.
4. Lubricate all mating surfaces of nut, ferrule and body with a heavy lubricant such as part number 222070 Lube.
5. Assemble the nut and sleeve to body. Turn the nut hand tight then wrench tighten for a leakproof joint. See page 372, torque values, for assembly using a torque wrench.

The Danfoss standard 37° flare fitting is easy to disassemble and may be reassembled repeatedly.

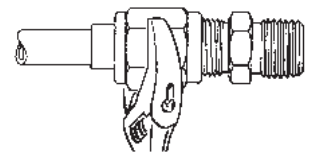

#### Assembly Instructions for Pipe threads

1. Assemble connection hand tight.
2. Mark male and female.
3. Rotate male; 1 1/2 turns if using thread sealant. 2 turns if not using thread sealant.

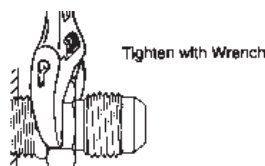
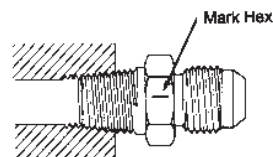
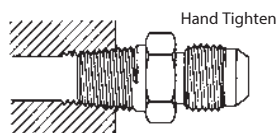

## Assembly instruction tips

### Terms

- Skive—Removal of the cover material exposing the reinforcement prior to fitting assembly.
- Dash Size—The hose or fitting size expressed in 1/16 of an inch. The numerator of a fraction whose denominator is 16. Example: -8 or -08 is  $8/16" = 1/2"$ .
- Nipple—The part of a hose fitting that goes into the hose tube.
- Socket—The part of a hose fitting that goes over the hose cover or reinforcement.
- Mandrel—A round, properly sized, steel bar used for support during assembly of the fitting or skiving the hose cover.
- Annular Rings—A series of concentric rings inside the socket.

### Reusable fitting tips to remember for easy assembly

- Part numbers and dash sizes are indicated on fitting sockets.
- It is essential the fitting be mated with a compatible hose style with the same dash size.
- Reusable fittings that have a notch in the socket serve as a reference for the cover skiving length.
- Familiarize yourself with the assembly instructions before you start to make an assembly.
- For hoses that require skiving, be sure to skive the hose to the proper length and down to the wire reinforcement.
- Use Danfoss 222070 hose assembly lube liberally on both the inside of the hose and on the fitting nipple. (Check for compatibility.)
- Always cut hose square
- For volume production of hose assemblies, use Danfoss Assembly Equipment.



### Cutting the hose

1. To determine the "J" length (cut length of hose) from "OA" (overall length) deduct "D" dimensions of both end fittings. Consult fitting information pages for "D" dimensions. For hose assemblies with SOCKETLESS fittings, add 1/2" to "J" length.  
 Tip: If the old Danfoss assembly was the right length, simply remove the hose fittings and measure the hose.
2. Cut the hose square.
3. Clean the hose bore.

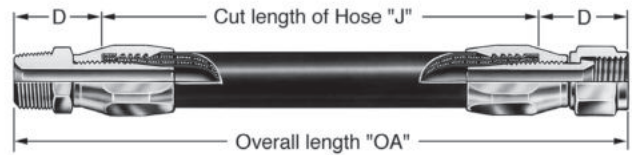

### Phase angle (offset)

When making double elbow assemblies, the following steps should be followed to obtain the desired angle between elbows. Tighten both elbows to maximum allowable gap between socket and nipple hex. Start to position for relative angle between elbows. Finish assembly by adjusting both elbows. Backing off to get desired angle should be avoided.

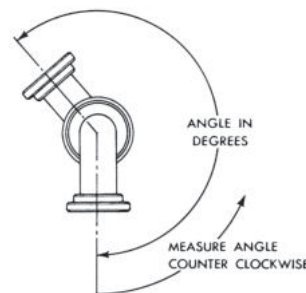

# Weatherhead

## Maintenance

### Cleaning, inspection, testing and storage



Clean



Inspect

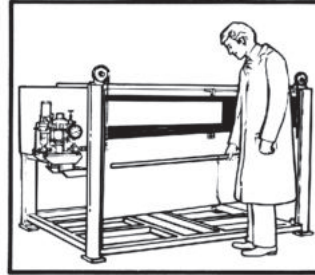

Proof test - hydrostatic

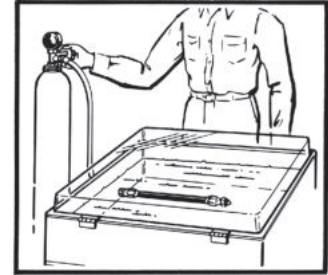

Proof test - pneumatic

#### Maintenance

Hose assemblies in operation should be inspected frequently for leakage, kinking, abrasion, corrosion or any other signs of wear or damage. Worn or damaged hose assemblies should be replaced immediately.

#### Clean

At minimum a hose assembly should be blown out with clean compressed air. Danfoss recommends using the **Danfoss Projectile Cleaning System** (FT1455 Series).

Assemblies may be rinsed out with mineral spirits if the tube stock is compatible with oil, otherwise hot water at +150°F max. may be used.

#### Inspect

Examine hose assembly internally for cut or bulged tube, obstructions, and cleanliness.

Check for proper gap between nut and socket or hex and socket. Nuts should swivel freely. Cap the ends of the hose with plastic covers to keep clean.

#### Proof test – hydrostatic

The hose assembly should be hydrostatically tested at twice the recommended working pressure of the hose.

Test pressure should be held for not more than one minute and not less than 30 seconds. When test pressure is reached, visually inspect hose assembly for: a) Any leaks or signs of weakness. b) Any movement of the hose fitting in relation to the hose. Any of these defects are cause for rejection.

(See Assembly Equipment Section for Danfoss Proof Test Stands.)

#### Proof test – pneumatic

Hose assemblies intended for gas or air service should be tested with air or nitrogen at 100 psi with the assembly immersed in water. Random bubbles may appear over the hose and fitting area when assembly is first pressurized. This should not be construed as a defect. However, if the bubbles persist in forming at a steady rate at any particular point on the hose, the assembly should be rejected.

Caution: Testing should be conducted in approved test stands with adequate guards to protect the operator.

#### Storage and handling

Hose should be stored in a dark, dry atmosphere away from electrical equipment, and the temperature should not exceed +90°F. Storage in the original shipping container is preferred.

## Hose and reusable fittings

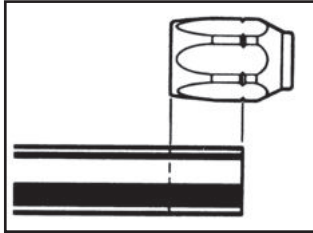

### Step 1

Cut hose to length required using a cut-off wheel. Clean hose bore.

Hose must be stripped of its rubber cover before inserting in socket. Locate skiving point by putting hose end next to socket as shown. Measure from hose end to notch on socket.

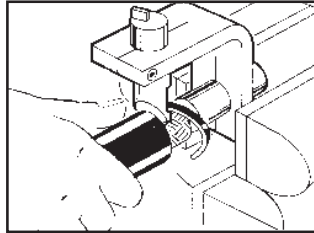

### Skive Tool

Use the correct size FT1229 hose cover skiving tool. Mount the tool in a vise. Push the hose over the mandrel. Rotate the hose clockwise until it bottoms or secure hose in a vise and attach FT1279 auger to the skive tool. Insert mandrel into the hose and rotate clockwise until it bottoms.

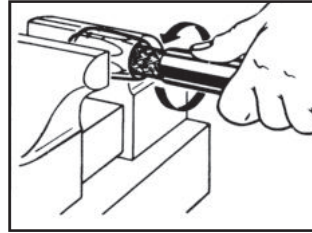

### Step 2

Put socket in vise.

Screw hose into socket counterclockwise until it bottoms.

When assembling long lengths of hose, it may be preferred to put hose in vise just tight enough to prevent from turning, and screw socket onto the hose counterclockwise until it bottoms.

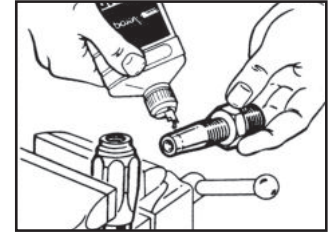

### Step 3

Lubricate nipple threads and inside of hose liberally. Use heavy oil or Danfoss 222070 hose assembly lube.

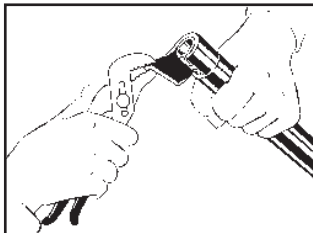

### Step Z

#### Skive Hose

By Hand: Cut rubber cover around down to wire reinforcement. Slit lengthwise. Raise flap and pull off with pliers. Clean excess rubber off wire reinforcement with wire brush or soft wire wheel. Do not fray or flare wire reinforcement when brushing.

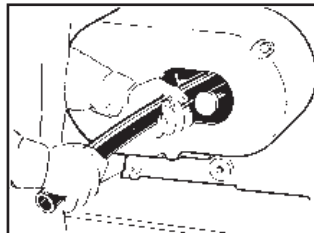

#### Machine

Use the S1102 cut-off and skiving machine. Consult the owners manual. Select the correct mandrel. Turn on the machine. Put the hose over the mandrel and rotate.

**When skiving, remove the rubber cover until the wire reinforcement is exposed around the circumference of the hose.**

**Sockets for hose fittings in the -16, -24 and -32 sizes are furnished with internal annular grooves in place of helical grooves (all FC310 and FC510 hose sockets are annular grooved). Install socket by pushing hose into socket with a back and forth rocking and twisting motion until hose bottoms on shoulder of socket.**

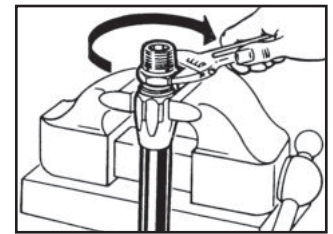

### Step 4

Screw nipple clockwise into socket and hose.

Leave 1/32" to 1/16" clearance between nipple hex and socket.

Recommendations for cleaning, inspection and testing are summarized on page 374. Disassemble in reverse order.

# Weatherhead

Hose and reusable fittings

## Hose and reusable fittings

H430, H430R

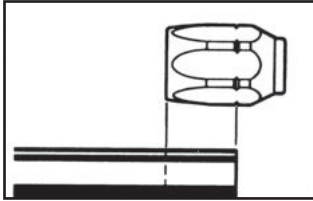

### Step 1

Cut hose to length required using a cut-off wheel. Clean hose bore.

Hose must be stripped of its rubber cover before inserting into socket. Locate skiving point by putting hose end next to socket as shown. Measure from hose end of socket to notch on socket.

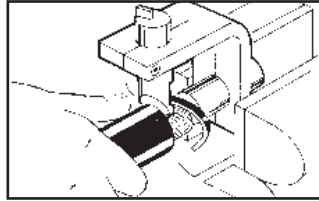

### Skive Tool

Use the correct size Danfoss FT1229 hose cover skiving tool. Mount the tool in a vise. Push the hose over the mandrel. Rotate the hose clockwise until it bottoms or secure hose in a vise and attach FT1279 auger to the skive tool. Insert mandrel into the hose and rotate clockwise until it bottoms.

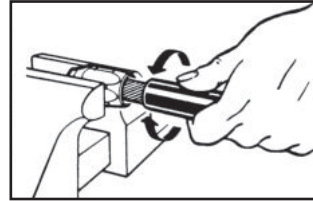

### Step 2

Sockets for hose fittings are furnished with internal annular grooved design. Install socket by pushing hose into socket with a back and forth rocking and clockwise twisting motion until hose bottoms on shoulder of socket.

An alternate method is to insert the hose in a vise. Install socket by pushing onto the hose with a back and forth rocking and clockwise twisting motion until the hose bottoms on the shoulder of socket.

A rawhide hammer or similar tool may be used to tap the socket onto the hose but avoid damage to internal socket threads. Be sure not to damage hose cover or wire reinforcement.

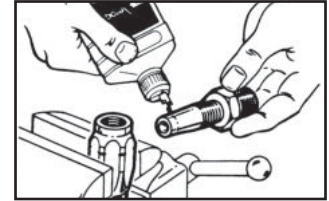

### Step 3

Liberalily lubricate nipple threads and inside of hose. Use heavy weight oil or Danfoss 222070 hose assembly lube.

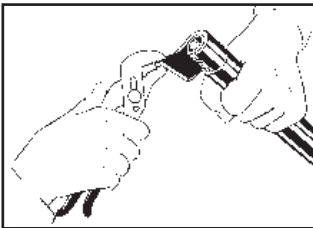

### Step Z

#### Skive hose by hand

Cut rubber cover around down to wire reinforcement with a knife. Slit lengthwise. Raise flap and pull off with pliers. Clean excess rubber off wire reinforcement with wire brush or soft wire wheel. Do not fray or flare wire reinforcement when brushing.

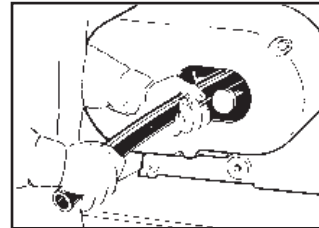

### Machine

Use the Danfoss S1102 cut-off and skiving machine. Consult the owners manual. Select the correct mandrel. Turn on the machine. Put the hose over the mandrel and rotate counterclockwise.

**when skiving, remove the rubber cover until the wire reinforcement is exposed around the circumference of the hose.**

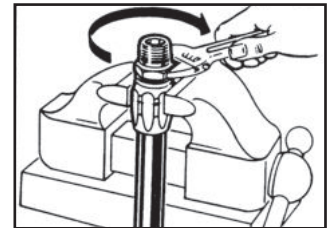

### Step 4

Screw nipple clockwise into socket and hose. Leave a 1/32" to 1/16" clearance between nipple hex and socket.

Recommendations for cleaning, inspection and testing are summarized on page 374. Disassemble in reverse order.

## Hose and reusable fittings

H180, H280, EC115, EC215, H190, H290

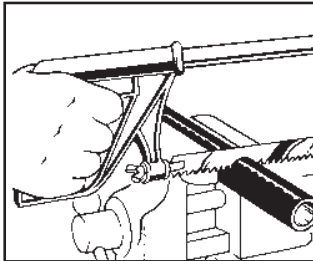

### Step 1

Cut hose to length required using a cut-off machine.  
Clean hose bore.

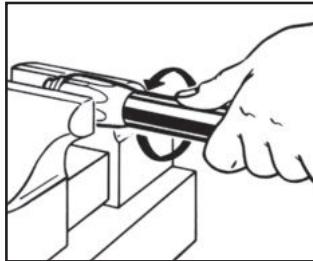

### Step 2

Liberaly lubricate hose cover with Danfoss 222070 hose assembly lube.

Place socket in vise and turn hose into socket counterclockwise until it bottoms.

When assembling long lengths of hose, it may be preferred to put hose in vise just tight enough to prevent from turning, and screw socket onto the hose counterclockwise until it bottoms.

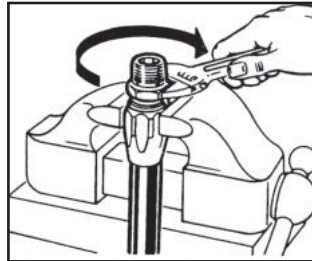

### Step 3

Liberaly lubricate nipple threads and inside of hose. Use heavy weight oil or Danfoss 222070 hose assembly lube.

### Step 4

Screw nipple clockwise into socket and hose. Leave 1/32" to 1/16" clearance between nipple hex and socket.

Recommendations for cleaning, inspection and testing are summarized on page 374.  
Disassemble in reverse order.



# Weatherhead

## Hose and reusable fittings

### Hose and reusable fittings

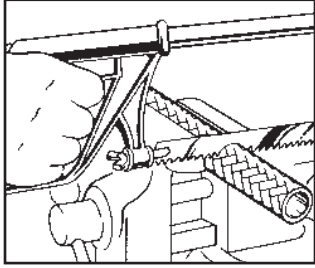

**Step 1**

Cut hose square to length required using a cut-off wheel. Clean hose bore.

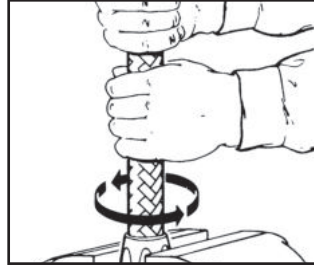

**Step 2**

Put socket in vise. Screw hose counterclockwise into socket until hose bottoms. Back off 1/4 turn.

When assembling long lengths of hose, it may be preferred to put hose in vise just tight enough to prevent from turning, and screw socket into the hose counterclockwise until it bottoms. Back off 1/4 turn.

Back off FC300, FC350 and FC355 hose 1/4 to 1/2 turn.

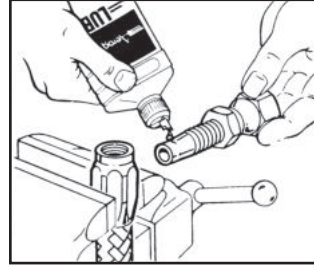

**Step 3**

MALE ENDS: Push assembly tool into nipple.

SWIVEL ENDS: Tighten nipple and nut on assembly tool.

Lubricate nipple, mandrel and inside of hose liberally. Use heavy oil or Danfoss 222070 hose assembly lube.

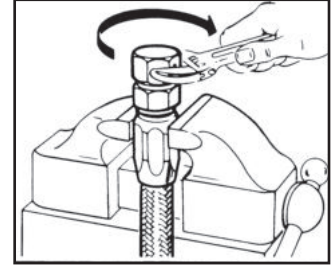

**Step 4**

MALE ENDS: Screw nipple clockwise into socket and hose. Leave a 1/32" to 1/16" clearance between nipple hex and socket.

SWIVEL ENDS: Screw nipple clockwise into socket and hose. Leave 1/32" to 1/16" clearance between nut and socket.

Recommendations for cleaning, inspection and testing are summarized on page 374. Disassemble in reverse order.



## Accessories

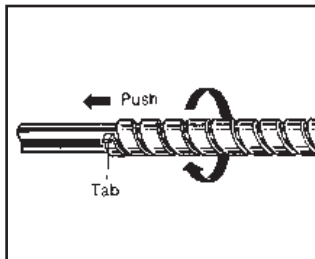

### Step 1

Follow the appropriate assembly instructions through the assembly of one end fitting. Insert one end fitting in vise.

### Step 2

Cut coil length. Coil should be cut to overall assembly length "OA" minus the sum of the overall length of each end fitting. ("A" dimension).

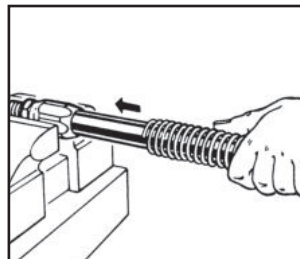

### Step 3

#### 3a) Steel Protective Coil Sleeve

The hose and the coil should be held straight. Taping or capping the hose end can prevent frayed wire ends from snagging on the coil. Bend one end to the coil outward to form a slight tab to assist grasping. (Cut off or bend back when installation is complete.) Hold the tab with the thumb of one hand while twisting the coil clockwise approximately one foot back from the coil tab. When the coil opens up sufficiently, slip the tab end to

the coil over the hose. Move the coil onto the hose by pulling at the tab end while pushing with the other hand. Be careful not to exceed the resiliency of the coil by stretching it too far.

#### 3b) Steel Protective Coil Spring

Slide coil over hose.

### Step 4

Proceed with assembly of second end fitting.

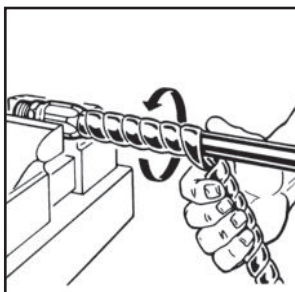

### Step 1

Follow the appropriate hose assembly instructions through the assembly of both end fittings. Insert end fitting in vise.

### Step 2

Cut coil length. Coil should be cut to overall assembly length "OA" minus the sum of the overall length of each end fitting. ("A" dimension).

### Step 3

Wrap the coil on the hose.

# Weatherhead

## Accessories

### Accessories

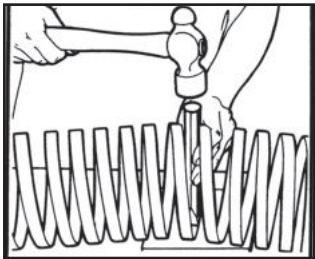

#### Step 1

Cut coil length. The coils should be cut to the hose length, minus the nipple intrusion. For any given hose assembly the support coil length equals the overall hose assembly length minus the sum of the overall lengths of each end fitting. ("A" dimensions.)

Small size of the coil can usually be cut with strap cutters or sheet metal shears. The larger sizes are best cut with a heavy sharp chisel or bolt cutter. With small sizes skip directly to Step 3.

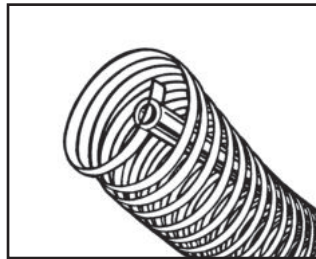

#### Step 2

Compress the coil (large sizes only). It is necessary to reduce the coil diameter slightly in order to insert it into the hose. The easiest approach is to use a length of pipe with a notch cut in one end. Clamp the plain end of the pipe in a vise, slide the coil over the pipe and insert the free end of the coil into the notched end of the pipe. Then clamp the coil and pipe firmly together. Twist the coil to compress it prior to installation into the hose.

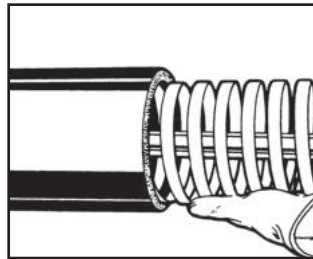

#### Step 3

**Small sizes:** The coil can be worked into the hose by hand without difficulty. Remove all burrs from the coil prior to insertion. This will prevent cutting of the hose tube. Position the coil midway between hose ends.

**Large sizes:** With the pipe still in position, as in Step 2, assemble the hose over the coil. With the coil fully centered in the hose, remove the pipe and clamp.

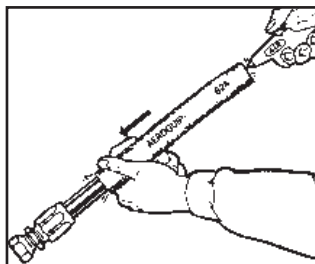

#### Step 1

Follow the appropriate hose assembly instructions through the assembly of one end fitting. Cut firesleeve to same length as hose; using Firesleeve End Dip (AE13702-003) dip ends of firesleeve to a depth of three quarters of an inch and allow to dry at room temperature.

Start firesleeve over cut end of hose.

**If applying sleeve over PTFE or stripped cover assemblies, wrap exposed wire with tape. Grasp sleeve and slip over the hose assembly as illustrated.**

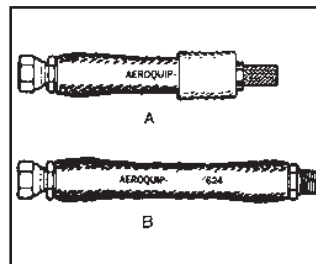

#### Step 2

Skin sleeve back from cut end of hose enough to allow assembly of second end fitting. (2A)

Then center sleeve so that it completely covers both sockets. (2B)

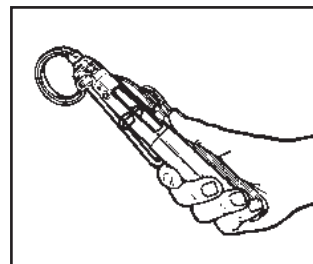

#### Step 3

Insert tail of band clamp into hand clamping tool.

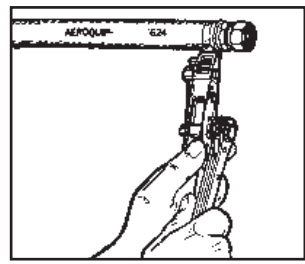

#### Step 4

Position band clamp over sleeve as shown and then draw tight with hand tool. Remove tool and cut free end of band clamp. Repeat on other end of assembly. To complete, bend protruding tail of clamp over clamp buckle. Also repair any scuffs or minor abrasions of firesleeve by brush application of End Dip AE13702-003.

Weatherhead by Danfoss

## Glossary & index



## Glossary

- abrasion:** external damage to a hose assembly caused by its being rubbed on a foreign object; a wearing away by friction.
- ABS:** Air-Brake Swivel absorption: regarding hose, the process of taking in fluid. Hose materials are often compared with regard to relative rates and total amounts of absorption as they pertain to specific fluids.
- acid resistant:** having the ability to withstand the action of identified acids within specified limits of concentration and temperature
- adapter, adaptor: 1)** fittings of various sizes and materials used to change an end fitting from one type to another type or one size to another. (i.e., a male SAE to male pipe adapter is often attached to a female SAE to create a male end union fitting); **2)** the grooved portion of a cam & groove coupling.
- adhesion:** the strength of bond between cured rubber surfaces or between a cured rubber surface and a non-rubber surface.
- adhesive:** a material which, when applied, will cause two surfaces to adhere.
- ambient temperature:** the temperature of the atmosphere or medium surrounding an object under consideration.
- ambient/atmospheric conditions:** The surrounding conditions, such as temperature, pressure, and corrosion, to which a hose assembly is exposed.
- amplitude of vibrations and/or lateral movement:** the distance a hose assembly deflects laterally to one side from its normal position, when this deflection occurs on both sides of the normal hose centerline.
- anchor:** a restraint applied to eliminate motion and restrain forces.
- annular:** refers to the convolutions on a hose that are a series of complete circles or rings located at right angles to the longitudinal axis of the hose (sometimes referred to as "bellows").
- anodize, anodized:** an electrolytic process used to deposit protective or cosmetic coatings in a variety of colors on metal; primarily used with aluminum.
- ANSI:** American National Standards Institute.
- application working pressure:** unique to customer's application. See pressure, working.
- application:** the service conditions that determine how a hose assembly will be used.
- armor:** a protective cover slid over and affixed to a hose assembly; used to prevent over bending or for the purpose of protecting hose from severe external environmental conditions such as hot materials, abrasion, or traffic.
- assembly:** a general term referring to any hose coupled with end fittings of any style attached to one or both ends.
- ASTM:** American Society for Testing and Materials.
- attachment:** the method of securing an end fitting to a hose (e.g., banding, crimping, swaging, or screw-together 2 piece or 3 piece-style field attachable fittings).
- axial movement:** compression or elongation along the longitudinal axis.
- backing:** a soft rubber layer between a hose tube and/or cover and carcass to provide adhesion.
- barb:** the portion of a fitting (coupling) that is inserted into the hose, usually comprised of two or more radial serrations or ridges designed to form a redundant seal between the hose and fitting.
- barbed and ferrule fitting:** a two-piece hose fitting comprised of a barbed insert (nipple), normally with peripheral ridges or backward-slanted barbs, for inserting into a hose and a ferrule; usually crimped or swaged.
- Barb-Tite:** a line of low pressure push-on brass hose end fittings that is a trademark of Danfoss Corporation.
- bend radius:** the radius of a bent section of hose measured to the innermost surface of the curved portion.
- bend radius, minimum:** the smallest radius at which a hose can be used. For metal hose: the radius of a bend measured to the hose centerline, as recommended by the manufacturer.
- blister:** a raised area on the surface or a separation between layers usually creating a void or air-filled space in a vulcanized article.
- blow out force:** the force generated from the internal pressure attempting to push the fitting from the hose.
- body wire:** normally a round or flat wire helix embedded in the hose wall to increase strength or to resist collapse.
- bore: 1)** an internal cylindrical passageway, as of a tube, hose or pipe; **2)** the internal diameter of a tube, hose, or pipe.
- braid:** the woven portion of a hose used as reinforcement to increase pressure rating and add hoop strength. Various materials such as polyester, cotton or metal wire are used. A hose may have one or more braids, outside or between layers of hose material.
- braid wear:** motion between the braid and corrugated hose, which normally causes wear on the outside diameter of the corrugation and the inside diameter of the braid.
- braided ply:** a layer of braided reinforcement.
- braid-over-braid:** multiple plies of braid having no separating layers.
- brand:** a mark or symbol identifying or describing a product and/or manufacturer, that is embossed, inlaid or printed.
- brass:** a family of copper/zinc alloys.
- brazing:** a process of joining metals using a non-ferrous filler metal having a melting point that is lower than the "parent metals" to be joined, typically over +800°F (+427°C).
- bronze:** an alloy of copper, tin and zinc.
- BSPP/BSPT:** British Standard Pipe Parallel / British Standard Pipe Tapered. See fitting/coupling — pipe thread fittings.
- carcass:** the fabric, cord and/or metal reinforcing section of a hose as distinguished from the hose tube or cover.
- chalking:** the formation of a powdery surface condition due to disintegration of surface binder or elastomer by weathering or other destructive environments.
- checking:** the short, shallow cracks on the surface of a rubber product resulting from damaging action of environmental conditions.
- chemical compatibility:** the relative degree to which a material may contact another without corrosion, degradation or adverse change of properties.
- chemical resistance:** the ability of a particular polymer, rubber compound, or metal to exhibit minimal physical and/or chemical property changes when in contact with one or more chemicals for a specified length of time, at specified concentrations, pressure, and temperature.
- cold flexibility:** relative ease of bending while being exposed to specified low temperature.
- collar: 1)** the portion of a fitting that is compressed by crimping to seal the hose onto the fitting barbs and create a permanent attachment; also called a ferrule. (With field attachable fittings, the lock and seal are accomplished mechanically by the collar without crimping); **2)** a raised portion on the hose shank which functions as a connection for a ferrule or other locking device or functions as a hose stop.
- collet:** a tool or die-set used to crimp a hose end fitting onto a hose. A crimping die-set is typically six to eight "fingers" designed for infinite diameter settings within a range or preset to a specific diameter for a given hose type and size. Some may have a replaceable cage.
- Coll-O-Crimp:** a line of hydraulic and pneumatic hose, hose end fittings, and fabrication equipment that is a registered trademark of Danfoss Corporation.
- combustible liquid:** a liquid having a flash point at or above +100°F (+37.8°C).



**compound:** the mixture of rubber or plastic and other materials, which are combined to give the desired properties when used in the manufacture of a product.

**compression fitting:** see fitting/coupling – compression

**conductive:** the ability to transfer electrical potential.

**configuration:** the combination of fittings on a particular assembly.

**convoluted:** description of hose or innercore having annular or helical ridges formed to enhance flexibility.

**core:** the inner portion of a hose, usually referring to the material in contact with the medium.

**corrosion:** the process of material degradation by chemical or electrochemical means.

**corrosion resistance:** ability of metal components to resist oxidation.

**corrugated hose:** hose with a carcass fluted, radially or helically, to enhance its flexibility or reduce its weight.

**coupling:** a frequently used alternative term for hose end fitting.

**cover:** the outer component usually intended to protect the carcass of a product.

**CPE:** chlorinated polyethylene, a rubber elastomer.

**cracking:** a sharp break or fissure in the surface, generally caused by strain and environmental conditions.

**crimp diameter:** the distance across opposite flats after crimping.

**crimp/crimping:** a hose end fitting attachment method utilizing a number of dies mounted in a radial configuration. The dies close perpendicular to the hose and fitting axis, compressing the collar, ferrule, or sleeve around the hose.

**cure:** the act of vulcanization. See vulcanization.

**cut off factor:** the hose length to be subtracted from the overall assembly length that allows for the hose coupling end connection extension beyond the end of the hose.

**date code:** any combination of numbers, letters, symbols or other methods used by a manufacturer to identify the time of manufacture of a product.

**deburr:** to remove ragged edges from the inside diameter of a hose end.

**design factor:** a ratio used to establish the working pressure of the hose, based on the burst strength of the hose.

**displacement:** the amount of motion applied to a hose defined as inches for parallel offset and degrees for angular misalignment.

**DOT:** Department of Transportation.

**DIN:** Deutsche Industrie Norme.

**duplex assembly:** an assembly consisting of two hose assemblies, one inside the other, and connected at the ends; also known as “jacketed assemblies.”

**durometer:** an instrument for measuring the hardness of rubber and plastic compounds.

**eccentricity:** the condition resulting from the inside and outside diameters not having a common center.

**effusion:** the escape, usually of gases, through a material. See permeation.

**elastic limit:** the limiting extent to which a body may be deformed and yet return to its original shape after removal of the deforming force.

**elastomer:** any one of a group of polymeric materials, usually designated thermoset, such as natural rubber, or thermoplastic, which will soften with application of heat.

**elongation:** the increase in length expressed numerically as a percentage of the initial length.

**EN:** European Normes

**ERMETO:** a steel fitting product trademarked by Danfoss Corporation.

**endurance test:** a service or laboratory test, conducted to product failure, usually under normal use conditions.

**EPDM:** Ethylene Propylene Diene Monomer; an elastomer.

**extrude/extruded/extrusion:** forced through the shaping die of an extruder; extrusion may have a solid or hollow cross section.

**fabric impression:** impression formed on the rubber surface during vulcanization by contact with fabric jacket or wrapper.

**fabricator:** the producer of hose assemblies.

**fatigue:** the weakening or deterioration of a material occurring when a repetitious or continuous application of stress causes strain, which could lead to failure.

**FDA:** United States Food and Drug Administration.

**fire sleeve:** slip-on or integrally extruded sleeve used to retard the effects of fire in certain applications; most often made with silicone and/or ceramic fiber.

**fitting/coupling:** a device attached to the end of the hose to facilitate connection. The following is only a partial list of types of fittings available.

- **banjo fitting:** a through bolted designed featuring a hollow circle or “donut” attached to one end of the fitting barb so that the inner diameter is along the hose axis.

- **compression fitting:** a fitting style that seals on a mating tube by compressing an internal ferrule against the tube O.D.

- **field attachable fitting:** a fitting designed to be attached to hose without crimping or swaging. This fitting is not always a reusable type fitting.

- **flange style fittings:** pipe flanges and flanged fitting standards are listed under ANSI B16.5. Flanges are rated for pressure and listed as “American Class 150, 300, 400, 600, 900, 1,500 or 2,500.” Pressure-temperature ratings can be obtained by consulting the ANSI specification or ASME B16.5 (American Society of Mechanical Engineers). Designs vary by neck and face style, or other dimensional changes based on use. Various finishes or grooves may be applied to the face for sealing on a gasket or o-ring. Bolt holes and other dimensions are per the ANSI standard.

- **inverted flare fitting:** a fitting consisting of a male or female nut, trapped on a tube by flaring the end of the tube material to either 37° or 45°.

- **JIC fittings:** Joint Industrial Council (no longer in existence). An engineering group that established an industry standard fitting design incorporating a 37° mating surface, male and female styles. These standards are now governed by SAE.

- **o-ring fittings:** a fitting that seals by means of an elastomeric ring of a specified material.

#### pipe thread fittings:

- **NPT:** National Pipe Taper. Pipe thread per ANSI B1.20.1

- **NPTF:** National Pipe Tapered for Fuels. (Same as above except dry-seal per ANSI B1.20.3)

- **NPSH:** National Pipe Straight Hose per ANSI B1.20.7

- **NPSM:** National Pipe Straight Mechanical. Straight thread per ANSI B1.20.1

- **NPSL:** National Pipe Straight Loosefit per ANSI B1.20.1

- **BSPP, BSPT:** British Standard Pipe Parallel, British Standard Pipe Taper. BS21-

- **quick connect fitting:** a fitting designed to quickly connect and disconnect. These fittings come in many styles and types.

- **split flange fitting:** a fitting consisting of a flange retainer and a flange of two halves. This design allows the flanges to be installed after the retainer has been attached to the hose, making the flange reusable. SAE code 61 and 62.

- **tube fitting:** a hose fitting of which the mating end conforms to a tube diameter. The mate or male end of a compression fitting.

**flammable gases/liquid/media:** a flammable gas, including liquefied gas, is one having a closed cup flash point below +100°F (+37.8°C) and a vapor pressure greater than 25 psi (174.2 KPa).

**flex cracking:** a surface cracking induced by repeated bending and straightening.

**flow rate:** a volume of media being conveyed in a given time period.

**fluid:** a gas or liquid medium.

**fluorocarbon:** an organic compound containing fluorine directly bonded to carbon. The ability of the carbon atom to form a large variety of structural chains gives rise to many fluorocarbons and fluorocarbon derivatives.

# Weatherhead

## Glossary

**FOR-SEAL:** a product name for a hose end configuration using an o-ring sealing method, trademarked by Danfoss Corporation.

**gpm:** gallons per minute.

**heat resistance:** the property or ability to resist the deteriorating effects of elevated temperatures.

**helix:** a shape formed by spiraling a wire or other reinforcement around the cylindrical body of a hose; typically used in suction hose.

**hose:** a flexible conduit consisting of a tube, reinforcement, and usually an outer cover.

**hydrostatic testing:** the use of liquid pressure to test a hose or hose assembly for leakage, twisting, and/or hose change-in-length.

**Hytrel:** registered trademark of Chemours.

**I.D.:** inside diameter.

**identification yarn:** a yarn of single or multiple colors, usually embedded in the hose wall, used to identify the manufacturer.

**impression:** a design formed during vulcanization in the surface of a hose by a method of transfer, such as fabric impression or molded impression.

**impulse:** an application of force in a manner to produce sudden strain or motion, such as hydraulic pressure applied in a hose.

**innertube:** the innermost layer of a hose; the hose material in contact with the medium.

**insert:** optional term for nipple. See nipple.

**interlocking clamp:** a clamp which engages the fitting in a manner which prevents the clamp from sliding off the fitting, typically a bolt or U-bolt style with interlocking fingers which engage an interlock ring on the fitting.

**interlocking ferrule:** a ferrule, which physically attaches to the fitting preventing the ferrule from sliding off the fitting.

**ISO:** International Organization for Standardization.

**jacket:** a seamless tubular braided or woven ply generally on the outside of a hose.

**JIC:** see fitting/coupling—JIC.

**kinking:** a temporary or permanent distortion of the hose induced by bending beyond the minimum bend radius.

**layline:** the line of printed information that runs parallel on the side of a manufactured hose giving details such as part number, psi rating, hose size, and manufacturing data.

**layer:** a single thickness of rubber or fabric between adjacent parts.

**loop installation:** the assembly is installed in a loop or “U” shape, and is most often used when frequent and/or large amounts of motion are involved.

**LPG, LP Gas:** liquefied petroleum gas.

**MAWP:** see pressure, maximum allowable working.

**mandrel built:** a hose fabricated and/or vulcanized on a mandrel.

**manufacturer’s identification:** a code symbol used on or in some hose to indicate the manufacturer.

**media, medium:** the substance(s) being conveyed through a system.

**NAHAD:** National Association of Hose & Accessories Distributors.

**Neoprene:** a registered trademark of Chemours.

**nipple:** the internal member or portion of a hose fitting.

**nitrile rubber (NB/Buna-N):** a family of acrylonitrile elastomers used extensively for industrial hose.

**nominal:** a size indicator for reference only.

**nomograph:** a chart used to compare hose size to flow rate to recommended velocity.

**non-conductive:** the inability to transfer an electrical charge.

**NPT/NPTF:** national pipe threads. See fitting/coupling — pipe thread fittings.

**nylon:** a family of polyamide materials.

**OAL:** see overall length

**O.D.:** outside diameter.

**OE/OEM:** original equipment manufacturer.

**oil resistance:** the ability of the materials to withstand exposure to oil.

**oil swell:** the change in volume of a rubber article resulting from contact with oil.

**operating conditions:** the pressure, temperature, motion, and environment to which a hose assembly is subjected.

**o-ring fitting:** see fitting/coupling—o-ring.

**overall length (OAL):** the total length of a hose assembly, which consists of the free hose length plus the length of the coupling(s).

**oxidation:** the reaction of oxygen on a material, usually evidenced by a change in the appearance or feel of the surface or by a change in physical properties.

**ozone cracking:** the surface cracks, checks, or crazing caused by exposure to an atmosphere containing ozone.

**ozone resistance:** the ability to withstand the deteriorating effects of ozone (generally cracking).

**permanent fitting:** the type of fitting which, once installed, may not be removed for re-use.

**permeation:** the process of migration of a substance into and through another, usually the movement of a gas into and through a hose material; the rate of permeation is specific to the substance, temperature, pressure, and the material being permeated.

**pin pricked:** perforations through the cover of a hose to vent permeating gases.

**pitch: 1)** the distance from one point on a helix to the corresponding point on the next turn of the helix, measured parallel to the axis; **2)** the distance between the two peaks of adjacent corrugation or convolution.

**plating:** a material, usually metal, applied to another metal by electroplating, for the purpose of reducing corrosion; typically a more noble metal such as zinc is applied to steel.

**ply:** an individual layer in hose construction.

**polymer:** a macromolecular material formed by the chemical combination of monomers, having either the same or different chemical compositions.

**pressure:** force ÷ unit area. For purposes of this document, refers to PSIG (pounds per square inch gauge).

**pressure drop:** the measure of pressure reduction or loss over a specific length of hose.

**pressure, burst:** the pressure at which rupture occurs.

**pressure, maximum allowable working:** the maximum pressure at which a hose or hose assembly is designed to be used. Abbreviated as MAWP.

**pressure, working:** the maximum pressure to which a hose will be subjected, including the momentary surges in pressure, which can occur during service. Abbreviated as WP.

**psi:** pounds per square inch.

**PVC:** polyvinyl chloride. A low cost thermoplastic material typically used in the manufacture of industrial hoses. The operating temperature range is -500°F to +1750°F (-295.5°C to +954.4°C).

**reinforcement:** the strengthening members, consisting of either fabric, cord, and/or metal, of a hose. See ply.

**reusable fitting/coupling:** see fitting/coupling—field attachable fittings.

**RMA:** The Rubber Manufacturers Association, Inc.

**SAE:** Society of Automotive Engineers.

**shank:** that portion of a fitting, which is inserted into the bore of a hose.

**skive:** the removal of a short length of cover and/or tube to permit the attachment of a fitting directly over the hose reinforcement.

**sleeve:** a metal cylinder, which is not physically attached to the fitting, for the purpose of forcing the hose into the serrations of the fitting.

**smooth bore:** a term used to describe the type of innercore in a hose.

**specification:** a document setting forth pertinent details of a product.

**spiral:** a method of applying reinforcement in which there is not interlacing between individual strands of the reinforcement.

**spring guard:** a helically wound component applied internally or externally to a hose assembly, used for strain relief, abrasion resistance, collapse resistance.

**standard:** a document, or an object for physical comparison, for defining product characteristics, products, or processes, prepared by a consensus of a properly constituted group of those substantially affected and having the qualifications to prepare the standard for use.

**static wire:** wire incorporated in a hose to conduct static electricity.

**stem:** see nipple.

**Sub-Zero:** a low temperature resistant hose that is a registered trademark of Danfoss Corporation.

**surge (spike):** a rapid and transient rise in pressure.

**swelling:** an increase in volume or linear dimension of a specimen immersed in liquid or exposed to a vapor.

**Thick-Flange:** a hose end fitting that is trademarked by Danfoss Corporation.

**tube:** the innermost continuous all-rubber or plastic element of a hose.

**tube fitting:** see fitting/coupling—tube.

**tubing:** a non-reinforced, homogeneous conduit, generally of circular cross-section.

**vacuum resistance:** the measure of a hoses ability to resist negative gauge pressure.

**vibration:** amplitude motion occurring at a given frequency.

**viscosity:** the resistance of a material to flow.

**vulcanization:** a process during which a rubber compound, through a change in its chemical structure, improves or extends elastic properties over a greater range of temperature.

**weathering:** the surface deterioration of a hose cover during outdoor exposure, as shown by checking, cracking, crazing and chalking.

**wire reinforced:** a hose containing wires to give added strength, increased dimensional stability and crush resistance. See reinforcement.

**working temperature:** the temperature range of the application; may include the temperature of the fluid conveyed or the environmental conditions the assembly is exposed to in use.

**WP:** working pressure.

# Weatherhead

## Index

1AAXXMPXX	142	4SXXCTEXX	207	6SXXFLAXX	189
1AXXMCCXX	142	4SXXCTFXX	208	6SXXFLXX	188
1RAXFJAX	145	4SXXCTGXX	209	00110-XXANZF	157
1RAXFJBX	146	4SXXCTX	203	1538	242
1RAXFJCX	146	4SXXDLBXX	218	1539	242
1RAXFJX	144	4SXXDLXX	217	1540	242
1RAXFRAX	147	4SXXDSAXX	221	03310-XXNZF	157
1RAXFRBX	148	4SXXDSBXX	222	4523-04006	294
1RAXFRCX	148	4SXXDSXX	220	4573-00000	295
1RAXFRX	147	4SXXEKXX	219	4574-01000	294
1RAXMJX	145	4SXXFHAXX	197	6203	242
1RAXMPX	144	4SXXFHBXX	198	6204	243
1SXXMCCXX	142	4SXXFHDXX	199	6205	242
1W sockets	226	4SXXFHEXX	200	6206	243
1WXXFHAXX	224	4SXXHFHXX	201	6207	242
1WXXFHBXX	225	4SXXFHGXX	202	6207 E.F.I. hose clamps	242
1WXXFHXX	224	4SXXFHXX	196	14211-XX-XXZF	167
1WXXMPXX	225	4SXXFLAXX	189	15611-FXX-XXZF	166
2RAXFJAX	150	4SXXFLBXX	190	16011-XX-XXZF	167
2RAXFJBX	151	4SXXFLDXX	190, 191	16711-XX-XXZF	166
2RAXFJCX	151	4SXXFLEXX	192	22012	233
2RAXFJX	149	4SXXFLFXX	193	22033	233
2RAXFRAX	152	4SXXFLGXX	194	22046	234
2RAXFRB8	153	4SXXFLHXX	195	22068	233
2RAXFRCX	153	4SXXFLXX	188	22546	234
2RAXFRX	152	4SXXJFXX	215	22617	233
2RAXMJX	150	4SXXKFXX	216	24211D-XX-XXSMZF	163
2RAXMPX	149	6SAXMPX	173	24211D-XX-XXZF	163
4SAXMPX	173	6SAXXFJAXX	177	24241-XX-XXHXXTZF	164
4SAXXFJAXX	177	6SAXXFJBXX	178	24241-XX-XXHXXZF	164
4SAXXFJBXX	178	6SAXXFJXX	176	24291-XX-XXHXXTZF	165
4SAXXFJCXX	176, 177, 179	6SAXXFRAXX	185	24291-XX-XXZF	165
4SAXXFJGXX	180	6SAXXFRBXX	186	26711D-XX-XXZF	159
4SAXXFJXX	176	6SAXXFRXX	184	26711-XX-XXZF	158
4SAXXFRAXX	185	6SXXBFAXX	213	26741-XX-XXHXXZF	160
4SAXXFRBXX	186	6SXXBFBXX	214	26791-XX-XXHXXZF	161
4SAXXFRCXX	187	6SXXBFXX	212	26791-XX-XXZF	161
4SAXXFRXX	184	6SXXCTAXX	204	222070	239, 294
4SAXXFSXX	182	6SXXCTBXX	205	222070-8	239
4SAXXMBXX	181	6SXXCTDXX	206	900564	236
4SAXXMJXX	175	6SXXCTEXX	207	900705-25	236
4SAXXMRXX	183	6SXXCTFXX	208	900705-35	236
4SAXXPSXX	174	6SXXCTGXX	209	900705-45	236
4SXXBFAXX	213	6SXXCTX	203	A1900	236
4SXXBFBXX	214	6SXXDSAXX	221	A1900-20	236
4SXXBFXX	212	6SXXDSBXX	222	A1901	236
4SXXBPXX	211	6SXXDSXX	220	A1901-20	236
4SXXBTXX	210	6SXXFHAXX	197	A1902	236
4SXXCTAXX	204	6SXXFHBXX	198	A1902-20	236
4SXXCTBXX	205	6SXXFHGXX	202		
4SXXCTDXX	206	6SXXFHXX 1	96		



A1903 .....	236	A4927 .....	246	ET4001P-002 .....	287
A1903-20 .....	236	A4928 .....	246	ET5050 .....	280
A1904 .....	236	A5950 .....	238	ET9000 .....	298
A1904-20 .....	236	A5953 .....	238	ET9000C .....	303
A1905 .....	236	A5962 .....	238	ET9100 .....	299
A1905-20 .....	236	A5969 .....	238	ET9100C .....	303
A1906 .....	236	A5975 .....	238	ET9200 .....	300
A1906-20 .....	236	A5984 .....	238	ET9200C .....	302, 303
A1907 .....	236	A5987 .....	238	ET9300 .....	301
A1907-20 .....	236	A6900W .....	238	ET9300C .....	302, 303
A1908 .....	236	A6908 .....	238	ET9500C .....	302, 303
A1908-20 .....	236	A6910 .....	238		
A1910 .....	236	A6912 .....	238	F2015 .....	292
A1910-20 .....	236	A6914 .....	238	F2636 .....	239
A1912 .....	236	A6916 .....	238	FC-16X .....	326
A1913 .....	236	A6920 .....	238	FC2119-XX-449 .....	230
A1916 .....	236	A6924 .....	238	FF00000 .....	328
A1917 .....	236	A6928 .....	238	FF593-XX .....	229
A1919 .....	236	A6932 .....	238	FF595-XX .....	229
A2900 .....	236	A6936 .....	238	FF9217 .....	239
A2901 .....	236	A9900 .....	237	FF9446 .....	234
A2906 .....	236	A9901 .....	237	FF9807 .....	234
A2907 .....	236	A9902 .....	237	FF9855 .....	234
A2908 .....	236	A9903 .....	237	FF9895 .....	232
A2909 .....	236	A9904 .....	237	FF13267 .....	245
A2910 .....	236	A9905 .....	237	FF13268 .....	245
A2911 .....	236	Abrasion sleeve .....	237	FF13269 .....	245
A2912 .....	236	All stainless steel clamps .....	243	FF13270 .....	245
A2913 .....	236	Assembly lube .....	239	FF13271 .....	245
A2917 .....	236			FF13272 .....	245
A2919 .....	236	Band style clamp .....	239	FF13273 .....	245
A3900 .....	237	Band style clamp tool .....	239	FF13570 .....	245
A3901 .....	237	Bundling sleeves .....	246	FF13571 .....	245
A3902 .....	237	Bundling straps .....	247, 248	FF14802 .....	239
A3903 .....	237			FF16087-01 .....	232
A3904 .....	237	C-15X .....	326	FF17266 .....	328
A3905 .....	237	C-40X .....	326	FF90308 .....	244
A3906 .....	237	C-63X .....	326	FF90311 .....	241
A3907 .....	237	C-632X .....	327	FF90519 .....	248
A3908 .....	237			FF90523 .....	249
A4900 .....	237	EC115 .....	66	FF90645 .....	328
A4901 .....	237	EC118 .....	68	FF90646 .....	328
A4902 .....	237	EC215 .....	67	FF90754 .....	240
A4903 .....	237	EC415 .....	69	FF91420 .....	328
A4904 .....	237	EC420 .....	70	FF91475 .....	328
A4905 .....	237	ET1000 .....	268	FF91610 .....	328
A4906 .....	237	ET1187 .....	266	FH-40X .....	326
A4907 .....	237	ET4001 .....	278	FH-72X .....	327
A4908 .....	237			FH-135X .....	326
A4910 .....	237			Firesleeve .....	238
A4926 .....	246				

**Weatherhead**

## Index

Firesleeve tape .....	238
Flaretite seals .....	245
Flat-wire spring guard .....	236
FT1038A .....	292
FT1058 .....	305
FT1081 .....	294
FT1261 .....	304
FT1312 .....	304
FT1341 .....	239, 295
FT1355 .....	313, 316
FT1380 .....	270
FT1380DR-12 .....	327
FT1380e .....	270
FT1390 .....	274
FT1455 .....	306
FT1555 .....	320
Guardian Sleeve .....	240
H039 .....	60
H039H .....	61
H145 .....	54
H145R .....	40
H180 .....	39
H190 .....	52
H190H .....	41
H245L .....	45
H280 .....	42
H290 .....	53, 54
H290H .....	44
H400 .....	55, 56
H421 .....	57
H430 .....	46
H430R .....	47
H464 .....	59
H471 .....	49
H525H .....	48
H545 .....	55
H600 .....	51
H810L .....	50
H850 .....	58
H881 .....	43
HD-1X .....	327
HD-2X .....	327
Heavy duty hose suppor clamps .....	241
Heavy-duty poly hose guard .....	237
HK0509 .....	241
HK0709 .....	241
HK0809 .....	241
HK0913 .....	241
HK1013 .....	241
HK1113 .....	241
HK1213 .....	241
HK1313 .....	241
HK1413 .....	241
HK1513 .....	241
HK1613 .....	241
HK1713 .....	241
HK1813 .....	241
HK1913 .....	241
HK2017 .....	241
HK2117 .....	241
HK2317 .....	241
HK2517 .....	241
HK2617 .....	241
HK2917 .....	241
HK3117 .....	241
HK3217 .....	241
HK3317 .....	241
HK3417 .....	241
HK3817 .....	241
HLM-48 .....	244
Hose bend restrictors .....	238
Hose insertion gauge .....	244
Hose looms .....	244
Hose spacers .....	244
HP4 .....	244
HP6 .....	244
HP8 .....	244
HP10 .....	244
HP12 .....	244
HPMB .....	244
HPMO .....	244
HP Series .....	244
HSM-48 .....	244
Locater clamps .....	237
O-Rings .....	231
O-Rings & kits .....	233
Partial stainless steel clamps .....	242
Pressure gauge kit .....	239
Round-wire clamps .....	242
Round-wire spring guard .....	236
Split flange kits .....	229
Split flanges .....	228
Support Clamp .....	241
T-191 .....	295
T-400-54C .....	283
T-400-56C .....	283
T-400-57C .....	283
T-400-58C .....	283
T-400-59C .....	283
T-400-60C .....	283
T-400-61C .....	283
T-400-66 .....	283
T-400-MK .....	290
T-402-2 .....	288
T-403-2 .....	286
T-420 .....	272
T-420-GT .....	290
T-420-KK .....	290
T-420-PK .....	291
T-421-FP .....	289
T-421U .....	287
T-421U-110 .....	287
T-441 .....	288
T-460-2 .....	286
T-462-2 .....	289
T-480-2 .....	286
T-480-3 .....	289
T-481-110 .....	287
T-482-2 .....	288
TC-20 .....	327
Thread measuring kit .....	239
WH004 .....	71
XXZ-0XA .....	134
XXZ-0XC .....	131
XXZ-0XD .....	132
XXZ-0XE .....	136
XXZ-0XF .....	138
XXZ-0XL .....	129

XXZ-0XPA .....	123	XXZ-13X .....	78	XXZ-BC7X .....	141
XXZ-0XS .....	119	XXZ-15X .....	127	XXZ-BC8X .....	142
XXZ-1XA .....	134	XXZ-16X .....	127	XXZ-BC9X .....	142
XXZ-1XC .....	131	XXZ-17X .....	127	XXZ-E6X .....	100
XXZ-1XD .....	132	XXZ-20X .....	80	XXZ-E7X .....	100
XXZ-1XE .....	136	XXZ-21X .....	80	XXZ-E8X .....	100
XXZ-1XF .....	138	XXZ-25X .....	81	XXZ-G0X .....	110, 116
XXZ-1XK .....	130	XXZ-26X .....	81	XXZ-G1X .....	110
XXZ-1XL .....	129	XXZ-30X .....	94	XXZ-G2X .....	110
XXZ-1XPA .....	123	XXZ-31X .....	94	XXZ-G3X .....	110
XXZ-1XS .....	119	XXZ-35X .....	124	XXZ-G4X .....	112
XXZ-2XA .....	134	XXZ-36X .....	124	XXZ-G5X .....	112
XXZ-2XC .....	131	XXZ-37X .....	124	XXZ-G6X .....	112, 117
XXZ-2XD .....	132	XXZ-40X .....	91	XXZ-G7X .....	115
XXZ-2XE .....	136	XXZ-41X .....	91	XXZ-G8X .....	115
XXZ-2XF .....	138	XXZ-44X .....	93	XXZ-G9X .....	115, 118
XXZ-2XK .....	130	XXZ-48X .....	92	XXZ-H0X .....	111
XXZ-2XL .....	129	XXZ-50X .....	90	XXZ-H5X .....	113
XXZ-3XA .....	134	XXZ-51X .....	90	XXZ-H6X .....	114
XXZ-3XC .....	131	XXZ-52X .....	90	XXZ-J0X .....	79
XXZ-3XF .....	138	XXZ-60X .....	84	XXZ-J1X .....	79
XXZ-3XK .....	130	XXZ-61X .....	84	XXZ-J3X .....	98
XXZ-3XT .....	121	XXZ-62X .....	85	XXZ-J4X .....	98
XXZ-4XP .....	125	XXZ-63X .....	85	XXZ-J5X .....	98
XXZ-4XT .....	121	XXZ-64X .....	89	XXZ-L2X .....	86
XXZ-05X .....	82	XXZ-65X .....	89	XXZ-L6X .....	96
XXZ-5XC .....	135	XXZ-66X .....	88	XXZ-L7X .....	96
XXZ-5XD .....	133	XXZ-67X .....	88	XXZ-L8X .....	96
XXZ-5XE .....	137	XXZ-68X .....	87	XXZ-M0X .....	83
XXZ-5XP .....	125	XXZ-69X .....	87	XXZ-M1X .....	83
XXZ-5XT .....	121	XXZ-75X .....	104	XXZ-P0X .....	101
XXZ-6PW .....	122	XXZ-76X .....	104	XXZ-P1X .....	101
XXZ-06X .....	82	XXZ-77X .....	104	XXZ-P2X .....	101
XXZ-6XC .....	135	XXZ-95X .....	105	XXZ-P5X .....	128
XXZ-6XD .....	133	XXZ-97X .....	106	XXZ-P6X .....	128
XXZ-6XE .....	137	XXZ-A2X .....	97	XXZ-R0X .....	102
XXZ-6XP .....	125	XXZ-A3X .....	97	XXZ-R1X .....	102
XXZ-6XT .....	121	XXZ-A4X .....	97	XXZ-R6X .....	103
XXZ-07X .....	82	XXZ-A6X .....	99	XXZ-R7X .....	103
XXZ-7XC .....	135	XXZ-A7X .....	99	XXZR-10X .....	78
XXZ-7XD .....	133	XXZ-A8X .....	99	XXZR-11X .....	78
XXZ-7XE .....	137	XXZ-B0X .....	107	XXZR-60X .....	84
XXZ-7XP .....	126	XXZ-B1X .....	107	XXZR-61X .....	85
XXZ-8XC .....	135	XXZ-B4X .....	108	XXZ-S6X .....	95
XXZ-8XD .....	133	XXZ-B6X .....	109	XXZ-57X .....	95
XXZ-8XP .....	126	XXZ-BC0X .....	139	XXZ-58X .....	95
XXZ-9XP .....	126	XXZ-BC1X .....	139	XXZ-T0X .....	120
XXZ-10X .....	78	XXZ-BC4X .....	140	XXZ-T1X .....	120
XXZ-11X .....	78	XXZ-BC5X .....	140		
XXZ-12X .....	78	XXZ-BC6X .....	141		



ENGINEERING  
TOMORROW



**Danfoss Power Solutions**, Nordborgvej 81, 6430 Nordborg, Denmark, Tel. +45 74 88 22 22, Fax +45 74 65 25 80  
[www.danfoss.com](http://www.danfoss.com), E-mail: [info@danfoss.com](mailto:info@danfoss.com)

Any information, including, but not limited to information on selection of product, its application or use, product design, weight, dimensions, capacity or any other technical data in product manuals, catalogues descriptions, advertisements, etc. and whether made available in writing, orally, electronically, online or via download, shall be considered informative, and is only binding if and to the extent, explicit reference is made in a quotation or order confirmation. Danfoss cannot accept any responsibility for possibly errors in catalogues, brochures, videos and other material. Danfoss reserves the right to alter its products without notice. This also applies to products ordered but not delivered provided that such alterations can be made without changes to form, fit or function of the product. All trademarks in this material are property of Danfoss A/S or Danfoss group companies. Danfoss and the Danfoss logo are trademarks of Danfoss A/S. All rights reserved.